

2018 Leak Abatement Compliance Plan

SB 1371

SOUTHERN CALIFORNIA GAS COMPANY



Jimmie I. Cho
Senior Vice President
Gas Engineering &
Distribution Operations
555 W. 5th Street, M.L GT-21C3
Los Angeles, CA 90013-1011

Mr. Fred Hanes
Senior Utilities Engineer
Risk Assessment and Safety Advisory Section
Safety and Enforcement Division
California Public Utilities Commission
505 Van Ness Avenue, 2nd Floor
San Francisco, CA 94102

Dear Mr. Hanes:

Southern California Gas Company (SoCalGas) submits its 2018 Leak Abatement Compliance Plan per California Public Utilities Commission (CPUC) Decision (D.) 17-06-015, Ordering Paragraph 6, implementing Senate Bill 1371. Per the Commission's direction and in the May 8, 2017 letter, the operator must submit an overall program summary highlighting their major efforts to reduce methane emissions and estimated incremental costs where known. This Section should summarize the total anticipated emission reductions from the proposed practice projected for the two-year compliance period and, if possible through the year 2030.

SoCalGas' 2018 Leak Abatement Compliance Plan encompasses proposed activities to achieve methane emission reductions through the 26 Best Practices adopted in D.17-06-015. Proposed activities were evaluated for cost-effectiveness and emissions reduction opportunity, where data was available. Milestones were developed to achieve those emission reductions and develop a timeline for implementation. Activities include policy and procedure development, training development and deployment, increased leak surveys, installation of methane sensing technologies, faster leak repair times, capture of blowdown gas, replacement of high-bleed pneumatic devices, expansion of dig-alert programs, back-office information technology projects, and development of tools to support monitoring, record-keeping, and reporting.

Table 1, Major Efforts to Reduce Emissions, summarizes SoCalGas' proposed major activities, estimated costs, and estimated emissions reductions proposed in the 2018 SoCalGas Leak Abatement Compliance Plan.

Table 1: Major Efforts to Reduce Emissions

Best Practice	Activity	Estimated Compounded Emissions Reduction 2018-2019 (MCF)	Estimated Rate Recovery 2018-2019 (\$)	Estimated Compounded Emission Reduction 2018-2030 (MCF)	Estimated Rate Recovery 2018-2030 (\$)	Estimated Cost Benefits 2018-2030 † (\$)	Estimated Cost Effectiveness 2018-2030 (\$/MCF)
15	Three Year Leak Surveys	12,066	\$15,264,918	193,106	\$91,589,508	\$806,510	\$470
Pre-1986 Aldyl A	Annual Surveys on Pre-1986 Aldyl A	84,329	*GRC	1,046,095	*GRC	*GRC	*GRC
16	Annual Surveys on Unprotected Steel Pipe	112,707	\$8,047,286	1,264,425	\$48,283,716	\$5,177,935	\$34
20a	Prioritizing Repair of Large Leaks	243,630	\$3,994,978	1,461,780	\$23,969,868	\$5,806,462	\$12
21	Repairing Code 3 Steel Leak Inventory	241,370	\$34,268,672	1,448,220	\$205,612,032	\$5,752,599	\$138
23	Reduce Blowdown Emissions	90,248	\$18,434,796	541,488	\$110,608,776	\$2,150,891	\$200
23	Replacement of High Bleed Pneumatic Valves	10,040	\$79,652	129,618	\$477,912	\$538,027	\$0
23	Calibration Adjustment Factor In lieu of Meter Replacement	106	\$1,121,184	1,272	\$1,121,184	\$545 + TBD‡	\$0
23	Alternative Accuracy Test That Does Not Require Field Meter Removal	5	\$0	60	\$0	\$26	\$0
24	Expand Public Awareness Program	5,423	\$2,772,144	65,076	\$16,632,684	\$37,323	\$252
Total		799,924	\$83,983,630	6,151,140	\$498,295,680	\$20,269,773	

In addition to the major efforts in Table 1, a variety of research, development, and demonstration (RD&D) projects are referenced in specific Best Practices that are currently in progress, where SoCalGas is a direct funder or provides in-kind support. These projects were proposed and initiated by leading industry organizations including SoCalGas in response to this proceeding and other environmental regulations targeting overall reduction of natural gas emissions. Additional RD&D projects and pilot studies are also proposed where tools and technologies require further development, or where knowledge and information is needed to understand the potential for emissions reduction and to estimate the cost of implementation for SoCalGas.

SoCalGas appreciates the opportunity to submit its 2018 Leak Abatement Compliance Plan and looks forward to continuing to work with the CPUC and its staff to further the goals of Senate Bill 1371 in safe and cost-effective manner.

Sincerely,

/s/ Jimmie I. Cho

Jimmie Cho
Senior Vice President Gas Engineering & Distribution Operations

*GRC indicates recovery for this activity is being requested in SoCalGas' 2019 General Rate Case Application.

†Cost Benefits are based on gas savings resulting from reduced emissions, evaluated at WACOG forecasts published in the 2016 California Gas Report.

‡ SoCalGas anticipates substantial savings in operational and capital costs resulting from this policy change due to reduced labor needed for meter replacements and reduced capital needed for replacement meters, as further described in Best Practice 23.

Table of Contents

Best Practice 1: Compliance Plan.....	1
Best Practice 2: Methane GHG Policy	8
Best Practice 3: Pressure Reduction Policy.....	14
Best Practice 4: Project Scheduling Policy	20
Best Practice 5: Methane Evacuation Procedures.....	26
Best Practice 6: Methane Evacuation Work Orders Policy	32
Best Practice 7: Bundling Work Policy	38
Best Practice 8: Company Emergency Procedures	44
Best Practice 9: Recordkeeping	50
Best Practice 10: Minimize Uncontrolled Natural Gas Emissions Training.....	55
Best Practice 11: Methane Emissions Minimization Policies Training.....	59
Best Practice 12: Knowledge Continuity Training Programs.....	63
Best Practice 13: Performance Focused Training Program.....	67
Best Practice 14: Experienced, Trained Personnel	72
Best Practice 15: Gas Distribution Leak Surveys.....	77
Best Practice 16: Special Leak Surveys.....	86
Best Practice 17: Enhanced Methane Detection	94
Best Practice 18: Stationary Methane Detectors.....	100
Best Practice 19: Above Ground Leak Surveys	105
Best Practice 20a: Quantification.....	110
Best Practice 20b: Geographic Tracking	118
Best Practice 21: Find It, Fix It.....	123
Best Practice 22: Pipe Fitting Specifications	129
Best Practice 23: Minimize Emissions from Operations, Maintenance, and Other Activities.....	133
Best Practice 24: Dig-Ins and Public Education Program	151
Best Practice 25: Dig-Ins and Company Standby Monitors	158
Best Practice 26: Dig-Ins and Repeat Offenders	162

Table of Attachments

Attachment A: Red-lined Environmental Excellence Policy	167
Attachment B: Sempra Environmental Policy	169
Attachment C: Sempra Corporate Responsibility Report	171
Attachment D: Red-lined draft of Gas Standard 184.06	259
Attachment E: Red-lined draft of Gas Standard 182.0160	272
Attachment F: Red-lined draft of Gas Standard 184.0015	299
Attachment G: Red-lined draft of Gas Standard 184.0060	306
Attachment H: Gas Standard 183.0110	323
Attachment I: Gas Standard 183.03	331
Attachment J: Red-lined draft of Gas Standard 223.0145	348
Attachment K: Red-lined draft of Gas Standard 223.0100	359
Attachment L: Red-lined draft of Gas Standard 184.0005	382
Attachment M: California Energy Commission Notice of Proposed Awards	386
Attachment N: RD&D 2017 Annual Report	393
Attachment O: Red-lined draft of Gas Standard 223.0125	493
Attachment P: Pipeline Blowdowns in Transmission and Distribution	515
Attachment Q: Resolution G-3257	525
Attachment R: Public Awareness Plan for SoCalGas and SDG&E	528
Attachment S: Gas Standard 184.09	594

Best Practice 1: Compliance Plan

PART 1: OVERVIEW

a) Best Practice: #1

b) Status: Work pending approval of AL 5211

Written Compliance Plan identifying the policies, programs, procedures, instructions, documents, etc. used to comply with the Final Decision in this Proceeding (R.15-01-008). Exact wording TBD by the company and approved by the CPUC, in consultation with CARB. Compliance Plans shall be signed by company officers certifying their company's compliance. Compliance Plans shall include copies of all policies and procedures related to their Compliance Plans. Compliance Plans shall be filed biennially (i.e. every other year) to evaluate best practices based on progress and effectiveness of Companies' natural gas leakage abatement and minimization of methane emissions.

PART 2: BEST PRACTICE DETAILS

a) Historic work:

SoCalGas has proactively used internal policies and procedures that require operations to take measures to minimize methane emissions during venting. For example, Gas Standard 223.0145, Planning Shutdowns for Transmission and Storage, states: "Plan to minimize gas blown to atmosphere through the use of Distribution facilities to reduce gas pipeline inventory."

SoCalGas became a founding member of The EPA Natural Gas STAR Program in 1993. Through this program, SoCalGas has implemented methane reducing technologies and practices and documented voluntary emission reduction activities. SoCalGas continuously evaluates methane emission reduction opportunities, implements cost-effective methane reduction projects where feasible, and annually reports methane emission reduction actions to the EPA. Total methane savings by SoCalGas through implementation of methane reduction practices between 1993 and 2016 were 2,620,910,000 MCF.

SoCalGas has long recognized the need to voluntarily reduce methane emissions. The company has contributed to the elimination of methane emissions by employing several different best practices, including:

- Directed Inspection & Maintenance (DI&M); A DI&M program concentrates on components that are prone to leak enough methane to make repairs cost-effective. Such components include valve packing, pneumatic controllers and open-ended lines such as vent and drain connections, blowdown lines, pneumatic engine starter motors, and pressure relief valves.¹
- Identify and rehabilitate leaky distribution pipe; Through regular leak surveys, SoCalGas has identified and repaired or replaced pipeline with high leak rates.

¹ "Conduct Directed Inspection and Maintenance at Remote Sites." *EPA.gov*, 2011, www.epa.gov/natural-gas-star-program/conduct-directed-inspection-and-maintenance-remote-sites.

- Replace compressor rod packing systems; Reciprocating compressors in the natural gas industry leak natural gas during normal operation. Areas of high leak frequency include flanges, valves, and fittings located on compressors. The highest volume of gas loss, however, is associated with piston rod packing systems. Packing systems are used to maintain a tight seal around the piston rod, preventing the gas compressed to high pressure in the compressor cylinder from leaking, while allowing the rod to move freely. Compressor rod packing consists of a series of flexible rings that fit around the shaft to create a seal against leakage. Packing rings are held in place by a set of packing cups, normally one for each pair of rings, and kept tight against the shaft by a surrounding spring. A “nose gasket” on the end of the packing case prevents leaks around the packing cups. Leaking gases are vented to the atmosphere through packing vents on the flange. Leakage can be reduced through proper monitoring and a cost-effective schedule for replacing packing rings and piston rods. New ring materials and new designs for packing cases are emerging that should reduce emissions in the future.²
- Reduce system pressure for maintenance blowdowns; Operators of natural gas pipeline systems routinely reduce line pressure and discharge gas from pipeline sections to provide safe working conditions during maintenance and repair activities. Typically, operators block the smallest possible linear section of the pipeline and depressurize it by venting gas to the atmosphere. Using pump-down techniques to lower gas line pressure before performing maintenance and repair activities is an effective way to reduce emissions and yield significant economic savings. Pipeline pump-down techniques involve using in-line compressors either alone or in sequence with portable compressors. Using in-line compressors is almost always justifiable because there are no capital costs, and payback is immediate. The cost-effectiveness of also using a portable compressor to increase gas recovery, however, depends greatly on site-specific factors and operating costs. Regardless of the pump-down technique selected, emission reductions are directly proportional to how much pipeline pressure is reduced before venting occurs. Pipeline pump-down techniques are most economical for larger volume, higher pressure gas lines and work most effectively for planned maintenance activities and cases in which sufficient manifolding exists to connect a portable compressor.³
- Redesign blowdown process in Emergency Shutdown practices; Compressors are used throughout the natural gas industry to move natural gas from production and processing sites to customer distribution systems. Compressors must periodically be taken off-line for maintenance, operational stand-by, or emergency shut down testing, and as a result, methane may be released to the atmosphere from a number of sources. When compressor units are shut down, typically the high pressure gas remaining within the compressors and associated piping between isolation valves is vented to the atmosphere (‘blowdown’) or to a flare. In addition to blowdown emissions, a depressurized system may continue to leak gas from faulty or improperly sealed unit isolation valves. Simple changes in operating practices and in the design of blowdown systems can save money and significantly reduce methane blowdown valve and from reciprocating compressor rod packing, total emissions can be significantly reduced. Four options for reducing emissions when taking compressors off-line include:

² “Reducing Methane Emissions From Rod Packing Systems.” *EPA.gov*, Natural Gas Star Partners, Oct. 2006, www.epa.gov/sites/production/files/2016-06/documents/ll_rodpack.pdf.

³ “Using Pipeline Pump-Down Techniques.” *Environmental Protection Agency*, Natural Gas STAR Partners, Oct. 2006. https://www.epa.gov/sites/production/files/2016-06/documents/ll_pipeline.pdf

- Keeping compressors pressurized when off-line.
- Connecting blowdown vent lines to the fuel gas system and recovering all, or a portion, of the vented gas to the fuel gas system.
- Installing static seals on compressor rod packing.
- Installing ejectors on compressor blowdown vent lines.

Keeping compressors fully pressurized when off-line achieves immediate payback—there are no capital costs and emissions are avoided by reducing the net leakage rate. Routing blowdown vent lines to the fuel gas system or to a lower pressure gas line reduces fuel costs for the compressor or other facility equipment, in addition to avoiding blowdown emissions. Static seals installed on compression rods eliminate gas leaking back through the rod packing while a compressor is shutdown under pressure. An ejector uses the discharge of an adjacent compressor as motive to pump blowdown or leaked gas from a shutdown compressor into the suction of an operating compressor or a fuel gas system. Benefits of these practices include fewer bulk gas releases, lower leak rates, and lower fuel costs, with a payback in most cases of less than a year.⁴

In addition to SoCalGas' work to reduce emissions through the EPA Natural Gas STAR program, corporate policy has historically supported minimizing emissions and protecting environmental resources. Excerpts from the Sempra Corporate Responsibility report make the following references in relation to methane emissions:

- “Not all greenhouse gases have the same impact on the environment. For example, one unit of methane has approximately 25 times the impact of one unit of carbon dioxide.” (page 26)
- “Since the company joined the Natural Gas Star program in 1993, SoCalGas has implemented practices that have resulted in the reduction of more than 800,000 metric tons of CO₂e, the equivalent of removing 169,000 cars from the road for a year. As a result of these efforts, SoCalGas has one of the lowest methane emission rates of natural gas utilities in the U.S.” (page 32)
- “Fugitive emissions (natural gas/methane emissions from leaks or other types of unintended or irregular releases) are our second most significant type of greenhouse gas emissions, behind emissions from stationary combustion. In 2016, fugitive emissions accounted for 94 percent of our methane emissions.” (page 32)⁵
- Additional information on methane emissions can be found in the link below
 - SoCalGas Methane: <https://www.socalgas.com/stay-safe/methane-emissions>

The Sempra Environmental Policy also supports methane emission reduction, and states “Implement environmental practices where possible and economically prudent, including water reuse and

⁴ “Reducing Emissions When Taking Compressors Off-Line.” *Environmental Protection Agency*, Natural Gas STAR Partners, Oct. 2006, www.epa.gov/sites/production/files/2016-06/documents/ll_compressoroffline.pdf.

⁵ “2016 Corporate Responsibility Report.” *Sempra Energy*, 15 June 2017, www.sempra.com/sustainability/2016-corporate-responsibility-report.

conservation, recycling and waste minimization, greenhouse gas and other air emissions reductions, air quality improvements, and the adoption of building and facility standards;”⁶ A copy of the Sempra Environmental Policy is attached.

Several company procedures and gas standards are in place to mitigate methane emissions, as well as regulations from other governing bodies, such as Pipeline and Hazardous Materials Safety Administration (PHMSA) and Division of Oil, Gas, and Geothermal Resources (DOGGR).

Since the final decision of this proceeding, SoCalGas has been working with Subject Matter Experts to develop annual emissions reports as well as identify opportunities to implement the 26 Best Practices within operational practices with the goal of reducing methane emissions.

b) Alternative Proposal to BP or exemption? No

c) Proposed Plan:

The proposed plan encompasses the development of the attached compliance plans to achieve methane emission reductions through the 26 Best Practices. Proposed activities were evaluated for cost-effectiveness and emissions reduction opportunity, where data was available. Milestones were developed to achieve those emission reductions and develop a timeline for implementation. Activities include policy and procedure development, training development and deployment, increased leak surveys, installation of methane sensing technologies, faster leak repair times, capture of blowdown gas, replacement of high-bleed pneumatic devices, expansion of dig-alert programs, back-office IT projects, RD&D projects, and development of tools to support monitoring, record-keeping, and reporting.

d) Overlap with other regulations? What portion of the BP is incremental beyond those regulations?

All requests for cost recovery in this compliance plan are for activities that are incremental to safety and specific to the emission reduction goals of SB 1371. SoCalGas currently has policies and procedures in place to meet environmental regulation implemented by California Air Resources Board, Environmental Protection Agency, Local Air Pollution Control Districts, And Department of Oil, Gas, and Geothermal Resources. Some of these environmental policies overlap with SB 1371 requirements, and that overlap is addressed in the relevant Best Practices.

⁶ “Environmental Policy.” *Sempra Energy*, 1 Dec. 2017, www.sempra.com/sites/default/files/content/files/node-page/file-list/2017/environmental-policy-2017.pdf.

e) What technology is required to implement the Best Practice and why?

Several new technologies are recommended in this Compliance plan, including a new competency based training program, enhanced leak survey technology, state-of-the-art methane sensing technologies, blowdown capture technologies, replacement of high-bleed pneumatic devices, expansion of dig-alert programs, back-office IT projects, RD&D projects, and development of tools to support monitoring, record-keeping, and reporting.

f) Will work require additional personnel and/or contract support? If so, please provide details.

Each Best Practice specifies incremental needs. SoCalGas' goal is to levelize labor needs where possible for continued improvement and to manage a stable workforce. The is to implement Best Practices that provide the highest emissions reductions first, and as those projects are completed, transfer employees onto the next project so work flow is stable and minimal incremental FTEs will be needed.

g) What changes to existing operations are required? How will those changes be implemented?

Several operational changes are proposed in this Compliance Plan, including training development and deployment, increased leak surveys, installation of methane sensing technologies, faster leak repair times, capture of blowdown gas, replacement of high-bleed pneumatic devices, expansion of dig-alert programs, IT projects, RD&D projects, and development of tools to support monitoring, record-keeping, and reporting.

h) What are the new procedures to develop or existing procedures to modify? Please provide details.

New procedures are detailed in the respective Best Practices. Some draft procedural changes are provided as attachments. However, some proposed changes to operational changes will be labor intensive to draft so SoCalGas is choosing to await approval before investing time to develop scenarios that may not come to fruition.

i) Timeline for implementation (Milestones):

SoCalGas will submit the first Biennial Compliance Plan on March 15, 2018. Implementation of the activities for each Best Practice will begin after cost recovery is approved. One exception is some RD&D pilot studies began in January 2018. Early implementation of these RD&D projects was approved, as the results of the pilot studies could influence strategy in this Compliance Plan.

j) Identify the range of factors or considerations used to determine cost-effectiveness of this measure, when costs estimates have been determined:

Cost-effectiveness evaluations were performed for activities where emissions reductions could be measured, specifically Best Practices 15, 16, 20a, 21, 23, and 24. Cost-effectiveness evaluations were generated by calculating the cumulative revenue requirement for activities that directly contribute to

emissions reductions. The activity costs used to calculate the revenue requirement include the fully loaded and escalated capital investment and associated O&M, including on-going O&M over the useful life of the related capital asset, if applicable. The cumulative revenue requirement was divided by the total years of useful life to generate an average annual revenue requirement. Multiplying this annual average revenue requirement by 12 gives the estimated total cost of implementation for the SB 1371 program from 2018 through 2030.

The relevant emissions model was used to estimate emission reductions for each year through 2030. Annual emissions were compounded and summed to generate a total emissions reduction over the twelve year program period.

Cost benefits were evaluated at the forecasted average annual Weighted Average Cost of Gas (WACOG) published in the 2016 California Gas Report, converted to cost per MCF using a BTU conversion factor of 1.0343

Forecasted Average WACOG (\$/MCF)	
Year	Cost/MCF
2018	\$2.86
2019	\$2.66
2020	\$2.65
2021	\$2.99
2022	\$3.48
2023	\$3.74
2024	\$3.95
2025	\$4.22
2026	\$4.53
2027	\$4.62
2028	\$4.73
2029	\$4.94
2030	\$5.14

Cost-effectiveness is generated by dividing the cost of implementation less any cost benefits by estimated emission reduction.

k) Identify any cost benefits from this BP, when cost estimates are known:

Cost benefits are itemized in each Best Practice.

l) Do any incremental costs, if known, or benefits overlap with other BPs? If so, to which BP do they overlap, what are they, and how do they overlap?

N/A.
m) Anticipated Emissions Reductions from this BP: Total estimated emissions reductions resulting from activities proposed in this compliance plan, compounded from 2018 to 2030 that are quantifiable are estimated at 5,103,713 MCF. Expected annual emissions in 2030, based on modeling and assumptions as stated in this Compliance Plan, are 2,340,380 MCF, an estimated 16% reduction. 2015 Baseline Emissions affected, where known: The 2015 baseline for the entire SoCalGas system is 2,779,853 MCF per year
n) Calculation Methodology: Emission reduction calculations vary by emission source, and are specific to each Best Practice.
o) Additional Comments: N/A
p) Overlap with Safety: N/A
SUPPLEMENTAL INFORMATION
a) Technology:
b) Changes to Operations:
c) Research or Studies:
d) Other:

Best Practice 2: Methane GHG Policy

PART 1: OVERVIEW

a) Best Practice: 2

b) Status: Work pending approval of AL 5211

Written company policy stating that methane is a potent Green House Gas (GHG) that must be prevented from escaping to the atmosphere. Include reference to SB 1371 and SB 1383. Exact wording TBD by the company and approved by the CPUC, in consultation with CARB, as part of Compliance Plan filing.

PART 2: BEST PRACTICE DETAILS

a) Historic work:

SoCalGas has proactively used internal policies and procedures that require operations to take measures to minimize methane emissions during venting. For example, Gas Standard 223.0145, Planning Shutdowns for Transmission and Storage, states: "Plan to minimize gas blown to atmosphere through the use of Distribution facilities to reduce gas pipeline inventory."

SoCalGas became a founding member of The EPA Natural Gas STAR Program in 1993. Through this program, SoCalGas has implemented methane reducing technologies and practices and documented voluntary emission reduction activities. SoCalGas continuously evaluates methane emission reduction opportunities, implements cost-effective methane reduction projects where feasible, and annually reports methane emission reduction actions to the EPA. Total methane savings by SoCalGas through implementation of methane reduction practices between 1993 and 2016 were 2,620,910,000 MCF.

SoCalGas has long recognized the need to voluntarily reduce methane emissions. The company has contributed to the elimination of methane emissions by employing several different Best Practices, including:

- Directed Inspection & Maintenance (DI&M); A DI&M program concentrates on components that are prone to leak enough methane to make repairs cost-effective. Such components include valve packing, pneumatic controllers and open-ended lines such as vent and drain connections, blowdown lines, pneumatic engine starter motors, and pressure relief valves.⁷
- Identify and rehabilitate leaky distribution pipe; Through regular leak surveys, SoCalGas has identified and repaired or replaced pipeline with high leak rates.
- Replace compressor rod packing systems; Reciprocating compressors in the natural gas industry leak natural gas during normal operation. Areas of high leak frequency include flanges, valves, and fittings located on compressors. The highest volume of gas loss, however, is associated with piston rod packing systems. Packing systems are used to maintain a tight

⁷ "Conduct Directed Inspection and Maintenance at Remote Sites." *EPA.gov*, 2011, www.epa.gov/natural-gas-star-program/conduct-directed-inspection-and-maintenance-remote-sites.

seal around the piston rod, preventing the gas compressed to high pressure in the compressor cylinder from leaking, while allowing the rod to move freely. Compressor rod packing consists of a series of flexible rings that fit around the shaft to create a seal against leakage. Packing rings are held in place by a set of packing cups, normally one for each pair of the smallest possible linear section of the pipeline and depressurize it by venting gas to the atmosphere. In 2004, an estimated 12 billion cubic feet (BCF) of methane was vented to the atmosphere during routine maintenance and pipeline upsets. Using pump-down techniques to lower gas line pressure before performing maintenance and repair activities is an effective way to reduce emissions and yield significant economic savings. Pipeline pump-down techniques involve using in-line compressors either alone or in sequence with portable compressors. Using in-line compressors is almost always justifiable because there are no capital costs, and payback is immediate. The cost-effectiveness of also using a portable compressor to increase gas recovery, however, depends greatly on site-specific factors and operating costs. Regardless of the pump-down technique selected, emission reductions are directly proportional to how much pipeline pressure is reduced before venting occurs. On average, up to 90 percent of the gas in the pipeline can be recovered for sale instead of being emitted. Pipeline pump-down techniques are most economical for larger volume, higher pressure gas lines and work most effectively for planned maintenance activities and cases in which sufficient manifolding exists to connect a portable compressor.⁸

- Redesign blowdown process in Emergency Shutdown practices; Compressors are used throughout the natural gas industry to move natural gas from production and processing sites to customer distribution systems. Compressors must periodically be taken off-line for maintenance, operational stand-by, or emergency shut down testing, and as a result, methane may be released to the atmosphere from a number of sources. When compressor units are shut down, typically the high pressure gas remaining within the compressors and associated piping between isolation valves is vented to the atmosphere ('blowdown') or to a flare. In addition to blowdown emissions, a depressurized system may continue to leak gas from faulty or improperly sealed unit isolation valves. Simple changes in operating practices and in the design of blowdown systems can save money and significantly reduce methane blowdown valve and from reciprocating compressor rod packing, total emissions can be significantly reduced. Four options for reducing emissions when taking compressors off-line include:
 - Keeping compressors pressurized when off-line.
 - Connecting blowdown vent lines to the fuel gas system and recovering all, or a portion, of the vented gas to the fuel gas system.
 - Installing static seals on compressor rod packing.
 - Installing ejectors on compressor blowdown vent lines.

Keeping compressors fully pressurized when off-line achieves immediate payback—there are no capital costs and emissions are avoided by reducing the net leakage rate. Routing blowdown vent lines to the fuel gas system or to a lower pressure gas line reduces fuel costs for the compressor or other facility equipment, in addition to avoiding blowdown emissions. Static seals installed on compression rods eliminate gas leaking back through the rod packing while a compressor is shutdown under pressure. An ejector uses the discharge of an adjacent compressor as motive to pump blowdown or leaked gas from a shutdown compressor into the

⁸ "Using Pipeline Pump-Down Techniques." *Environmental Protection Agency*, Natural Gas STAR Partners, Oct. 2006. https://www.epa.gov/sites/production/files/2016-06/documents/II_pipeline.pdf

suction of an operating compressor or a fuel gas system. Benefits of these practices include fewer bulk gas releases, lower leak rates, and lower fuel costs, with a payback in most cases of less than a year.⁹

In addition to SoCalGas' work to reduce emissions through the EPA Natural Gas STAR program, corporate policy has historically supported minimizing emissions and protecting environmental resources. Excerpts from the Sempra Corporate Responsibility report make the following references in relation to methane emissions:

- "Not all greenhouse gases have the same impact on the environment. For example, one unit of methane has approximately 25 times the impact of one unit of carbon dioxide." (page 26)
- "Since the company joined the Natural Gas Star program in 1993, SoCalGas has implemented practices that have resulted in the reduction of more than 800,000 metric tons of CO₂e, the equivalent of removing 169,000 cars from the road for a year. As a result of these efforts, SoCalGas has one of the lowest methane emission rates of natural gas utilities in the U.S." (page 32)
- "Fugitive emissions (natural gas/methane emissions from leaks or other types of unintended or irregular releases) are our second most significant type of greenhouse gas emissions, behind emissions from stationary combustion. In 2016, fugitive emissions accounted for 94 percent of our methane emissions." (page 32)¹⁰
- Additional information on methane emissions can be found in the link below
 - SoCalGas Methane: <https://www.socalgas.com/stay-safe/methane-emissions>

The Sempra Environmental Policy also supports methane emission reduction, and states "Implement environmental practices where possible and economically prudent, including water reuse and conservation, recycling and waste minimization, greenhouse gas and other air emissions reductions, air quality improvements, and the adoption of building and facility standards;"¹¹ A copy of the Sempra Environmental Policy is attached.

Several company procedures and gas standards are in place to mitigate methane emissions, as well as regulations from other governing bodies, such as Pipeline and Hazardous Materials Safety Administration (PHMSA) and Division of Oil, Gas, and Geothermal Resources (DOGGR).

⁹ "Reducing Emissions When Taking Compressors Off-Line." *Environmental Protection Agency*, Natural Gas STAR Partners, Oct. 2006, www.epa.gov/sites/production/files/2016-06/documents/ll_compressoroffline.pdf.

¹⁰ "2016 Corporate Responsibility Report." *Sempra Energy*, 15 June 2017, www.sempra.com/sustainability/2016-corporate-responsibility-report.

¹¹ "Environmental Policy." *Sempra Energy*, 1 Dec. 2017, www.sempra.com/sites/default/files/content/files/node-page/file-list/2017/environmental-policy-2017.pdf.

b) Alternative Proposal to BP or exemption? No

c) Proposed Plan:

The existing SoCalGas Environmental Excellence Policy has been red-lined to reflect that methane is a potent greenhouse gas and that reducing methane emissions is a priority for SoCalGas. These are draft edits, and final language will be developed upon review and approval by the CPUC.

d) Overlap with other regulations? What portion of the BP is incremental beyond those regulations?

The company is subject to other regulations that require specific practices to reduce, mitigate or control the release of methane emissions. All company operations follow the U.S. Department of Transportation Pipeline and Hazardous Materials Safety Administration (PHMSA) regulations for infrastructure monitoring and testing.

No existing policy explicitly states, “methane is a potent Green House Gas (GHG) that must be prevented from escaping to the atmosphere”. In that respect, this Best Practice will require updating the SoCalGas Environmental Excellence policy to reflect that language, which is incremental beyond other existing regulations.

e) What technology is required to implement the Best Practice and why?

N/A

f) Will work require additional personnel and/or contract support? If so, please provide details.

No incremental personnel are needed for this activity.

g) What changes to existing operations are required? How will those changes be implemented?

No operational changes are required as part of this Best Practice.

h) What are the new procedures to develop or existing procedures to modify? Please provide details.

No procedural changes are required as part of this Best Practice.

i) Timeline for implementation (Milestones):

If the language in the attached draft red-lined SoCalGas Environmental Excellence Policy is approved by the CPUC as meeting the requirements of this Best Practice, the updated language will be made published within one month of approval of this Compliance Plan. If changes are requested, it may take up to three months after approval to finalize new language in the policy.

j) Identify the range of factors or considerations used to determine cost-effectiveness of this measure, when costs estimates have been determined:

There is insufficient data to calculate emission reductions for activities in this Best Practice.

k) Identify any cost benefits from this BP, when cost estimates are known:

There isn't sufficient data to estimate cost benefits associated with the activities in this Best Practice.

l) Do any incremental costs, if known, or benefits overlap with other BPs? If so, to which BP do they overlap, what are they, and how do they overlap?

N/A

m) Anticipated Emissions Reductions from this BP:

There is insufficient data to calculate emission reductions for activities in this Best Practice.

2015 Baseline Emissions affected, where known:

N/A

n) Calculation Methodology:

N/A

o) Additional Comments:

N/A

p) Overlap with Safety:

N/A

SUPPLEMENTAL INFORMATION

a) Technology

b) Changes to Operations:

c) Research or Studies:

d) Other:

Attachment A: Red-lined Environmental Excellence Policy

Attachment B: Sempra Environmental Policy

Attachment C: Sempra Corporate Responsibility Report

Best Practice 3: Pressure Reduction Policy

2018 LEAK ABATEMENT COMPLIANCE PLAN TEMPLATE (D.17-06-015)

PART 1: OVERVIEW	
a) Best Practice: #3	b) Status: Work pending approval of AL 5211
<p>Written company policy stating that pressure reduction to the lowest operationally feasible level in order to minimize methane emissions is required before non-emergency venting of high-pressure distribution (above 60 psig), transmission and underground storage infrastructure consistent with safe operations and considering alternative potential sources of supply to reliably serve customers. Exact wording TBD by the company and approved by the CPUC, in consultation with CARB, as part of Compliance Plan filing.</p>	
PART 2: BEST PRACTICE DETAILS	
a) Historic work:	
<p>SoCalGas has proactively used internal policies and procedures that require operations to take measures to minimize methane emissions during venting. For example, Gas Standard 223.0145, Planning Shutdowns for Transmission and Storage, states: "Plan to minimize gas blown to atmosphere through the use of Distribution facilities to reduce gas pipeline inventory."</p>	
<p>SoCalGas became a founding member of The EPA Natural Gas STAR Program in 1993. Through this program, SoCalGas has implemented methane reducing technologies and practices and documented voluntary emission reduction activities. SoCalGas continuously evaluates methane emission reduction opportunities, implements cost-effective methane reduction projects where feasible, and annually reports methane emission reduction actions to the EPA. Total methane savings by SoCalGas through implementation of methane reduction practices between 1993 and 2016 were 2,620,910,000 cubic feet.</p>	
<p>SoCalGas has long recognized the need to voluntarily reduce methane emissions. The company has contributed to the elimination of methane emissions by employing several different best practices, including:</p>	
<ul style="list-style-type: none">• <u>Directed Inspection & Maintenance (DI&M)</u>; A DI&M program concentrates on components that are prone to leak enough methane to make repairs cost-effective. Such components include valve packing, pneumatic controllers and open-ended lines such as vent and drain connections, blowdown lines, pneumatic engine starter motors, and pressure relief valves.¹²	

¹² "Conduct Directed Inspection and Maintenance at Remote Sites." *EPA.gov*, 2011, www.epa.gov/natural-gas-star-program/conduct-directed-inspection-and-maintenance-remote-sites.

- Identify and rehabilitate leaky distribution pipe; Through regular leak surveys, SoCalGas has identified and repaired or replaced pipeline that with high leak rates.
- Replace compressor rod packing systems; Reciprocating compressors in the natural gas industry leak natural gas during normal operation. Areas of high leak frequency include flanges, valves, and fittings located on compressors. The highest volume of gas loss, however, is associated with piston rod packing systems. Packing systems are used to maintain a tight seal around the piston rod, preventing the gas compressed to high pressure in the compressor cylinder from leaking, while allowing the rod to move freely. Compressor rod packing consists of a series of flexible rings that fit around the shaft to create a seal against leakage. Packing rings are held in place by a set of packing cups, normally one for each pair of rings, and kept tight against the shaft by a surrounding spring. A “nose gasket” on the end of the packing case prevents leaks around the packing cups. Leaking gases are vented to the atmosphere through packing vents on the flange. Leakage can be reduced through proper monitoring and a cost-effective schedule for replacing packing rings and piston rods. New ring materials and new designs for packing cases are emerging that should reduce emissions in the future.¹³
- Reduce system pressure for maintenance blowdowns; Operators of natural gas pipeline systems routinely reduce line pressure and discharge gas from pipeline sections to provide safe working conditions during maintenance and repair activities. Typically, operators block the smallest possible linear section of the pipeline and depressurize it by venting gas to the atmosphere. Using pump-down techniques to lower gas line pressure before performing maintenance and repair activities is an effective way to reduce emissions and yield significant economic savings. Pipeline pump-down techniques involve using in-line compressors either alone or in sequence with portable compressors. Using in-line compressors is almost always justifiable because there are no capital costs, and payback is immediate. The cost-effectiveness of also using a portable compressor to increase gas recovery, however, depends greatly on site-specific factors and operating costs. Regardless of the pump-down technique selected, emission reductions are directly proportional to how much pipeline pressure is reduced before venting occurs. Pipeline pump-down techniques are most economical for larger volume, higher pressure gas lines and work most effectively for planned maintenance activities and cases in which sufficient manifolding exists to connect a portable compressor.¹⁴
- Redesign blowdown process in Emergency Shutdown practices; Compressors are used throughout the natural gas industry to move natural gas from production and processing sites to customer distribution systems. Compressors must periodically be taken off-line for maintenance, operational stand-by, or emergency shut down testing, and as a result, methane may be released to the atmosphere from a number of sources. When compressor units are shut down, typically the high pressure gas remaining within the compressors and associated piping between isolation valves is vented to the atmosphere (“blowdown”) or to a flare. In addition to blowdown emissions, a depressurized system may continue to leak gas from faulty or improperly sealed unit isolation valves. Simple changes in operating practices and in the design of blowdown systems can save money and significantly reduce methane blowdown valve and from reciprocating compressor rod packing, total emissions can be

¹³ “Reducing Methane Emissions From Rod Packing Systems.” *EPA.gov*, Natural Gas Star Partners, Oct. 2006, www.epa.gov/sites/production/files/2016-06/documents/ll_rodpack.pdf.

¹⁴ “Using Pipeline Pump-Down Techniques.” *Environmental Protection Agency*, Natural Gas STAR Partners, Oct. 2006. https://www.epa.gov/sites/production/files/2016-06/documents/ll_pipeline.pdf

significantly reduced. Four options for reducing emissions when taking compressors off-line include:

- Keeping compressors pressurized when off-line.
- Connecting blowdown vent lines to the fuel gas system and recovering all, or a portion, of the vented gas to the fuel gas system.
- Installing static seals on compressor rod packing.
- Installing ejectors on compressor blowdown vent lines.

Keeping compressors fully pressurized when off-line achieves immediate payback—there are no capital costs and emissions are avoided by reducing the net leakage rate. Routing blowdown vent lines to the fuel gas system or to a lower pressure gas line reduces fuel costs for the compressor or other facility equipment, in addition to avoiding blowdown emissions. Static seals installed on compression rods eliminate gas leaking back through the rod packing while a compressor is shutdown under pressure. An ejector uses the discharge of an adjacent compressor as motive to pump blowdown or leaked gas from a shutdown compressor into the suction of an operating compressor or a fuel gas system. Benefits of these practices include fewer bulk gas releases, lower leak rates, and lower fuel costs, with a payback in most cases of less than a year.¹⁵

In addition to SoCalGas' work to reduce emissions through the EPA Natural Gas STAR program, corporate policy has historically supported minimizing emissions and protecting environmental resources. Excerpts from the Sempra Corporate Responsibility report make the following references in relation to methane emissions:

- “Not all greenhouse gases have the same impact on the environment. For example, one unit of methane has approximately 25 times the impact of one unit of carbon dioxide.” (page 26)
- “Since the company joined the Natural Gas Star program in 1993, SoCalGas has implemented practices that have resulted in the reduction of more than 800,000 metric tons of CO₂e, the equivalent of removing 169,000 cars from the road for a year. As a result of these efforts, SoCalGas has one of the lowest methane emission rates of natural gas utilities in the U.S.” (page 32)
- “Fugitive emissions (natural gas/methane emissions from leaks or other types of unintended or irregular releases) are our second most significant type of greenhouse gas emissions, behind emissions from stationary combustion. In 2016, fugitive emissions accounted for 94 percent of our methane emissions.” (page 32)¹⁶
- Additional information on methane emissions can be found in the link below

¹⁵ “Reducing Emissions When Taking Compressors Off-Line.” *Environmental Protection Agency*, Natural Gas STAR Partners, Oct. 2006, www.epa.gov/sites/production/files/2016-06/documents/II_compressoroffline.pdf.

¹⁶ “2016 Corporate Responsibility Report.” *Sempra Energy*, 15 June 2017, www.sempra.com/sustainability/2016-corporate-responsibility-report.

- SoCalGas Methane: <https://www.socalgas.com/stay-safe/methane-emissions>

The Sempra Environmental Policy also supports methane emission reduction, and states “Implement environmental practices where possible and economically prudent, including water reuse and conservation, recycling and waste minimization, greenhouse gas and other air emissions reductions, air quality improvements, and the adoption of building and facility standards;”¹⁷ A copy of the Sempra Environmental Policy is attached.

Several company procedures and gas standards are in place to mitigate methane emissions, as well as regulations from other governing bodies, such as Pipeline and Hazardous Materials Safety Administration (PHMSA) and Division of Oil, Gas, and Geothermal Resources (DOGGR).

b) Alternative Proposal to BP or exemption? No

c) Proposed Plan:

SoCalGas is updating Gas Standards 184.06 and 182.0160 to clarify policy and procedural changes to minimize methane emissions. Red-lined gas standards are attached.

d) Overlap with other regulations? What portion of the BP is incremental beyond those regulations?

SoCalGas is subject to other regulations that require specific practices to reduce, mitigate or control the release of methane emissions. All company operations follow the U.S. Department of Transportation Pipeline and Hazardous Materials Safety Administration (PHMSA) regulations for infrastructure monitoring and testing.

e) What technology is required to implement the best practice and why?

There are no technology needs to change the policy.

f) Will work require additional personnel and/or contract support? If so, please provide details.

No additional personnel is need to complete the activities in this Best Practice, this work fits within the scope of normal business activities.

g) What changes to existing operations are required? How will those changes be implemented?

No operational changes are required as part of this Best Practice.

¹⁷ “Environmental Policy.” *Sempra Energy*, 1 Dec. 2017, www.sempra.com/sites/default/files/content/files/node-page/file-list/2017/environmental-policy-2017.pdf.

h) What are the new procedures to develop or existing procedures to modify? Please provide details.

SoCalGas is updating Gas Standards 184.06 and 182.0160 to clarify procedural changes to minimize methane emissions. Red-lined gas standards are attached.

i) Timeline for implementation (Milestones):

All milestones are listed as the approximate length of time to completion from the date cost recovery is approved.

- Policy review: 2 months
- Training development: 3-6 months
- Training of field department: 6-12 months
- Publishing policy changes: 12 months
- Field implementation completion: 12 months

j) Identify the range of factors or considerations used to determine cost-effectiveness of this measure, when costs estimates have been determined:

There is insufficient data to estimate emission reductions as a result of the activities in this Best Practice.

k) Identify any cost benefits from this BP, when cost estimates are known:

There is insufficient data to estimate cost benefits associated with the activities in this Best Practice.

l) Do any incremental costs, if known, or benefits overlap with other BPs? If so, to which BP do they overlap, what are they, and how do they overlap?

Training needs addressed in best practices 3, 4, 5, 6, 7, and 23 will be affected by policy changes in this best practice.

m) Anticipated Emissions Reductions from this BP:

There is insufficient data to estimate emission reductions as a result of the activities in this Best Practice.

2015 Baseline Emissions affected, where known:

N/A

n) Calculation Methodology:

N/A

o) Additional Comments:

N/A
p) Overlap with Safety: N/A
SUPPLEMENTAL INFORMATION
a) Technology:
b) Changes to Operations: The accompanying attachments have been redacted to remove non-responsive, non-relevant employee information. Attachment D: Red-lined draft of Gas Standard 184.06 Attachment E: Red-lined draft of Gas Standard 182.0160
c) Research or Studies:
d) Other:

Best Practice 4: Project Scheduling Policy

2018 LEAK ABATEMENT COMPLIANCE PLAN TEMPLATE (D.17-06-015)

PART 1: OVERVIEW	
a) Best Practice: #4	b) Status: Work pending approval of AL 5211
<p>Written company policy stating that any high pressure distribution (above 60 psig), transmission or underground storage infrastructure project that requires evacuating methane will build time into the project schedule to minimize methane emissions to the atmosphere consistent with safe operations and considering alternative potential sources of supply to reliably serve customers. Projected schedules of high pressure distribution (above 60 psig), transmission or underground storage infrastructure work, requiring methane evacuation, shall also be submitted to facilitate audits, with line venting schedule updates TBD. Exact wording TBD by the company and approved by the CPUC, in consultation with CARB, as part of the Compliance Plan filing.</p>	
PART 2: BEST PRACTICE DETAILS	
a) Historic work:	
<p>SoCalGas has proactively used internal policies and procedures that require operations to take measures to minimize methane emissions during venting. For example, Gas Standard 223.0145, Planning Shutdowns for Transmission and Storage, states: "Plan to minimize gas blown to atmosphere through the use of Distribution facilities to reduce gas pipeline inventory."</p>	
<p>SoCalGas became a founding member of The EPA Natural Gas STAR Program in 1993. Through this program, SoCalGas has implemented methane reducing technologies and practices and documented voluntary emission reduction activities. SoCalGas continuously evaluates methane emission reduction opportunities, implements cost-effective methane reduction projects where feasible, and annually reports methane emission reduction actions to the EPA. Total methane savings by SoCalGas through implementation of methane reduction practices between 1993 and 2016 were 2,620,910,000 cubic feet.</p>	
<p>SoCalGas has long recognized the need to voluntarily reduce methane emissions. The company has contributed to the elimination of methane emissions by employing several different best practices, including:</p>	
<ul style="list-style-type: none">• <u>Directed Inspection & Maintenance (DI&M)</u>; A DI&M program concentrates on components that are prone to leak enough methane to make repairs cost-effective. Such components	

include valve packing, pneumatic controllers and open-ended lines such as vent and drain connections, blowdown lines, pneumatic engine starter motors, and pressure relief valves.¹⁸

- Identify and rehabilitate leaky distribution pipe; Through regular leak surveys, SoCalGas has identified and repaired or replaced pipeline that with high leak rates.
- Replace compressor rod packing systems; Reciprocating compressors in the natural gas industry leak natural gas during normal operation. Areas of high leak frequency include flanges, valves, and fittings located on compressors. The highest volume of gas loss, however, is associated with piston rod packing systems. Packing systems are used to maintain a tight seal around the piston rod, preventing the gas compressed to high pressure in the compressor cylinder from leaking, while allowing the rod to move freely. Compressor rod packing consists of a series of flexible rings that fit around the shaft to create a seal against leakage. Packing rings are held in place by a set of packing cups, normally one for each pair of rings, and kept tight against the shaft by a surrounding spring. A “nose gasket” on the end of the packing case prevents leaks around the packing cups. Leaking gases are vented to the atmosphere through packing vents on the flange. Leakage can be reduced through proper monitoring and a cost-effective schedule for replacing packing rings and piston rods. New ring materials and new designs for packing cases are emerging that should reduce emissions in the future.¹⁹
- Reduce system pressure for maintenance blowdowns; Operators of natural gas pipeline systems routinely reduce line pressure and discharge gas from pipeline sections to provide safe working conditions during maintenance and repair activities. Typically, operators block the smallest possible linear section of the pipeline and depressurize it by venting gas to the atmosphere. Using pump-down techniques to lower gas line pressure before performing maintenance and repair activities is an effective way to reduce emissions and yield significant economic savings. Pipeline pump-down techniques involve using in-line compressors either alone or in sequence with portable compressors. Using in-line compressors is almost always justifiable because there are no capital costs, and payback is immediate. The cost-effectiveness of also using a portable compressor to increase gas recovery, however, depends greatly on site-specific factors and operating costs. Regardless of the pump-down technique selected, emission reductions are directly proportional to how much pipeline pressure is reduced before venting occurs. Pipeline pump-down techniques are most economical for larger volume, higher pressure gas lines and work most effectively for planned maintenance activities and cases in which sufficient manifolding exists to connect a portable compressor.²⁰
- Redesign blowdown process in Emergency Shutdown practices; Compressors are used throughout the natural gas industry to move natural gas from production and processing sites to customer distribution systems. Compressors must periodically be taken off-line for maintenance, operational stand-by, or emergency shut down testing, and as a result, methane may be released to the atmosphere from a number of sources. When compressor units are shut down, typically the high pressure gas remaining within the compressors and associated piping between isolation valves is vented to the atmosphere (‘blowdown’) or to a

¹⁸ “Conduct Directed Inspection and Maintenance at Remote Sites.” *EPA.gov*, 2011, www.epa.gov/natural-gas-star-program/conduct-directed-inspection-and-maintenance-remote-sites.

¹⁹ “Reducing Methane Emissions From Rod Packing Systems.” *EPA.gov*, Natural Gas Star Partners, Oct. 2006, www.epa.gov/sites/production/files/2016-06/documents/ll_rodpack.pdf.

²⁰ “Using Pipeline Pump-Down Techniques.” *Environmental Protection Agency*, Natural Gas STAR Partners, Oct. 2006. https://www.epa.gov/sites/production/files/2016-06/documents/ll_pipeline.pdf

flare. In addition to blowdown emissions, a depressurized system may continue to leak gas from faulty or improperly sealed unit isolation valves. Simple changes in operating practices and in the design of blowdown systems can save money and significantly reduce methane blowdown valve and from reciprocating compressor rod packing, total emissions can be significantly reduced. Four options for reducing emissions when taking compressors off-line include:

- Keeping compressors pressurized when off-line.
- Connecting blowdown vent lines to the fuel gas system and recovering all, or a portion, of the vented gas to the fuel gas system.
- Installing static seals on compressor rod packing.
- Installing ejectors on compressor blowdown vent lines.

Keeping compressors fully pressurized when off-line achieves immediate payback—there are no capital costs and emissions are avoided by reducing the net leakage rate. Routing blowdown vent lines to the fuel gas system or to a lower pressure gas line reduces fuel costs for the compressor or other facility equipment, in addition to avoiding blowdown emissions. Static seals installed on compression rods eliminate gas leaking back through the rod packing while a compressor is shutdown under pressure. An ejector uses the discharge of an adjacent compressor as motive to pump blowdown or leaked gas from a shut down compressor into the suction of an operating compressor or a fuel gas system. Benefits of these practices include fewer bulk gas releases, lower leak rates, and lower fuel costs, with a payback in most cases of less than a year.²¹

In addition to SoCalGas' work to reduce emissions through the EPA Natural Gas STAR program, corporate policy has historically supported minimizing emissions and protecting environmental resources. Excerpts from the Sempra Corporate Responsibility report make the following references in relation to methane emissions:

- “Not all greenhouse gases have the same impact on the environment. For example, one unit of methane has approximately 25 times the impact of one unit of carbon dioxide.” (page 26)
- “Since the company joined the Natural Gas Star program in 1993, SoCalGas has implemented practices that have resulted in the reduction of more than 800,000 metric tons of CO₂e, the equivalent of removing 169,000 cars from the road for a year. As a result of these efforts, SoCalGas has one of the lowest methane emission rates of natural gas utilities in the U.S.”(page 32)
- “Fugitive emissions (natural gas/methane emissions from leaks or other types of unintended or irregular releases) are our second most significant type of greenhouse gas emissions,

²¹ “Reducing Emissions When Taking Compressors Off-Line.” *Environmental Protection Agency, Natural Gas STAR Partners*, Oct. 2006, www.epa.gov/sites/production/files/2016-06/documents/ll_compressoroffline.pdf.

behind emissions from stationary combustion. In 2016, fugitive emissions accounted for 94 percent of our methane emissions.” (page 32)²²

- Additional information on methane emissions can be found in the link below
 - SoCalGas Methane: <https://www.socalgas.com/stay-safe/methane-emissions>

The Sempra Environmental Policy also supports methane emission reduction, and states “Implement environmental practices where possible and economically prudent, including water reuse and conservation, recycling and waste minimization, greenhouse gas and other air emissions reductions, air quality improvements, and the adoption of building and facility standards;”²³ A copy of the Sempra Environmental Policy is attached.

Several company procedures and gas standards are in place to mitigate methane emissions, as well as regulations from other governing bodies, such as Pipeline and Hazardous Materials Safety Administration (PHMSA) and Division of Oil, Gas, and Geothermal Resources (DOGGR).

b) Alternative Proposal to BP or exemption? No

c) Proposed Plan:

SoCalGas is updating Gas Standards 184.06 and 182.0160 to clarify procedural changes to minimize methane emissions. Red-lined gas standards are attached.

d) Overlap with other regulations? What portion of the BP is incremental beyond those regulations?

SoCalGas is subject to other regulations that require specific practices to reduce, mitigate or control the release of methane emissions. All company operations follow the U.S. Department of Transportation Pipeline and Hazardous Materials Safety Administration (PHMSA) regulations for infrastructure monitoring and testing.

e) What technology is required to implement the best practice and why?

There are no technology needs to change the policy.

f) Will work require additional personnel and/or contract support? If so, please provide details.

No additional personnel is need to complete the activities in this Best Practice, this work fits within the scope of normal business activities.

g) What changes to existing operations are required? How will those changes be implemented?

²² “2016 Corporate Responsibility Report.” *Sempra Energy*, 15 June 2017, www.sempra.com/sustainability/2016-corporate-responsibility-report.

²³ “Environmental Policy.” *Sempra Energy*, 1 Dec. 2017, www.sempra.com/sites/default/files/content/files/node-page/file-list/2017/environmental-policy-2017.pdf.

In Best Practice 23 a centralized engineering group to coordinate methane emission minimization from operations is proposed. They would be responsible for coordinating cross-departmental efforts to build in time for methane evacuation.

h) What are the new procedures to develop or existing procedures to modify? Please provide details.

SoCalGas is updating Gas Standards 184.06 and 182.0160 to clarify procedural changes to minimize methane emissions. Red-lined gas standards are attached. Detailed project management will be developed based on these policy changes so compliance is met.

i) Timeline for implementation (Milestones):

All milestones are listed as the approximate length of time to completion from the date cost recovery is approved:

- Policy review: 2 months
- Training development: 3-6 months
- Training of field department: 6-12 months
- Publishing policy changes: 12 months
- Field implementation completion: 12 months

j) Identify the range of factors or considerations used to determine cost-effectiveness of this measure, when costs estimates have been determined:

There is insufficient data to estimate emission reductions from the activities in this Best Practice and therefore.

k) Identify any cost benefits from this BP, when cost estimates are known:

There is insufficient data to estimate cost benefits associated with the activities in this Best Practice.

l) Do any incremental costs, if known, or benefits overlap with other BPs? If so, to which BP do they overlap, what are they, and how do they overlap?

Training needs addressed in best practices 3, 4, 5, 6, 7, and 23 will be affected by policy changes in this best practice.

m) Anticipated Emissions Reductions from this BP:

There is insufficient data to estimate emission reductions from the activities in this Best Practice and therefore.

2015 Baseline Emissions affected, where known:

N/A

n) Calculation Methodology: N/A
o) Additional Comments: N/A
p) Overlap with Safety: N/A
SUPPLEMENTAL INFORMATION
a) Technology:
b) Changes to Operations: The accompanying attachments have been redacted to remove non-responsive, non-relevant employee information. Attachment D: Red-lined draft of Gas Standard 184.06 Attachment E: Red-lined draft of Gas Standard 182.0160
c) Research or Studies:
d) Other:

Best Practice 5: Methane Evacuation Procedures

2018 LEAK ABATEMENT COMPLIANCE PLAN TEMPLATE (D.17-06-015)

PART 1: OVERVIEW	
a) Best Practice: #5	b) Status: Work pending approval of AL 5211
Written company procedures implementing the BPs approved for use to evacuate methane for non-emergency venting of high pressure distribution (above 60 psig), transmission or underground storage infrastructure and how to use them consistent with safe operations and considering alternative potential sources of supply to reliably serve customers. Exact wording TBD by the company and approved by the CPUC, in consultation with CARB, as part of the Compliance Plan filing.	
PART 2: BEST PRACTICE DETAILS	
a) Historic work:	
<p>SoCalGas has proactively used internal policies and procedures that require operations to take measures to minimize methane emissions during venting. For example, Gas Standard 223.0145, Planning Shutdowns for Transmission and Storage, states: “Plan to minimize gas blown to atmosphere through the use of Distribution facilities to reduce gas pipeline inventory.”</p> <p>SoCalGas became a founding member of The EPA Natural Gas STAR Program in 1993. Through this program, SoCalGas has implemented methane reducing technologies and practices and documented voluntary emission reduction activities. SoCalGas continuously evaluates methane emission reduction opportunities, implements cost-effective methane reduction projects where feasible, and annually reports methane emission reduction actions to the EPA. Total methane savings by SoCalGas through implementation of methane reduction practices between 1993 and 2016 were 2,620,910,000 cubic feet.</p> <p>SoCalGas has long recognized the need to voluntarily reduce methane emissions. The company has contributed to the elimination of methane emissions by employing several different best practices, including:</p> <ul style="list-style-type: none">• <u>Directed Inspection & Maintenance (DI&M)</u>; A DI&M program concentrates on components that are prone to leak enough methane to make repairs cost-effective. Such components include valve packing, pneumatic controllers and open-ended lines such as vent and drain connections, blowdown lines, pneumatic engine starter motors, and pressure relief valves.²⁴	

²⁴ “Conduct Directed Inspection and Maintenance at Remote Sites.” *EPA.gov*, 2011, www.epa.gov/natural-gas-star-program/conduct-directed-inspection-and-maintenance-remote-sites.

- Identify and rehabilitate leaky distribution pipe; Through regular leak surveys, SoCalGas has identified and repaired or replaced pipeline that with high leak rates.
- Replace compressor rod packing systems; Reciprocating compressors in the natural gas industry leak natural gas during normal operation. Areas of high leak frequency include flanges, valves, and fittings located on compressors. The highest volume of gas loss, however, is associated with piston rod packing systems. Packing systems are used to maintain a tight seal around the piston rod, preventing the gas compressed to high pressure in the compressor cylinder from leaking, while allowing the rod to move freely. Compressor rod packing consists of a series of flexible rings that fit around the shaft to create a seal against leakage. Packing rings are held in place by a set of packing cups, normally one for each pair of rings, and kept tight against the shaft by a surrounding spring. A “nose gasket” on the end of the packing case prevents leaks around the packing cups. Leaking gases are vented to the atmosphere through packing vents on the flange. Leakage can be reduced through proper monitoring and a cost-effective schedule for replacing packing rings and piston rods. New ring materials and new designs for packing cases are emerging that should reduce emissions in the future.²⁵
- Reduce system pressure for maintenance blowdowns; Operators of natural gas pipeline systems routinely reduce line pressure and discharge gas from pipeline sections to provide safe working conditions during maintenance and repair activities. Typically, operators block the smallest possible linear section of the pipeline and depressurize it by venting gas to the atmosphere. Using pump-down techniques to lower gas line pressure before performing maintenance and repair activities is an effective way to reduce emissions and yield significant economic savings. Pipeline pump-down techniques involve using in-line compressors either alone or in sequence with portable compressors. Using in-line compressors is almost always justifiable because there are no capital costs, and payback is immediate. The cost-effectiveness of also using a portable compressor to increase gas recovery, however, depends greatly on site-specific factors and operating costs. Regardless of the pump-down technique selected, emission reductions are directly proportional to how much pipeline pressure is reduced before venting occurs. Pipeline pump-down techniques are most economical for larger volume, higher pressure gas lines and work most effectively for planned maintenance activities and cases in which sufficient manifolding exists to connect a portable compressor.²⁶
- Redesign blowdown process in Emergency Shutdown practices; Compressors are used throughout the natural gas industry to move natural gas from production and processing sites to customer distribution systems. Compressors must periodically be taken off-line for maintenance, operational stand-by, or emergency shut down testing, and as a result, methane may be released to the atmosphere from a number of sources. When compressor units are shut down, typically the high pressure gas remaining within the compressors and associated piping between isolation valves is vented to the atmosphere (“blowdown”) or to a flare. In addition to blowdown emissions, a depressurized system may continue to leak gas from faulty or improperly sealed unit isolation valves. Simple changes in operating practices and in the design of blowdown systems can save money and significantly reduce methane blowdown valve and from reciprocating compressor rod packing, total emissions can be

²⁵ “Reducing Methane Emissions From Rod Packing Systems.” *EPA.gov*, Natural Gas Star Partners, Oct. 2006, www.epa.gov/sites/production/files/2016-06/documents/ll_rodpack.pdf.

²⁶ “Using Pipeline Pump-Down Techniques.” *Environmental Protection Agency*, Natural Gas STAR Partners, Oct. 2006. https://www.epa.gov/sites/production/files/2016-06/documents/ll_pipeline.pdf

significantly reduced. Four options for reducing emissions when taking compressors off-line include:

- Keeping compressors pressurized when off-line.
- Connecting blowdown vent lines to the fuel gas system and recovering all, or a portion, of the vented gas to the fuel gas system.
- Installing static seals on compressor rod packing.
- Installing ejectors on compressor blowdown vent lines.

Keeping compressors fully pressurized when off-line achieves immediate payback—there are no capital costs and emissions are avoided by reducing the net leakage rate. Routing blowdown vent lines to the fuel gas system or to a lower pressure gas line reduces fuel costs for the compressor or other facility equipment, in addition to avoiding blowdown emissions. Static seals installed on compression rods eliminate gas leaking back through the rod packing while a compressor is shutdown under pressure. An ejector uses the discharge of an adjacent compressor as motive to pump blowdown or leaked gas from a shut down compressor into the suction of an operating compressor or a fuel gas system. Benefits of these practices include fewer bulk gas releases, lower leak rates, and lower fuel costs, with a payback in most cases of less than a year.²⁷

In addition to SoCalGas' work to reduce emissions through the EPA Natural Gas STAR program, corporate policy has historically supported minimizing emissions and protecting environmental resources. Excerpts from the Sempra Corporate Responsibility report make the following references in relation to methane emissions:

- “Not all greenhouse gases have the same impact on the environment. For example, one unit of methane has approximately 25 times the impact of one unit of carbon dioxide.” (page 26)
- “Since the company joined the Natural Gas Star program in 1993, SoCalGas has implemented practices that have resulted in the reduction of more than 800,000 metric tons of CO₂e, the equivalent of removing 169,000 cars from the road for a year. As a result of these efforts, SoCalGas has one of the lowest methane emission rates of natural gas utilities in the U.S.” (page 32)
- “Fugitive emissions (natural gas/methane emissions from leaks or other types of unintended or irregular releases) are our second most significant type of greenhouse gas emissions, behind emissions from stationary combustion. In 2016, fugitive emissions accounted for 94 percent of our methane emissions.” (page 32)²⁸
- Additional information on methane emissions can be found in the link below

²⁷ “Reducing Emissions When Taking Compressors Off-Line.” *Environmental Protection Agency, Natural Gas STAR Partners*, Oct. 2006, www.epa.gov/sites/production/files/2016-06/documents/ll_compressoroffline.pdf.

²⁸ “2016 Corporate Responsibility Report.” *Sempra Energy*, 15 June 2017, www.sempra.com/sustainability/2016-corporate-responsibility-report.

- SoCalGas Methane: <https://www.socalgas.com/stay-safe/methane-emissions>

The Sempra Environmental Policy also supports methane emission reduction, and states “Implement environmental practices where possible and economically prudent, including water reuse and conservation, recycling and waste minimization, greenhouse gas and other air emissions reductions, air quality improvements, and the adoption of building and facility standards;”²⁹ A copy of the Sempra Environmental Policy is attached.

Several company procedures and gas standards are in place to mitigate methane emissions, as well as regulations from other governing bodies, such as Pipeline and Hazardous Materials Safety Administration (PHMSA) and Division of Oil, Gas, and Geothermal Resources (DOGGR).

b) Alternative Proposal to BP or exemption? No

c) Proposed Plan:

SoCalGas is updating Gas Standards 184.06 and 182.0160 to clarify procedural changes to minimize methane emissions. Red-lined gas standards are attached.

d) Overlap with other regulations? What portion of the BP is incremental beyond those regulations?

SoCalGas is subject to other regulations that require specific practices to reduce, mitigate or control the release of methane emissions. All company operations follow the U.S. Department of Transportation Pipeline and Hazardous Materials Safety Administration (PHMSA) regulations for infrastructure monitoring and testing.

e) What technology is required to implement the best practice and why?

There are no technology needs to change the policy.

f) Will work require additional personnel and/or contract support? If so, please provide details.

No additional personnel is need to complete the activities in this Best Practice, this work fits within the scope of normal business activities.

g) What changes to existing operations are required? How will those changes be implemented?

In Best Practice 23 a centralized engineering group to coordinate methane emission minimization from operations is proposed. They would be responsible for coordinating cross-departmental efforts to build in time for methane evacuation.

²⁹ “Environmental Policy.” *Sempra Energy*, 1 Dec. 2017, www.sempra.com/sites/default/files/content/files/node-page/file-list/2017/environmental-policy-2017.pdf.

h) What are the new procedures to develop or existing procedures to modify? Please provide details.

SoCalGas is updating Gas Standards 184.06 and 182.0160 to clarify procedural changes to minimize methane emissions. Red-lined gas standards are attached. Detailed project management will be developed based on these policy changes so compliance is met.

i) Timeline for implementation (Milestones):

All milestones are listed as the approximate length of time to completion from the date cost recovery is approved:

- Policy review: 2 months
- Training development: 3-6 months
- Training of field department: 6-12 months
- Publishing policy changes: 12 months
- Field implementation completion: 12 months

j) Identify the range of factors or considerations used to determine cost-effectiveness of this measure, when costs estimates have been determined:

There is insufficient data to estimate emission reductions from the activities in this Best Practice.

k) Identify any cost benefits from this BP, when cost estimates are known:

There is insufficient data to estimate cost benefits associated with the activities in this Best Practice.

l) Do any incremental costs, if known, or benefits overlap with other BPs? If so, to which BP do they overlap, what are they, and how do they overlap?

Training needs addressed in best practices 3, 4, 5, 6, 7, and 23 will be affected by policy changes in this best practice.

m) Anticipated Emissions Reductions from this BP:

There is insufficient data to estimate emission reductions from the activities in this Best Practice.

2015 Baseline Emissions affected, where known:

N/A

n) Calculation Methodology:

N/A

o) Additional Comments:

N/A

p) Overlap with Safety: N/A
SUPPLEMENTAL INFORMATION
a) Technology:
b) Changes to Operations: The accompanying attachments have been redacted to remove non-responsive, non-relevant employee information. Attachment D: Red-lined draft of Gas Standard 184.06 Attachment E: Red-lined draft of Gas Standard 182.0160
c) Research or Studies:
d) Other:

Best Practice 6: Methane Evacuation Work Orders Policy

2018 LEAK ABATEMENT COMPLIANCE PLAN TEMPLATE (D.17-06-015)

PART 1: OVERVIEW	
a) Best Practice: #6	b) Status: Work pending approval of AL 5211
<p>Written company policy that requires that for any high pressure distribution (above 60 psig), transmission or underground storage infrastructure projects requiring evacuating methane, Work Planners shall clearly delineate, in procedural documents, such as work orders used in the field, the steps required to safely and efficiently reduce the pressure in the lines, prior to lines being vented, considering alternative potential sources of supply to reliably serve customers. Exact wording TBD by the company and approved by the CPUC, in consultation with CARB, as part of the Compliance Plan filing.</p>	
PART 2: BEST PRACTICE DETAILS	
a) Historic work:	
<p>SoCalGas has proactively used internal policies and procedures that require operations to take measures to minimize methane emissions during venting. For example, Gas Standard 223.0145, Planning Shutdowns for Transmission and Storage, states: “Plan to minimize gas blown to atmosphere through the use of Distribution facilities to reduce gas pipeline inventory.”</p> <p>SoCalGas became a founding member of The EPA Natural Gas STAR Program in 1993. Through this program, SoCalGas has implemented methane reducing technologies and practices and documented voluntary emission reduction activities. SoCalGas continuously evaluates methane emission reduction opportunities, implements cost-effective methane reduction projects where feasible, and annually reports methane emission reduction actions to the EPA. Total methane savings by SoCalGas through implementation of methane reduction practices between 1993 and 2016 were 2,620,910,000 cubic feet.</p> <p>SoCalGas has long recognized the need to voluntarily reduce methane emissions. The company has contributed to the elimination of methane emissions by employing several different best practices, including:</p> <ul style="list-style-type: none"> • <u>Directed Inspection & Maintenance (DI&M)</u>; A DI&M program concentrates on components that are prone to leak enough methane to make repairs cost-effective. Such components include valve packing, pneumatic controllers and open-ended lines such as vent and drain connections, blowdown lines, pneumatic engine starter motors, and pressure relief valves.³⁰ 	

³⁰ “Conduct Directed Inspection and Maintenance at Remote Sites.” *EPA.gov*, 2011, www.epa.gov/natural-gas-star-program/conduct-directed-inspection-and-maintenance-remote-sites.

- Identify and rehabilitate leaky distribution pipe; Through regular leak surveys, SoCalGas has identified and repaired or replaced pipeline that with high leak rates.
- Replace compressor rod packing systems; Reciprocating compressors in the natural gas industry leak natural gas during normal operation. Areas of high leak frequency include flanges, valves, and fittings located on compressors. The highest volume of gas loss, however, is associated with piston rod packing systems. Packing systems are used to maintain a tight seal around the piston rod, preventing the gas compressed to high pressure in the compressor cylinder from leaking, while allowing the rod to move freely. Compressor rod packing consists of a series of flexible rings that fit around the shaft to create a seal against leakage. Packing rings are held in place by a set of packing cups, normally one for each pair of rings, and kept tight against the shaft by a surrounding spring. A “nose gasket” on the end of the packing case prevents leaks around the packing cups. Leaking gases are vented to the atmosphere through packing vents on the flange. Leakage can be reduced through proper monitoring and a cost-effective schedule for replacing packing rings and piston rods. New ring materials and new designs for packing cases are emerging that should reduce emissions in the future.³¹
- Reduce system pressure for maintenance blowdowns; Operators of natural gas pipeline systems routinely reduce line pressure and discharge gas from pipeline sections to provide safe working conditions during maintenance and repair activities. Typically, operators block the smallest possible linear section of the pipeline and depressurize it by venting gas to the atmosphere. Using pump-down techniques to lower gas line pressure before performing maintenance and repair activities is an effective way to reduce emissions and yield significant economic savings. Pipeline pump-down techniques involve using in-line compressors either alone or in sequence with portable compressors. Using in-line compressors is almost always justifiable because there are no capital costs, and payback is immediate. The cost-effectiveness of also using a portable compressor to increase gas recovery, however, depends greatly on site-specific factors and operating costs. Regardless of the pump-down technique selected, emission reductions are directly proportional to how much pipeline pressure is reduced before venting occurs. Pipeline pump-down techniques are most economical for larger volume, higher pressure gas lines and work most effectively for planned maintenance activities and cases in which sufficient manifolding exists to connect a portable compressor.³²
- Redesign blowdown process in Emergency Shutdown practices; Compressors are used throughout the natural gas industry to move natural gas from production and processing sites to customer distribution systems. Compressors must periodically be taken off-line for maintenance, operational stand-by, or emergency shut down testing, and as a result, methane may be released to the atmosphere from a number of sources. When compressor units are shut down, typically the high pressure gas remaining within the compressors and associated piping between isolation valves is vented to the atmosphere (“blowdown”) or to a flare. In addition to blowdown emissions, a depressurized system may continue to leak gas from faulty or improperly sealed unit isolation valves. Simple changes in operating practices and in the design of blowdown systems can save money and significantly reduce methane blowdown valve and from reciprocating compressor rod packing, total emissions can be

³¹ “Reducing Methane Emissions From Rod Packing Systems.” *EPA.gov*, Natural Gas Star Partners, Oct. 2006, www.epa.gov/sites/production/files/2016-06/documents/ll_rodpack.pdf.

³² “Using Pipeline Pump-Down Techniques.” *Environmental Protection Agency*, Natural Gas STAR Partners, Oct. 2006. https://www.epa.gov/sites/production/files/2016-06/documents/ll_pipeline.pdf

significantly reduced. Four options for reducing emissions when taking compressors off-line include:

- Keeping compressors pressurized when off-line.
- Connecting blowdown vent lines to the fuel gas system and recovering all, or a portion, of the vented gas to the fuel gas system.
- Installing static seals on compressor rod packing.
- Installing ejectors on compressor blowdown vent lines.

Keeping compressors fully pressurized when off-line achieves immediate payback—there are no capital costs and emissions are avoided by reducing the net leakage rate. Routing blowdown vent lines to the fuel gas system or to a lower pressure gas line reduces fuel costs for the compressor or other facility equipment, in addition to avoiding blowdown emissions. Static seals installed on compression rods eliminate gas leaking back through the rod packing while a compressor is shutdown under pressure. An ejector uses the discharge of an adjacent compressor as motive to pump blowdown or leaked gas from a shutdown compressor into the suction of an operating compressor or a fuel gas system. Benefits of these practices include fewer bulk gas releases, lower leak rates, and lower fuel costs, with a payback in most cases of less than a year.³³

In addition to SoCalGas' work to reduce emissions through the EPA Natural Gas STAR program, corporate policy has historically supported minimizing emissions and protecting environmental resources. Excerpts from the Sempra Corporate Responsibility report make the following references in relation to methane emissions:

- “Not all greenhouse gases have the same impact on the environment. For example, one unit of methane has approximately 25 times the impact of one unit of carbon dioxide.” (page 26)
- “Since the company joined the Natural Gas Star program in 1993, SoCalGas has implemented practices that have resulted in the reduction of more than 800,000 metric tons of CO₂e, the equivalent of removing 169,000 cars from the road for a year. As a result of these efforts, SoCalGas has one of the lowest methane emission rates of natural gas utilities in the U.S.” (page 32)
- “Fugitive emissions (natural gas/methane emissions from leaks or other types of unintended or irregular releases) are our second most significant type of greenhouse gas emissions, behind emissions from stationary combustion. In 2016, fugitive emissions accounted for 94 percent of our methane emissions.” (page 32)³⁴
- Additional information on methane emissions can be found in the link below

³³ “Reducing Emissions When Taking Compressors Off-Line.” *Environmental Protection Agency*, Natural Gas STAR Partners, Oct. 2006, www.epa.gov/sites/production/files/2016-06/documents/II_compressoroffline.pdf.

³⁴ “2016 Corporate Responsibility Report.” *Sempra Energy*, 15 June 2017, www.sempra.com/sustainability/2016-corporate-responsibility-report.

- SoCalGas Methane: <https://www.socalgas.com/stay-safe/methane-emissions>

The Sempra Environmental Policy also supports methane emission reduction, and states “Implement environmental practices where possible and economically prudent, including water reuse and conservation, recycling and waste minimization, greenhouse gas and other air emissions reductions, air quality improvements, and the adoption of building and facility standards;”³⁵ A copy of the Sempra Environmental Policy is attached.

Several company procedures and gas standards are in place to mitigate methane emissions, as well as regulations from other governing bodies, such as Pipeline and Hazardous Materials Safety Administration (PHMSA) and Division of Oil, Gas, and Geothermal Resources (DOGGR).

b) Alternative Proposal to BP or exemption? No

c) Proposed Plan:

SoCalGas is updating Gas Standards 184.06, 184.0015, 184.0060, and 182.0160 to clarify procedural changes to minimize methane emissions. Red-lined gas standards are attached.

d) Overlap with other regulations? What portion of the BP is incremental beyond those regulations?

SoCalGas is subject to other regulations that require specific practices to reduce, mitigate or control the release of methane emissions. All company operations follow the U.S. Department of Transportation Pipeline and Hazardous Materials Safety Administration (PHMSA) regulations for infrastructure monitoring and testing.

e) What technology is required to implement the best practice and why?

There are no technology needs to change the policy.

f) Will work require additional personnel and/or contract support? If so, please provide details.

No additional personnel is need to complete the activities in this Best Practice, this work fits within the scope of normal business activities.

g) What changes to existing operations are required? How will those changes be implemented?

In Best Practice 23 a centralized engineering group to coordinate methane emission minimization from operations is proposed. They would be responsible for coordinating cross-departmental efforts to build in time for methane evacuation.

³⁵ “Environmental Policy.” *Sempra Energy*, 1 Dec. 2017, www.sempra.com/sites/default/files/content/files/node-page/file-list/2017/environmental-policy-2017.pdf.

h) What are the new procedures to develop or existing procedures to modify? Please provide details.

SoCalGas is updating Gas Standards 184.06, 184.0015, 184.0060, and 182.0160 to clarify procedural changes to minimize methane emissions. Red-lined gas standards are attached. Detailed project management will be developed based on these policy changes so compliance is met.

i) Timeline for implementation (Milestones):

All milestones are listed as the approximate length of time to completion from the date cost recovery is approved.

- Policy review: 2 months
- Training development: 3-6 months
- Training of field department: 6-12 months
- Publishing policy changes: 12 months
- Field implementation completion: 12 months

j) Identify the range of factors or considerations used to determine cost-effectiveness of this measure, when costs estimates have been determined:

There is insufficient data to estimate emission reductions from the activities in this Best Practice.

k) Identify any cost benefits from this BP, when cost estimates are known:

There is insufficient data to estimate cost benefits associated with the activities in this Best Practice.

l) Do any incremental costs, if known, or benefits overlap with other BPs? If so, to which BP do they overlap, what are they, and how do they overlap?

Training needs addressed in best practices 3, 4, 5, 6, 7, and 23 will be affected by policy changes in this best practice.

m) Anticipated Emissions Reductions from this BP:

There is insufficient data to estimate emission reductions from the activities in this Best Practice.

2015 Baseline Emissions affected, where known:

N/A

n) Calculation Methodology:

N/A

o) Additional Comments:

N/A

p) Overlap with Safety: N/A
SUPPLEMENTAL INFORMATION
a) Technology:
b) Changes to Operations: The accompanying attachments have been redacted to remove non-responsive, non-relevant employee information. Attachment D: Red-lined draft of Gas Standard 184.06 Attachment E: Red-lined draft of Gas Standard 182.0160 Attachment F: Red-lined draft of Gas Standard 184.0015 Attachment G: Red-lined draft of Gas Standard 184.0060
c) Research or Studies:
d) Other:

Best Practice 7: Bundling Work Policy

2018 LEAK ABATEMENT COMPLIANCE PLAN TEMPLATE (D.17-06-015)

PART 1: OVERVIEW	
a) Best Practice: #7	b) Status: Work pending approval of AL 5211
<p>Written company policy requiring bundling of work, whenever practicable, to prevent multiple venting of the same piping consistent with safe operations and considering alternative potential sources of supply to reliably serve customers. Company policy shall define situations where work bundling is not practicable. Exact wording TBD by the company and approved by the CPUC, in consultation with CARB, as part of the Compliance Plan filing.</p>	
PART 2: BEST PRACTICE DETAILS	
a) Historic work:	
<p>SoCalGas has proactively used internal policies and procedures that require operations to take measures to minimize methane emissions during venting. For example, Gas Standard 223.0145, Planning Shutdowns for Transmission and Storage, states: "Working with Gas Control and Distribution Region Technical Services, plan to minimize gas blown to atmosphere through the use of Distribution facilities to reduce gas pipeline inventory."</p>	
<p>SoCalGas became a founding member of The EPA Natural Gas STAR Program in 1993. Through this program, SoCalGas has implemented methane reducing technologies and practices and documented voluntary emission reduction activities. SoCalGas continuously evaluates methane emission reduction opportunities, implements cost-effective methane reduction projects where feasible, and annually reports methane emission reduction actions to the EPA. Total savings by SoCalGas through implementation of methane reduction practices between 1993 and 2016 were 2,620,910,000 cubic feet of methane.</p>	
<p>SoCalGas has long recognized the need to voluntarily reduce methane emissions. The company has contributed to the elimination of methane emissions by employing several different best practices, including:</p>	
<ul style="list-style-type: none">• <u>Directed Inspection & Maintenance (DI&M)</u>; A DI&M program concentrates on components that are prone to leak enough methane to make repairs cost-effective. Such components include valve packing, pneumatic controllers and open-ended lines such as vent and drain connections, blowdown lines, pneumatic engine starter motors, and pressure relief valves.³⁶	

³⁶ "Conduct Directed Inspection and Maintenance at Remote Sites." *EPA.gov*, 2011, www.epa.gov/natural-gas-star-program/conduct-directed-inspection-and-maintenance-remote-sites.

- Identify and rehabilitate leaky distribution pipe; Through regular leak surveys, SoCalGas has identified and repaired or replaced pipeline that with high leak rates.
- Replace compressor rod packing systems; Reciprocating compressors in the natural gas industry leak natural gas during normal operation. Areas of high leak frequency include flanges, valves, and fittings located on compressors. The highest volume of gas loss, however, is associated with piston rod packing systems. Packing systems are used to maintain a tight seal around the piston rod, preventing the gas compressed to high pressure in the compressor cylinder from leaking, while allowing the rod to move freely. Compressor rod packing consists of a series of flexible rings that fit around the shaft to create a seal against leakage. Packing rings are held in place by a set of packing cups, normally one for each pair of rings, and kept tight against the shaft by a surrounding spring. A “nose gasket” on the end of the packing case prevents leaks around the packing cups. Leaking gases are vented to the atmosphere through packing vents on the flange. Leakage can be reduced through proper monitoring and a cost-effective schedule for replacing packing rings and piston rods. New ring materials and new designs for packing cases are emerging that should reduce emissions in the future.³⁷
- Reduce system pressure for maintenance blowdowns; Operators of natural gas pipeline systems routinely reduce line pressure and discharge gas from pipeline sections to provide safe working conditions during maintenance and repair activities. Typically, operators block the smallest possible linear section of the pipeline and depressurize it by venting gas to the atmosphere. Using pump-down techniques to lower gas line pressure before performing maintenance and repair activities is an effective way to reduce emissions and yield significant economic savings. Pipeline pump-down techniques involve using in-line compressors either alone or in sequence with portable compressors. Using in-line compressors is almost always justifiable because there are no capital costs, and payback is immediate. The cost-effectiveness of also using a portable compressor to increase gas recovery, however, depends greatly on site-specific factors and operating costs. Regardless of the pump-down technique selected, emission reductions are directly proportional to how much pipeline pressure is reduced before venting occurs. Pipeline pump-down techniques are most economical for larger volume, higher pressure gas lines and work most effectively for planned maintenance activities and cases in which sufficient manifolding exists to connect a portable compressor.³⁸
- Redesign blowdown process in Emergency Shutdown practices; Compressors are used throughout the natural gas industry to move natural gas from production and processing sites to customer distribution systems. Compressors must periodically be taken off-line for maintenance, operational stand-by, or emergency shut down testing, and as a result, methane may be released to the atmosphere from a number of sources. When compressor units are shut down, typically the high pressure gas remaining within the compressors and associated piping between isolation valves is vented to the atmosphere (“blowdown”) or to a flare. In addition to blowdown emissions, a depressurized system may continue to leak gas from faulty or improperly sealed unit isolation valves. Simple changes in operating practices and in the design of blowdown systems can save money and significantly reduce methane blowdown valve and from reciprocating compressor rod packing, total emissions can be

³⁷ “Reducing Methane Emissions From Rod Packing Systems.” *EPA.gov*, Natural Gas Star Partners, Oct. 2006, www.epa.gov/sites/production/files/2016-06/documents/II_rodpack.pdf.

³⁸ “Using Pipeline Pump-Down Techniques.” *Environmental Protection Agency*, Natural Gas STAR Partners, Oct. 2006. https://www.epa.gov/sites/production/files/2016-06/documents/II_pipeline.pdf

significantly reduced. Four options for reducing emissions when taking compressors off-line include:

- Keeping compressors pressurized when off-line.
- Connecting blowdown vent lines to the fuel gas system and recovering all, or a portion, of the vented gas to the fuel gas system.
- Installing static seals on compressor rod packing.
- Installing ejectors on compressor blowdown vent lines.

Keeping compressors fully pressurized when off-line achieves immediate payback—there are no capital costs and emissions are avoided by reducing the net leakage rate. Routing blowdown vent lines to the fuel gas system or to a lower pressure gas line reduces fuel costs for the compressor or other facility equipment, in addition to avoiding blowdown emissions. Static seals installed on compression rods eliminate gas leaking back through the rod packing while a compressor is shutdown under pressure. An ejector uses the discharge of an adjacent compressor as motive to pump blowdown or leaked gas from a shut down compressor into the suction of an operating compressor or a fuel gas system. Benefits of these practices include fewer bulk gas releases, lower leak rates, and lower fuel costs, with a payback in most cases of less than a year.³⁹

In addition to SoCalGas' work to reduce emissions through the EPA Natural Gas STAR program, corporate policy has historically supported minimizing emissions and protecting environmental resources. Excerpts from the Sempra Corporate Responsibility report make the following references in relation to methane emissions:

- “Not all greenhouse gases have the same impact on the environment. For example, one unit of methane has approximately 25 times the impact of one unit of carbon dioxide.” (page 26)
- “Since the company joined the Natural Gas Star program in 1993, SoCalGas has implemented practices that have resulted in the reduction of more than 800,000 metric tons of CO₂e, the equivalent of removing 169,000 cars from the road for a year. As a result of these efforts, SoCalGas has one of the lowest methane emission rates of natural gas utilities in the U.S.” (page 32)
- “Fugitive emissions (natural gas/methane emissions from leaks or other types of unintended or irregular releases) are our second most significant type of greenhouse gas emissions, behind emissions from stationary combustion. In 2016, fugitive emissions accounted for 94 percent of our methane emissions.” (page 32)⁴⁰
- Additional information on methane emissions can be found in the link below

³⁹ “Reducing Emissions When Taking Compressors Off-Line.” *Environmental Protection Agency*, Natural Gas STAR Partners, Oct. 2006, www.epa.gov/sites/production/files/2016-06/documents/ll_compressoroffline.pdf.

⁴⁰ “2016 Corporate Responsibility Report.” *Sempra Energy*, 15 June 2017, www.sempra.com/sustainability/2016-corporate-responsibility-report.

- SoCalGas Methane: <https://www.socalgas.com/stay-safe/methane-emissions>

The Sempra Environmental Policy also supports methane emission reduction, and states “Implement environmental practices where possible and economically prudent, including water reuse and conservation, recycling and waste minimization, greenhouse gas and other air emissions reductions, air quality improvements, and the adoption of building and facility standards;”⁴¹ A copy of the Sempra Environmental Policy is attached.

Several company procedures and gas standards are in place to mitigate methane emissions, as well as regulations from other governing bodies, such as Pipeline and Hazardous Materials Safety Administration (PHMSA) and Division of Oil, Gas, and Geothermal Resources (DOGGR).

b) Alternative Proposal to BP or exemption? No

c) Proposed Plan:

SoCalGas is updating Gas Standards 184.06, 184.0015, 184.0060, and 182.0160 to clarify procedural changes to minimize methane emissions. Red-lined gas standards are attached.

d) Overlap with other regulations? What portion of the BP is incremental beyond those regulations?

SoCalGas is subject to other regulations that require specific practices to reduce, mitigate or control the release of methane emissions. All company operations follow the U.S. Department of Transportation Pipeline and Hazardous Materials Safety Administration (PHMSA) regulations for infrastructure monitoring and testing.

e) What technology is required to implement the best practice and why?

The IT systems proposed in Best Practice 9 will support the bundling of work as recommended in this Best Practice.

f) Will work require additional personnel and/or contract support? If so, please provide details.

No additional personnel is need to complete the activities in this Best Practice, this work fits within the scope of normal business activities. However, implementation will require additional personnel, which is covered in Best Practice 23.

g) What changes to existing operations are required? How will those changes be implemented?

In Best Practice 23 a centralized engineering group to coordinate methane emission minimization from operations is proposed. They would be responsible for coordinating cross-departmental efforts to build in time for methane evacuation and bundle work when appropriate.

⁴¹ “Environmental Policy.” *Sempra Energy*, 1 Dec. 2017, www.sempra.com/sites/default/files/content/files/node-page/file-list/2017/environmental-policy-2017.pdf.

h) What are the new procedures to develop or existing procedures to modify? Please provide details.

SoCalGas is updating Gas Standards 184.06, 184.0015, 184.0060, and 182.0160 to clarify procedural changes to minimize methane emissions. Red-lined gas standards are attached. Detailed project management will be developed based on these policy changes so compliance is met.

i) Timeline for implementation (Milestones):

All milestones are listed as the approximate length of time to completion from the date cost recovery is approved:

- Policy review: 2 months
- Training development: 3-6 months
- Training of field department: 6-12 months
- Publishing policy changes: 12 months
- Field implementation completion: 12 months

j) Identify the range of factors or considerations used to determine cost-effectiveness of this measure, when costs estimates have been determined:

Emission reductions resulting from the implementation of this policy change are captured in Best Practice 23.

k) Identify any cost benefits from this BP, when cost estimates are known:

Cost benefits associated with the activities in this Best Practice are captured in Best Practice 23.

l) Do any incremental costs, if known, or benefits overlap with other BPs? If so, to which BP do they overlap, what are they, and how do they overlap?

Training needs addressed in best practices 3, 4, 5, 6, 7, and 23 will be affected by policy changes in this best practice. Best Practice 9 includes IT systems that will enable bundling of work and Best Practice 23 includes labor for the incremental project management needs.

m) Anticipated Emissions Reductions from this BP:

Emission reductions resulting from the implementation of this policy change are captured in Best Practice 23.

2015 Baseline Emissions affected, where known:

N/A

n) Calculation Methodology:

N/A

o) Additional Comments: N/A
p) Overlap with Safety: N/A
SUPPLEMENTAL INFORMATION
a) Technology:
b) Changes to Operations: The accompanying attachments have been redacted to remove non-responsive, non-relevant employee information. Attachment D: Red-lined draft of Gas Standard 184.06 Attachment E: Red-lined draft of Gas Standard 182.0160 Attachment F: Red-lined draft of Gas Standard 184.0015 Attachment G: Red-lined draft of Gas Standard 184.0060
c) Research or Studies:
d) Other:

Best Practice 8: Company Emergency Procedures

2018 LEAK ABATEMENT COMPLIANCE PLAN TEMPLATE (D.17-06-015)

PART 1: OVERVIEW	
a) Best Practice: #8	b) Status: Work pending approval of AL 5211
<p>Written company emergency procedures which describe the actions company staff will take to prevent, minimize and/or stop the uncontrolled release of methane from the gas system or storage facility consistent with safe operations and considering alternative potential sources of supply to reliably serve customers. Exact wording TBD by the company and approved by the CPUC, in consultation with CARB, as part of the Compliance Plan filing.</p>	
PART 2: BEST PRACTICE DETAILS	
a) Historic work:	
<p>SoCalGas has proactively used internal policies and procedures that require operations to take measures to minimize methane emissions during venting. For example, Gas Standard 223.0145, Planning Shutdowns for Transmission and Storage, states: "Plan to minimize gas blown to atmosphere through the use of Distribution facilities to reduce gas pipeline inventory."</p> <p>SoCalGas became a founding member of The EPA Natural Gas STAR Program in 1993. Through this program, SoCalGas has implemented methane reducing technologies and practices and documented voluntary emission reduction activities. SoCalGas continuously evaluates methane emission reduction opportunities, implements cost-effective methane reduction projects where feasible, and annually reports methane emission reduction actions to the EPA. Total savings by SoCalGas through implementation of methane reduction practices between 1993 and 2016 were 2,620,910,000 cubic feet of methane.</p> <p>SoCalGas has long recognized the need to voluntarily reduce methane emissions. The company has contributed to the elimination of methane emissions by employing several different best practices, including:</p> <ul style="list-style-type: none"> • <u>Directed Inspection & Maintenance (DI&M)</u>; A DI&M program concentrates on components that are prone to leak enough methane to make repairs cost-effective. Such components include valve packing, pneumatic controllers and open-ended lines such as vent and drain connections, blowdown lines, pneumatic engine starter motors, and pressure relief valves.⁴² • <u>Identify and rehabilitate leaky distribution pipe</u>; Through regular leak surveys, SoCalGas has identified and repaired or replaced pipeline that with high leak rates. 	

⁴² "Conduct Directed Inspection and Maintenance at Remote Sites." *EPA.gov*, 2011, www.epa.gov/natural-gas-star-program/conduct-directed-inspection-and-maintenance-remote-sites.

- Replace compressor rod packing systems; Reciprocating compressors in the natural gas industry leak natural gas during normal operation. Areas of high leak frequency include flanges, valves, and fittings located on compressors. The highest volume of gas loss, however, is associated with piston rod packing systems. Packing systems are used to maintain a tight seal around the piston rod, preventing the gas compressed to high pressure in the compressor cylinder from leaking, while allowing the rod to move freely. Compressor rod packing consists of a series of flexible rings that fit around the shaft to create a seal against leakage. Packing rings are held in place by a set of packing cups, normally one for each pair of rings, and kept tight against the shaft by a surrounding spring. A “nose gasket” on the end of the packing case prevents leaks around the packing cups. Leaking gases are vented to the atmosphere through packing vents on the flange. Leakage can be reduced through proper monitoring and a cost-effective schedule for replacing packing rings and piston rods. New ring materials and new designs for packing cases are emerging that should reduce emissions in the future.⁴³
- Reduce system pressure for maintenance blowdowns; Operators of natural gas pipeline systems routinely reduce line pressure and discharge gas from pipeline sections to provide safe working conditions during maintenance and repair activities. Typically, operators block the smallest possible linear section of the pipeline and depressurize it by venting gas to the atmosphere. Using pump-down techniques to lower gas line pressure before performing maintenance and repair activities is an effective way to reduce emissions and yield significant economic savings. Pipeline pump-down techniques involve using in-line compressors either alone or in sequence with portable compressors. Using in-line compressors is almost always justifiable because there are no capital costs, and payback is immediate. The cost-effectiveness of also using a portable compressor to increase gas recovery, however, depends greatly on site-specific factors and operating costs. Regardless of the pump-down technique selected, emission reductions are directly proportional to how much pipeline pressure is reduced before venting occurs. Pipeline pump-down techniques are most economical for larger volume, higher pressure gas lines and work most effectively for planned maintenance activities and cases in which sufficient manifolding exists to connect a portable compressor.⁴⁴
- Redesign blowdown process in Emergency Shutdown practices; Compressors are used throughout the natural gas industry to move natural gas from production and processing sites to customer distribution systems. Compressors must periodically be taken off-line for maintenance, operational stand-by, or emergency shut down testing, and as a result, methane may be released to the atmosphere from a number of sources. When compressor units are shut down, typically the high pressure gas remaining within the compressors and associated piping between isolation valves is vented to the atmosphere (‘blowdown’) or to a flare. In addition to blowdown emissions, a depressurized system may continue to leak gas from faulty or improperly sealed unit isolation valves. Simple changes in operating practices and in the design of blowdown systems can save money and significantly reduce methane blowdown valve and from reciprocating compressor rod packing, total emissions can be significantly reduced. Four options for reducing emissions when taking compressors off-line include:

⁴³ “Reducing Methane Emissions From Rod Packing Systems.” *EPA.gov*, Natural Gas Star Partners, Oct. 2006, www.epa.gov/sites/production/files/2016-06/documents/ll_rodpack.pdf.

⁴⁴ “Using Pipeline Pump-Down Techniques.” *Environmental Protection Agency*, Natural Gas STAR Partners, Oct. 2006. https://www.epa.gov/sites/production/files/2016-06/documents/ll_pipeline.pdf

- Keeping compressors pressurized when off-line.
- Connecting blowdown vent lines to the fuel gas system and recovering all, or a portion, of the vented gas to the fuel gas system.
- Installing static seals on compressor rod packing.
- Installing ejectors on compressor blowdown vent lines.

Keeping compressors fully pressurized when off-line achieves immediate payback—there are no capital costs and emissions are avoided by reducing the net leakage rate. Routing blowdown vent lines to the fuel gas system or to a lower pressure gas line reduces fuel costs for the compressor or other facility equipment, in addition to avoiding blowdown emissions. Static seals installed on compression rods eliminate gas leaking back through the rod packing while a compressor is shutdown under pressure. An ejector uses the discharge of an adjacent compressor as motive to pump blowdown or leaked gas from a shut down compressor into the suction of an operating compressor or a fuel gas system. Benefits of these practices include fewer bulk gas releases, lower leak rates, and lower fuel costs, with a payback in most cases of less than a year.⁴⁵

In addition to SoCalGas' work to reduce emissions through the EPA Natural Gas STAR program, corporate policy has historically supported minimizing emissions and protecting environmental resources. Excerpts from the Sempra Corporate Responsibility report make the following references in relation to methane emissions:

- “Not all greenhouse gases have the same impact on the environment. For example, one unit of methane has approximately 25 times the impact of one unit of carbon dioxide.” (page 26)
- “Since the company joined the Natural Gas Star program in 1993, SoCalGas has implemented practices that have resulted in the reduction of more than 800,000 metric tons of CO₂e, the equivalent of removing 169,000 cars from the road for a year. As a result of these efforts, SoCalGas has one of the lowest methane emission rates of natural gas utilities in the U.S.” (page 32)
- “Fugitive emissions (natural gas/methane emissions from leaks or other types of unintended or irregular releases) are our second most significant type of greenhouse gas emissions, behind emissions from stationary combustion. In 2016, fugitive emissions accounted for 94 percent of our methane emissions.” (page 32)⁴⁶
- Additional information on methane emissions can be found in the link below
 - SoCalGas Methane: <https://www.socalgas.com/stay-safe/methane-emissions>

⁴⁵ “Reducing Emissions When Taking Compressors Off-Line.” *Environmental Protection Agency*, Natural Gas STAR Partners, Oct. 2006, www.epa.gov/sites/production/files/2016-06/documents/ll_compressoroffline.pdf.

⁴⁶ “2016 Corporate Responsibility Report.” *Sempra Energy*, 15 June 2017, www.sempra.com/sustainability/2016-corporate-responsibility-report.

The Sempra Environmental Policy also supports methane emission reduction, and states “Implement environmental practices where possible and economically prudent, including water reuse and conservation, recycling and waste minimization, greenhouse gas and other air emissions reductions, air quality improvements, and the adoption of building and facility standards;”⁴⁷ A copy of the Sempra Environmental Policy is attached.

Several company procedures and gas standards are in place to mitigate methane emissions, as well as regulations from other governing bodies, such as Pipeline and Hazardous Materials Safety Administration (PHMSA) and Division of Oil, Gas, and Geothermal Resources (DOGGR).

b) Alternative Proposal to BP or exemption? Yes

c) Proposed Plan:

SoCalGas has existing emergency operating procedures that prioritize actions taken during emergency situations. Gas Standards 183.03 and 183.0110 are attached and document the actions taken during this type of situation, with safety as the highest priority. After reviewing Gas Standards 183.03 and 183.0110, SoCalGas did not identify any modifications to emergency procedures or opportunities for emissions reductions, as it could interfere with safety procedures. The intent of SB 1371 was not to deprioritize safety.

If the situation is not a true emergency where safety is a concern, and a controlled blowdown can be achieved, Gas Standard 183.0110 references Gas Standard 223.0145, *Planning Shutdowns for Transmission and Storage*, which has been redlined to reflect minimization of methane emissions.

d) Overlap with other regulations? What portion of the BP is incremental beyond those regulations?

SoCalGas is subject to other regulations that require specific practices to reduce, mitigate or control the release of methane emissions. All company operations follow the U.S. Department of Transportation Pipeline and Hazardous Materials Safety Administration (PHMSA) regulations for infrastructure monitoring and testing.

e) What technology is required to implement the best practice and why?

There are no technology needs associated with this Best Practice.

f) Will work require additional personnel and/or contract support? If so, please provide details.

No additional personnel is need to complete the activities in this Best Practice, this work fits within the scope of normal business activities.

⁴⁷ “Environmental Policy.” *Sempra Energy*, 1 Dec. 2017, www.sempra.com/sites/default/files/content/files/node-page/file-list/2017/environmental-policy-2017.pdf.

g) What changes to existing operations are required? How will those changes be implemented?

No operational changes are required as part of this Best Practice.

h) What are the new procedures to develop or existing procedures to modify? Please provide details.

SoCalGas has existing procedures in place, no procedural changes are needed.

i) Timeline for implementation (Milestones):

N/A

j) Identify the range of factors or considerations used to determine cost-effectiveness of this measure, when costs estimates have been determined:

There is insufficient data to estimate emission reductions from the activities in this Best Practice.

k) Identify any cost benefits from this BP, when cost estimates are known:

There is insufficient data to estimate cost benefits associated with the activities in this Best Practice.

l) Do any incremental costs, if known, or benefits overlap with other BPs? If so, to which BP do they overlap, what are they, and how do they overlap?

N/A

m) Anticipated Emissions Reductions from this BP:

There is insufficient data to estimate emission reductions from the activities in this Best Practice.

2015 Baseline Emissions affected, where known:

N/A

n) Calculation Methodology:

N/A

o) Additional Comments:

N/A

p) Overlap with Safety:

SoCalGas has existing emergency operating procedures that prioritize actions taken during emergency situations. Gas Standards 183.0110 and 183.03 are attached and document the actions taken during this type of situation, with safety as the highest priority.

SUPPLEMENTAL INFORMATION
a) Technology:
b) Changes to Operations: The accompanying attachments have been redacted to remove non-responsive, non-relevant employee and disaster recovery strategy and plan information. Attachment H: Gas Standard 183.0110 Attachment I: Gas Standard 183.03 Attachment J: Red-lined draft Gas Standard 223.0145
c) Research or Studies:
d) Other:

Best Practice 9: Recordkeeping

2018 LEAK ABATEMENT COMPLIANCE PLAN TEMPLATE (D.17-06-015)

PART 1: OVERVIEW	
a) Best Practice: 9	b) Status: Work pending approval of AL 5211
<p>Written Company Policy directing the gas business unit to maintain records of all SB 1371 Annual Emissions Inventory Report methane emissions and leaks, including the calculations, data and assumptions used to derive the volume of methane released. Records are to be maintained in accordance with G.O. 112 F and succeeding revisions, and 49 CFR 192. Currently, the record retention time in G.O. 112 F is at least 75 years for the transmission system. 49 CFR 192.1011 requires a record retention time of at least 10 years for the distribution system. Exact wording TBD by the company and approved by the CPUC, in consultation with CARB, as part of the Compliance Plan filing.</p>	
PART 2: BEST PRACTICE DETAILS	
a) Historic work:	
<p>Developing the Annual Emissions Report required by SB 1371 requires querying various records which are currently stored in varying formats, locations, databases, and with various record owners. Different record keeping practices have evolved over time and as new record-keeping requirements emerge, various new systems have been developed. These different record-keeping systems are not compatible and data is not easily shared, integrated, or queried. This makes report generation a time-consuming manual process. An additional challenge is that these systems weren't designed for generating reports for emissions, but rather for billing or operational record keeping. Because of this, the records may use varying types of nomenclature relevant to specific departments. Querying records from numerous departments in the company and combining them to generate a single report is quite challenging. To generate annual emissions reports, data is pulled from thirty-six separate reports, which are generated from fourteen different systems. This has essentially been a full-time job for four employees to generate an annual report and work with the various departments to compile and analyze the data so it is in the format needed for consistent report generation.</p>	
b) Alternative Proposal to BP or exemption?	
N/A	
c) Proposed Plan:	
<p>Accurate reporting of methane emissions and leaks, including estimation methodologies and assumptions, is critical to provide regulatory compliance and respond to audits or data requests. A written company policy is needed so these records are maintained for all SB 1371 data. This includes measured emissions and leaks, as well as estimated emissions and leaks, including calculations, data,</p>	

and assumptions to derive the volume of methane released. This policy will be generated and stored in SoCalGas' Department Records Retention Schedule with User Records.

SoCalGas proposes developing a centralized database to incorporate SB 1371 records. This will enable automation of reporting. Annual reporting is a compilation of thirty-six reports generated from fourteen different systems. SoCalGas is exploring architecture of such a system and in 2019 will begin mapping out the scope of this project. Revenue requested in this compliance period will cover a project to automate four of the fourteen systems for reporting purposes. Funding to complete the project and tie in the remaining ten systems will be requested in the 2020 compliance plan.

Estimated work for this project includes the following activities:

- Update existing forms
- Modify existing reports
- Integrate changes with other systems
- Gather data
- Application Development and Testing
- Training and Post-Support
- Project and Program Manager time

SoCalGas is also proposing the Engineering Data Analytics and Performance Optimization (EDAPO) system, to provide capabilities to support advanced analytics for Gas Operations & System Integrity and Transmission & Storage. Advanced analytics will provide actionable insights on gas assets' current and future performance. SoCalGas will use EDAPO to predict and help prioritize leak repairs and identify areas with high leak indicators. Results of analytics will become SB 1371 records and will need to be captured and stored in a centralized repository. Advanced analytics will be necessary to manage compliance requirements such as those required by SB 1371. One requirement SB 1371 is the installation of hundreds of new continuous methane sensors throughout the service area along with the required analysis of sensor data in Best Practice 18. The EDAPO Program will implement the tools, infrastructure and resources to drive the improvement of business operations and enable the proactive management of gas assets such as this methane sensor project.

d) Overlap with other regulations? What portion of the BP is incremental beyond those regulations?

There are several regulations that require record keeping. This Best Practice will require records from varying departments be kept in a centralized location in the same units and on the same timeframes so they can be reported in a streamlined way, reducing the labor and manual adjustments to generate the annual emissions reports.

e) What technology is required to implement the best practice and why?

SoCalGas would like to develop two IT systems to meet the requirements of this Best Practice.

SoCalGas is proposing the Engineering Data Analytics and Performance Optimization (EDAPO) system, to provide capabilities to support advanced analytics for Gas Operations & System Integrity and Transmission & Storage. Advanced analytics will provide actionable insights on gas assets' current and future performance. Advanced analytics will be necessary to manage compliance requirements such as those required by SB 1371. The EDAPO Program will implement the tools, infrastructure and resources to drive the improvement of business operations and enable the proactive management of gas assets. All SB 1371 data will be housed in this repository for data analytics.

SoCalGas also proposes developing a centralized database to incorporate SB 1371 records. This will enable automation of reporting. Estimated work for this project includes the following activities:

- Update existing forms
- Modify existing reports
- Integrate changes with other systems
- Gather data
- Application Development and Testing
- Training and Post-Support
- Project and Program Manager time

f) Will work require additional personnel and/or contract support? If so, please provide details.

Eight incremental employees are needed to manage data analytics and develop the system for tracking.

g) What changes to existing operations are required? How will those changes be implemented?

No operational changes are expected. The activities being proposed for this Best Practices are essentially IT projects that will change the way data is recorded and reports are generated. This may result in updated forms and record-keeping activities for employees across the company.

h) What are the new procedures to develop or existing procedures to modify? Please provide details.

New procedures will need to be developed regarding departmental reporting requirements. Accurate reporting of methane emissions and leaks, including estimation methodologies and assumptions, is critical for regulatory compliance. A written company policy is needed so these records are maintained for all SB 1371 emission records. This policy will be generated and stored in SoCalGas' Department Records Retention Schedule with User Records.

i) Timeline for implementation (Milestones):

All milestones are listed as the approximate length of time to completion from the date cost recovery is approved.

- Commission Engineering Data Analytics & Performance Optimization IT project and generate scope of work: 6 months
- Hire and train new employees: 9 months
- Draft and review policy updates: 9 months
- Training development: 9 months
- Complete for software automation project for four systems: 12 months
- Train employees on new reporting requirements: 12 months
- Update IT systems to capture emissions data required by SB 1371, incorporate remaining 10 systems. Development, testing, and reporting: 24 months
- Publish policy changes and implement new reporting policies: 24 months
- Complete and implement Engineering Data Analytics & Performance Optimization IT project and generate scope of work: 36 months

j) Identify the range of factors or considerations used to determine cost-effectiveness of this measure, when costs estimates have been determined:

There is insufficient data to estimate emission reductions from the activities in this Best Practice.

k) Identify any cost benefits from this BP, when cost estimates are known:

Cost benefits for this Best Practice include an anticipated reduction in labor needs. There is insufficient data to quantify those benefits at this time.

l) Do any incremental costs, if known, or benefits overlap with other BPs? If so, to which BP do they overlap, what are they, and how do they overlap?

This Best Practice overlaps with Best Practices 15, 16, 17, 18, 19, 20a, 21, 23, 24, and 26. It creates a centralized system for operational records of methane emissions information to be stored and for operational activities to be coordinated to minimize emissions. The system proposed in Best Practice 26 will also support this activity by combining records from the Company Damage Report System with the Incident Management System.

m) Anticipated Emissions Reductions from this BP:

There is insufficient data to estimate emission reductions from the activities in this Best Practice.

2015 Baseline Emissions affected, where known:

N/A

n) Calculation Methodology: N/A
o) Additional Comments: N/A
p) Overlap with Safety: N/A
SUPPLEMENTAL INFORMATION
a) Technology:
b) Changes to Operations:
c) Research or Studies:
d) Other:

Best Practice 10: Minimize Uncontrolled Natural Gas Emissions Training

2018 LEAK ABATEMENT COMPLIANCE PLAN TEMPLATE (D.17-06-015)

PART 1: OVERVIEW	
a) Best Practice: #10	b) Status: Work pending approval of AL 5211
<p>Minimize Uncontrolled Natural Gas Emissions - Training to ensure that personnel know how to use company emergency procedures which describe the actions staff shall take to prevent, minimize and/or stop the uncontrolled release of natural gas from the gas system or storage facility. Training programs to be designed by the Company and approved by the CPUC, in consultation with CARB, as part of the Compliance Plan filing. If integration of training and program development is required with the company's General Rate Case (GRC) and/or Collective Bargaining Unit (CBC) processes, then the company shall file a draft training program and plan with a process to update the program once finalized into its Compliance.</p>	
PART 2: BEST PRACTICE DETAILS	
a) Historic work:	
<p>Minimization of the uncontrolled release of natural gas emissions and use of company emergency procedures is currently addressed in standard training courses for all operational employees. Training is based on the emergency incident response policies and procedures as stated in Gas Standards 183.03 and 183.0110.</p>	
b) Alternative Proposal to BP or exemption? Yes	
c) Proposed Plan:	
<p>SoCalGas has existing training programs regarding emergency operating procedures that prioritize actions taken during emergency situations. Gas Standards 183.03 and 183.0110 are attached and document the actions taken during this type of situation, with safety as the highest priority. After reviewing Gas Standards 183.03 and 183.0110, SoCalGas did not identify any modifications to emergency procedures or opportunities for emissions reductions, as it could interfere with safety procedures. The intent of SB 1371 was not to deprioritize safety.</p>	
d) Overlap with other regulations? What portion of the BP is incremental beyond those regulations?	
<p>Historically, Gas Operations Training has been driven by a strong emphasis on DOT safety regulations. SB 1371 will require an additional emphasis on the control of emissions. As changes in processes,</p>	

procedures, equipment and technology emerge due to implementation of Best Practices, existing training will need to be modified and new training modules developed.

e) What technology is required to implement the best practice and why?

No technology is needed for this Best Practice

f) Will work require additional personnel and/or contract support? If so, please provide details.

No incremental resources are needed for the activities in this Best Practice.

g) What changes to existing operations are required? How will those changes be implemented?

No changes are required to existing operations.

h) What are the new procedures to develop or existing procedures to modify? Please provide details.

No changes are required to existing procedures. Currently, Gas Operations training follows an established, systematic approach to training development and training conduct consisting of:

- Needs assessment
- Training analysis
- Curriculum design
- Development of training materials
- Implementation of instruction
- Internal/external evaluation.

This process is “content neutral” and is applicable to any changes in the work environment that requires training to be developed or modified.

i) Timeline for implementation (Milestones):

N/A

j) Identify the range of factors or considerations used to determine cost-effectiveness of this measure, when costs estimates have been determined:

There is insufficient data to estimate emission reductions from the activities in this Best Practice.

k) Identify any cost benefits from this BP, when cost estimates are known:

There is insufficient data to estimate cost benefits from the activities in this Best Practice.

l) Do any incremental costs, if known, or benefits overlap with other BPs? If so, to which BP do they overlap, what are they, and how do they overlap?

In Best Practice 13, SoCalGas recommend implementing a competency based training program that will encompass training design for all new methane mitigation policy and procedural changes. SoCalGas currently has a traditional classroom training approach, which requires employees to commute from across the service territory to attend classroom trainings, incurring mileage and hotel expenses. Due to the rate of change of policies, SoCalGas needs a more agile training system that can reflect new policy changes and deploy new content quickly. A competency based online/video training module system would enhance SoCalGas' ability to incorporate new policies and increase learning at a faster pace. This system, which is proposed in Best Practice 13, would support any training associated with this Best Practice.

m) Anticipated Emissions Reductions from this BP:

There is insufficient data to estimate emission reductions from the activities in this Best Practice.

2015 Baseline Emissions affected, where known:

NA

n) Calculation Methodology:

NA

o) Additional Comments:

NA

p) Overlap with Safety:

Gas Standards 183.03 and 183.0110 are attached and document the actions taken during emergencies, with safety as the highest priority. After reviewing Gas Standards 183.03 and 183.0110, SoCalGas did not identify any modifications to emergency procedures or opportunities for emissions reductions, as it could interfere with safety procedures. The intent of SB 1371 was not to deprioritize safety.

SUPPLEMENTAL INFORMATION

a) Technology:

b) Changes to Operations:

c) Research or Studies:

d) Other:

The accompanying attachments have been redacted to remove non-responsive, non-relevant employee and disaster recovery strategy and plan information.

Attachment H: Gas Standard 183.0110

Attachment I: Gas Standard 183.03

Best Practice 11: Methane Emissions Minimization Policies Training

2018 LEAK ABATEMENT COMPLIANCE PLAN TEMPLATE (D.17-06-015)

PART 1: OVERVIEW	
a) Best Practice: #11	b) Status: Work pending approval of AL 5211
<p>Ensure that training programs educate workers as to why it is necessary to minimize methane emissions and abate natural gas leaks. Training programs to be designed by the Company and approved by the CPUC, in consultation with CARB, as part of the Compliance Plan filing. If integration of training and program development is required with the company's GRC and/or CBC processes, then the company shall file a draft training program and plan with a process to update the program once finalized into its Compliance Plan.</p>	
PART 2: BEST PRACTICE DETAILS	
a) Historic work:	
<p>SoCalGas has a robust classroom training program facilitated at a centralized training facility in Pico Rivera. The training facility is equipped with an area known as Situation City where trainees can experience real world emergencies like a blowing high-pressure line with an ignition source, while in a safe and controlled environment. Training programs are focused primarily on DOT PHMSA safety regulations. Safety is a core value at SoCalGas and all current training programs are focused around incorporating safety in all procedures as a primary goal.</p> <p>This traditional classroom training approach requires employees to commute from across the service territory to attend in-person trainings, incurring mileage and hotel expenses. Due to the rate of change of policies, SoCalGas needs a more agile training system that can reflect new policy changes and deploy new content quickly.</p>	
b) Alternative Proposal to BP or exemption? No	
c) Proposed Plan: See Best Practice 13 for proposed plan	
d) Overlap with other regulations? What portion of the BP is incremental beyond those regulations?	
<p>Historically, Gas Operations Training has been driven by a strong emphasis on DOT safety regulations. SB 1371 will require an additional emphasis on the control of emissions. As changes in processes, procedures, equipment, and technology emerge due to implementation of Best Practices, existing training will need to be modified and new training modules developed to support the new process</p>	

and policies. Employee training will require an increased focus on the environmental impact of methane emissions on the atmosphere.

e) What technology is required to implement the best practice and why?

Gas Operations Training trains and Operationally Qualifies employees using the same or very similar equipment as used in the field per ASME B31Q requirements. As the scope of equipment requirements are established to implement SB 1371, Gas Operations Training will require the same equipment and technologies as what is being used in the field.

In Best Practice 13, SoCalGas recommend implementing a competency based training program that will encompass training design for all new methane mitigation policy and procedural changes. Due to the rate of change of policies, SoCalGas needs a more agile training system that can reflect new policy changes deploy new content quickly. A competency based online/video training module system would enhance SoCalGas' ability to incorporate new policies and increase learning at a faster pace. This system, which is proposed in Best Practice 13, would support any training associated with this Best Practice.

f) Will work require additional personnel and/or contract support? If so, please provide details.

No incremental employees have been requested but anticipated incremental time will be needed from existing employees for the following activities:

- 50 hours of training module development consultation, writing – Subject Matter Experts
- 1 Hour of training X 400 employees
- 20 Hours instructor time to conduct training (20 students per class X 20 classes = 400 employees)

g) What changes to existing operations are required? How will those changes be implemented?

No changes are required to existing operations.

h) What are the new procedures to develop or existing procedures to modify? Please provide details.

No changes are required to existing procedures. Currently, Gas Operations training follows an established, systematic approach to training development. The development of training programs at SoCalGas includes needs assessment and training analysis, which is essentially a scope of work development. Based on what is found, curriculum design and development of training materials will follow. In this case, the curriculum design is included in Best Practice 13 for SoCalGas. When development is completed, implementation of instruction and internal/external evaluation begin. This process is “content neutral” and is applicable to any changes in the work environment that requires training to be developed or modified.

i) Timeline for implementation (Milestones):

All milestones are listed as the approximate length of time to completion from the date cost recovery is approved:

- Establish scope of work for training modifications: 1 month
- Instructional Design: 2 months
- Gas Standards reviewed: 2 months
- Development of training materials: 3 months
- Evaluations of training materials and train-the-trainer: 6 months
- Training Implementation: 6-12 months

j) Identify the range of factors or considerations used to determine cost-effectiveness of this measure, when costs estimates have been determined:

There is insufficient data to quantify emission reductions from the activities in this Best Practice.

k) Identify any cost benefits from this BP, when cost estimates are known:

All applicable cost benefits from a centralized curriculum design are captured in Best Practice 13.

l) Do any incremental costs, if known, or benefits overlap with other BPs? If so, to which BP do they overlap, what are they, and how do they overlap?

This training will incorporate policy changes in Best Practices 3-7 and operational changes in Best Practices 15-25.

In Best Practice 13, SoCalGas recommend implementing a competency based training program that will encompass training design for all new methane mitigation policy and procedural changes. This system, which is proposed in Best Practice 13, would support any training design associated with this Best Practice.

m) Anticipated Emissions Reductions from this BP:

There is insufficient data to quantify emission reductions from the activities in this Best Practice.

2015 Baseline Emissions affected, where known:

N/A

n) Calculation Methodology:

N/A

o) Additional Comments:

NA

p) Overlap with Safety:

Preventing, minimizing and/or stopping the uncontrolled release of natural gas is integral to safety. The two topics will be addressed in training in tandem.

SUPPLEMENTAL INFORMATION

a) Technology:

b) Changes to Operations:

c) Research or Studies:

d) Other:

Best Practice 12: Knowledge Continuity Training Programs

2018 LEAK ABATEMENT COMPLIANCE PLAN TEMPLATE (D.17-06-015)

PART 1: OVERVIEW	
a) Best Practice: #12	b) Status: Work pending approval of AL 5211
<p>Knowledge Continuity Training Programs - Knowledge Continuity (transfer) Training Programs to ensure knowledge continuity for new methane emissions reductions best practices as workers, including contractors, leave and new workers are hired. Knowledge continuity training programs to be designed by the Company and approved by the CPUC, in consultation with CARB, as part of the Compliance Plan filing. If integration of training and program development is required with the company's GRC and/or CBC processes, then the company shall file a draft training program and plan with a process to update the program once finalized into its Compliance Plan.</p>	
PART 2: BEST PRACTICE DETAILS	
a) Historic work:	
<p>SoCalGas has a robust classroom training program facilitated at a centralized training facility in Pico Rivera. The training facility is equipped with an area known as Situation City where trainees can experience real world emergencies like a blowing high-pressure line with an ignition source, while in a safe and controlled environment. Training programs are focused primarily on DOT PHMSA safety regulations. Safety is a core value at SoCalGas and all current training programs are focused around incorporating safety in all procedures as a primary goal.</p> <p>SoCalGas is very focused on knowledge management and encourages leadership at all levels to focus on activities to increase knowledge transfer within their organization. SoCalGas employs several mentoring programs, cross-departmental knowledge transfer activities, and process records to encourage knowledge management and knowledge transfer processes.</p>	
b) Alternative Proposal to BP or exemption? No	
c) Proposed Plan:	
<p>SoCalGas proposes implementing a competency based training module with a focus on knowledge management and operational practices to minimize methane emissions.</p>	
d) Overlap with other regulations? What portion of the BP is incremental beyond those regulations?	
<p>Historically, Gas Operations Training has been driven by a strong emphasis on DOT safety regulations. SB 1371 will require an additional emphasis on the control of emissions. As changes in processes,</p>	

procedures, equipment, and technology emerge due to implementation of Best Practices, existing training will need to be modified and new training modules developed to support the new process and policies. Employees will be trained with an increased focus on the environmental impact of methane emissions on the atmosphere.

e) What technology is required to implement the best practice and why?

Gas Operations Training trains and Operationally Qualifies employees using the same or very similar equipment as used in the field per ASME B31Q requirements. As the scope of equipment requirements are established to implement SB 1371, Gas Operations Training will require the same equipment and technologies as in the field.

In Best Practice 13, SoCalGas recommend implementing a competency based training program that will encompass training design for all new methane mitigation policy and procedural changes. Due to the rate of change of policies, SoCalGas needs a more agile training system that can reflect new policy changes and deploy new content quickly. A competency based online/video training module system would enhance SoCalGas' ability to incorporate new policies and increase learning at a faster pace. This system, which is proposed in Best Practice 13, would support any training associated with this Best Practice. SoCalGas believes this will also support knowledge management. Training will be managed with a shorter turnaround and with less impact to business and at a lower cost of training implementation.

f) Will work require additional personnel and/or contract support? If so, please provide details.

No incremental employees have been requested but anticipated incremental time will be needed from existing employees for the following activities:

- 20 hours of work by agency instructional designer. Development of visual aids, handouts, course materials, tests.
- 1 Hour of training X 400 employees
- 20 Hours instructor time to conduct training (20 students per class X 20 classes = 400 employees)

g) What changes to existing operations are required? How will those changes be implemented?

No changes are required to existing operations.

h) What are the new procedures to develop or existing procedures to modify? Please provide details.

No changes are required to existing procedures. Currently, Gas Operations training follows an established, systematic approach to training development. The development of training programs at SoCalGas includes needs assessment and training analysis, which is essentially a scope of work development. Based on what is found, curriculum design and development of training materials will

follow. In this case, the curriculum design is included in Best Practice 13 for SoCalGas. When development is completed, implementation of instruction and internal/external evaluation begin. This process is “content neutral” and is applicable to any changes in the work environment that requires training to be developed or modified.

i) Timeline for implementation (Milestones):

All milestones are listed as the approximate length of time to completion from the date cost recovery is approved:

- Establish scope of work for training modifications: 1 month
- Instructional Design: 2 months
- Development of training materials: 3 months
- Evaluations of training materials and train-the-trainer: 6 months
- Training Implementation: 6-12 months

j) Identify the range of factors or considerations used to determine cost-effectiveness of this measure, when costs estimates have been determined:

There is insufficient data to estimate emission reductions from the activities in this Best Practice.

k) Identify any cost benefits from this BP, when cost estimates are known:

All applicable cost benefits from a centralized curriculum design are captured in Best Practice 13.

l) Do any incremental costs, if known, or benefits overlap with other BPs? If so, to which BP do they overlap, what are they, and how do they overlap?

This training will incorporate policy changes in Best Practices 3-7 and operational changes in Best Practices 15-25.

In Best Practice 13, SoCalGas recommend implementing a competency based training program that will encompass training design for all new methane mitigation policy and procedural changes. Due to the rate of change of policies, SoCalGas needs a more agile training system that can reflect new policy changes deploy new content quickly. A competency based online/video training module system would enhance SoCalGas’ ability to incorporate new policies and increase learning at a faster pace. This system, which is proposed in Best Practice 13, would support any training design associated with this Best Practice.

m) Anticipated Emissions Reductions from this BP:

There is insufficient data to estimate emission reductions from the activities in this Best Practice.

2015 Baseline Emissions affected, where known:

N/A

n) Calculation Methodology: NA
o) Additional Comments: NA
p) Overlap with Safety: Preventing, minimizing and/or stopping the uncontrolled release of natural gas is integral to safety. The two topics will be addressed in training in tandem.
SUPPLEMENTAL INFORMATION
a) Technology:
b) Changes to Operations:
c) Research or Studies:
d) Other:

Best Practice 13: Performance Focused Training Program

2018 LEAK ABATEMENT COMPLIANCE PLAN TEMPLATE (D.17-06-015)

PART 1: OVERVIEW	
a) Best Practice: #13	b) Status: Work pending approval of AL 5211
<p>Performance Focused Training Programs - Create and implement training programs to instruct workers, including contractors, on how to perform the BPs chosen, efficiently and safely. Training programs to be designed by the Company and approved by the CPUC, in consultation with CARB, as part of the Compliance Plan filing. If integration of training and program development is required with the company's GRC and/or CBC processes, then the company shall file a draft training program and plan with a process to update the program once finalized into its Compliance Plan.</p>	
PART 2: BEST PRACTICE DETAILS	
a) Historic work:	
<p>SoCalGas has a robust classroom training program facilitated at a centralized training facility in Pico Rivera. The training facility is equipped with an area known as Situation City where trainees can experience real world emergencies like a blowing high-pressure line with an ignition source, while in a safe and controlled environment. Training programs are focused primarily on DOT PHMSA safety regulations. Safety is a core value at SoCalGas and all current training programs are focused around incorporating safety in all procedures as a primary goal.</p> <p>Gas Operations training follows an established, systematic approach to training development. The development of training programs at SoCalGas includes needs assessment and training analysis, which is essentially a scope of work development. Based on what is found, curriculum design and development of training materials will follow. When development is completed, implementation of instruction and internal/external evaluation begin. This process is "content neutral" and is applicable to any changes in the work environment that requires training to be developed or modified.</p> <p>SoCalGas is very focused on knowledge management and encourages leadership at all levels to focus on activities to increase knowledge transfer within their organization. SoCalGas employs several mentoring programs, cross-departmental knowledge transfer activities, and process records to encourage knowledge management and knowledge transfer processes.</p>	
b) Alternative Proposal to BP or exemption? No	
c) Proposed Plan:	

SoCalGas recommends implementing a competency based training program that will encompass training design for all new methane mitigation policy and procedural changes. SoCalGas currently has a traditional classroom training approach, which requires employees to commute from across the service territory to attend classroom trainings, incurring mileage and hotel expenses. Due to the rate of change of policies, SoCalGas needs a more agile training system that can reflect new policy changes deploy new content quickly. A competency based online/video training module system would enhance SoCalGas' ability to incorporate new policies and increase learning at a faster pace. This system also supports training design needs associated with Best Practices 11-12. SoCalGas believes this will also support knowledge management, as training will be managed with a shorter turnaround, reducing impact to business and cost of training implementation.

As new processes, procedures, and policies emerge due to SB 1371, they will be incorporated into existing training. SoCalGas proposes converting its traditional classroom training approach to a comprehensive, multimedia, competency-based training approach which will include self-paced, individualized, modular instruction, eLearning, just-in-time training, structured on-the-job training and mentoring.

d) Overlap with other regulations? What portion of the BP is incremental beyond those regulations?

Historically, Gas Operations Training has been driven by a strong emphasis on DOT safety regulations. SB 1371 will require an additional emphasis on the control of emissions. As changes in processes, procedures, equipment, and technology emerge due to implementation of Best Practices, existing training will need to be modified and new training modules developed to support the new process and policies. Employees will be trained with an increased focus on the environmental impact of methane emissions on the atmosphere.

e) What technology is required to implement the best practice and why?

Gas Operations Training trains and Operationally Qualifies trainees using the same or very similar equipment as used in the field per ASME B31Q requirements. As the scope of equipment requirements are established to implement AB1371, Gas Operations Training will require the same equipment and technologies as in the field.

SoCalGas recommends implementing a competency based training program that will encompass training design for all new methane mitigation policy and procedural changes. Due to the rate of change of policies, SoCalGas needs a more agile training system that can reflect new policy changes deploy new content quickly. A competency based online/video training module system would enhance SoCalGas' ability to incorporate new policies and increase learning at a faster pace. This system also support training design needs associated with Best Practices 11-12 using a comprehensive, multimedia, competency-based training approach which will include self-paced, individualized, modular instruction, eLearning, just-in-time training, structured on-the-job training and mentoring.

f) Will work require additional personnel and/or contract support? If so, please provide details.

A vendor will be selected for a train-the-train program to help transition to the new training approach.

A media production vendor will be engaged to convert significant portions of the Gas Operations Training curriculum to eLearning.

This effort will require involvement of a Team Lead (40%), three Instructional Designers (100%), and three Instructors (30%) each for 18 months.

Anticipated incremental time will be needed from existing employees for the following activities:

- 20 hours of work by agency instructional designer. Development of visual aids, handouts, course materials, tests.
- 1 Hour of training X 400 employees
- 20 Hours instructor time to conduct training (20 students per class X 20 classes = 400 employees)

g) What changes to existing operations are required? How will those changes be implemented?

Changes to Gas Operations Training department operations will be significant. Instead of scheduling classes that start and end on specific dates on a calendar, training will be offered in a flexible, ongoing format. The individualized instruction environment will allow students to begin training anytime and training will conclude when the student has achieved competence. The role of the instructor will change from the primary dispenser of instructional content to a facilitator of learning. Interactive, media-rich training materials will be the primary channel for students to learn training content as opposed to the current traditional classroom format. The instructor's role will transition to coaching, mentoring, and observing hands-on activities performed by students. This new training format is expected to increase the speed of competence development.

h) What are the new procedures to develop or existing procedures to modify? Please provide details.

New training procedures will need to be developed as the new training formats become available.

i) Timeline for implementation (Milestones):

All milestones are listed as the approximate length of time to completion from the date cost recovery is approved.

- Vendor selection: 1 month
- Establish scope of work for training modifications: 3 months
- Leadership to complete train-the-trainer seminars: 6 months
- Instructional Design: 18 months
- Development of training materials: 18 months

<ul style="list-style-type: none"> • Evaluations of training materials and train-the-trainer: 24 months • Training Implementation: 18-24 months
<p>j) Identify the range of factors or considerations used to determine cost-effectiveness of this measure, when costs estimates have been determined:</p> <p>There is insufficient data to estimate emission reductions from the activities in this Best Practice.</p>
<p>k) Identify any cost benefits from this BP, when cost estimates are known:</p> <p>Cost benefits expected from this activity will include reduced mileage expenses, reduced employee time in training, and reduced hoteling expenses. SoCalGas won't be able to quantify these amounts until there is a clear scope of work, which will be developed after cost recovery is approved to move forward. A very rough estimate of savings is estimated at \$400,000 per year.</p>
<p>l) Do any incremental costs, if known, or benefits overlap with other BPs? If so, to which BP do they overlap, what are they, and how do they overlap?</p> <p>This training will incorporate policy changes in Best Practices 3-7 and operational changes in Best Practices 15-25.</p> <p>The competency based training program proposed in this Best Practice will encompass training design for all new methane mitigation policy and procedural changes. This system would support any training design associated with Best Practices 10-12.</p>
<p>m) Anticipated Emissions Reductions from this BP:</p> <p>There is insufficient data to estimate emission reductions from the activities in this Best Practice.</p> <p>2015 Baseline Emissions affected, where known:</p> <p>N/A</p>
<p>n) Calculation Methodology:</p> <p>NA</p>
<p>o) Additional Comments:</p> <p>NA</p>
<p>p) Overlap with Safety:</p> <p>Preventing, minimizing and/or stopping the uncontrolled release of natural gas is integral to safety. The two topics will be addressed in training in tandem.</p>
<p>SUPPLEMENTAL INFORMATION</p>

a) Technology:
b) Changes to Operations:
c) Research or Studies:
d) Other:

Best Practice 14: Experienced, Trained Personnel

2018 LEAK ABATEMENT COMPLIANCE PLAN TEMPLATE (D.17-06-015)

PART 1: OVERVIEW	
a) Best Practice: #14	b) Status: Work pending approval of AL 5211
<p>Create new formal job classifications for apprentices, journeyman, specialists, etc., where needed to address new methane emissions minimization and leak abatement best practices, and filed as part of the Compliance Plan filing, to be approved by the CPUC, in consultation with CARB.</p>	
PART 2: BEST PRACTICE DETAILS	
a) Historic work:	
<p>SoCalGas has proactively used internal policies and procedures that require operations to take measures to minimize methane emissions during venting. For example, Gas Standard 223.0145, Planning Shutdowns for Transmission and Storage, states: “Plan to minimize gas blown to atmosphere through the use of Distribution facilities to reduce gas pipeline inventory.”</p> <p>SoCalGas became a founding member of The EPA Natural Gas STAR Program in 1993. Through this program, SoCalGas has implemented methane reducing technologies and practices and documented voluntary emission reduction activities. SoCalGas continuously evaluates methane emission reduction opportunities, implements cost-effective methane reduction projects where feasible, and annually reports methane emission reduction actions to the EPA. Total savings by SoCalGas through implementation of methane reduction practices between 1993 and 2016 were 2,620,910,000 cubic feet of methane.</p> <p>SoCalGas has long recognized the need to voluntarily reduce methane emissions. The company has contributed to the elimination of methane emissions by employing several different best practices, including:</p> <ul style="list-style-type: none"> • <u>Directed Inspection & Maintenance (DI&M)</u>; A DI&M program concentrates on components that are prone to leak enough methane to make repairs cost-effective. Such components include valve packing, pneumatic controllers and open-ended lines such as vent and drain connections, blowdown lines, pneumatic engine starter motors, and pressure relief valves.⁴⁸ • <u>Identify and rehabilitate leaky distribution pipe</u>; Through regular leak surveys, SoCalGas has identified and repaired or replaced pipeline that with high leak rates. • <u>Replace compressor rod packing systems</u>; Reciprocating compressors in the natural gas industry leak natural gas during normal operation. Areas of high leak frequency include flanges, valves, and fittings located on compressors. The highest volume of gas loss, however, 	

⁴⁸ “Conduct Directed Inspection and Maintenance at Remote Sites.” *EPA.gov*, 2011, www.epa.gov/natural-gas-star-program/conduct-directed-inspection-and-maintenance-remote-sites.

is associated with piston rod packing systems. Packing systems are used to maintain a tight seal around the piston rod, preventing the gas compressed to high pressure in the compressor cylinder from leaking, while allowing the rod to move freely. Compressor rod packing consists of a series of flexible rings that fit around the shaft to create a seal against leakage. Packing rings are held in place by a set of packing cups, normally one for each pair of rings, and kept tight against the shaft by a surrounding spring. A “nose gasket” on the end of the packing case prevents leaks around the packing cups. Leaking gases are vented to the atmosphere through packing vents on the flange. Leakage can be reduced through proper monitoring and a cost-effective schedule for replacing packing rings and piston rods. New ring materials and new designs for packing cases are emerging that should reduce emissions in the future.⁴⁹

- Reduce system pressure for maintenance blowdowns; Operators of natural gas pipeline systems routinely reduce line pressure and discharge gas from pipeline sections to provide safe working conditions during maintenance and repair activities. Typically, operators block the smallest possible linear section of the pipeline and depressurize it by venting gas to the atmosphere. Using pump-down techniques to lower gas line pressure before performing maintenance and repair activities is an effective way to reduce emissions and yield significant economic savings. Pipeline pump-down techniques involve using in-line compressors either alone or in sequence with portable compressors. Using in-line compressors is almost always justifiable because there are no capital costs, and payback is immediate. The cost-effectiveness of also using a portable compressor to increase gas recovery, however, depends greatly on site-specific factors and operating costs. Regardless of the pump-down technique selected, emission reductions are directly proportional to how much pipeline pressure is reduced before venting occurs. Pipeline pump-down techniques are most economical for larger volume, higher pressure gas lines and work most effectively for planned maintenance activities and cases in which sufficient manifolding exists to connect a portable compressor.⁵⁰
- Redesign blowdown process in Emergency Shutdown practices; Compressors are used throughout the natural gas industry to move natural gas from production and processing sites to customer distribution systems. Compressors must periodically be taken off-line for maintenance, operational stand-by, or emergency shut down testing, and as a result, methane may be released to the atmosphere from a number of sources. When compressor units are shut down, typically the high pressure gas remaining within the compressors and associated piping between isolation valves is vented to the atmosphere (‘blowdown’) or to a flare. In addition to blowdown emissions, a depressurized system may continue to leak gas from faulty or improperly sealed unit isolation valves. Simple changes in operating practices and in the design of blowdown systems can save money and significantly reduce methane blowdown valve and from reciprocating compressor rod packing, total emissions can be significantly reduced. Four options for reducing emissions when taking compressors off-line are discussed in this paper. These include:
 - Keeping compressors pressurized when off-line.
 - Connecting blowdown vent lines to the fuel gas system and recovering all, or a portion, of the vented gas to the fuel gas system.

⁴⁹ “Reducing Methane Emissions From Rod Packing Systems.” *EPA.gov*, Natural Gas Star Partners, Oct. 2006, www.epa.gov/sites/production/files/2016-06/documents/ll_rodpack.pdf.

⁵⁰ “Using Pipeline Pump-Down Techniques.” *Environmental Protection Agency*, Natural Gas STAR Partners, Oct. 2006. https://www.epa.gov/sites/production/files/2016-06/documents/ll_pipeline.pdf

- Installing static seals on compressor rod packing.
- Installing ejectors on compressor blowdown vent lines.

Keeping compressors fully pressurized when off-line achieves immediate payback—there are no capital costs and emissions are avoided by reducing the net leakage rate. Routing blowdown vent lines to the fuel gas system or to a lower pressure gas line reduces fuel costs for the compressor or other facility equipment, in addition to avoiding blowdown emissions. Static seals installed on compression rods eliminate gas leaking back through the rod packing while a compressor is shutdown under pressure. An ejector uses the discharge of an adjacent compressor as motive to pump blowdown or leaked gas from a shut down compressor into the suction of an operating compressor or a fuel gas system. Benefits of these practices include fewer bulk gas releases, lower leak rates, and lower fuel costs, with a payback in most cases of less than a year.⁵¹

In addition to SoCalGas' work to reduce emissions through the EPA Natural Gas STAR program, corporate policy has historically supported minimizing emissions and protecting environmental resources. Excerpts from the Sempra Corporate Responsibility report make the following references in relation to methane emissions:

- “Not all greenhouse gases have the same impact on the environment. For example, one unit of methane has approximately 25 times the impact of one unit of carbon dioxide.” (page 26)
- “Since the company joined the Natural Gas Star program in 1993, SoCalGas has implemented practices that have resulted in the reduction of more than 800,000 metric tons of CO₂e, the equivalent of removing 169,000 cars from the road for a year. As a result of these efforts, SoCalGas has one of the lowest methane emission rates of natural gas utilities in the U.S.” (page 32)
- “Fugitive emissions (natural gas/methane emissions from leaks or other types of unintended or irregular releases) are our second most significant type of greenhouse gas emissions, behind emissions from stationary combustion. In 2016, fugitive emissions accounted for 94 percent of our methane emissions.” (page 32)⁵²
- Additional information on methane emissions can be found in the link below
 - SoCalGas Methane: <https://www.socalgas.com/stay-safe/methane-emissions>

The Sempra Environmental Policy also supports methane emission reduction, and states “Implement environmental practices where possible and economically prudent, including water reuse and conservation, recycling and waste minimization, greenhouse gas and other air emissions reductions,

⁵¹ “Reducing Emissions When Taking Compressors Off-Line.” *Environmental Protection Agency*, Natural Gas STAR Partners, Oct. 2006, www.epa.gov/sites/production/files/2016-06/documents/ll_compressoroffline.pdf.

⁵² “2016 Corporate Responsibility Report.” *Sempra Energy*, 15 June 2017, www.sempra.com/sustainability/2016-corporate-responsibility-report.

air quality improvements, and the adoption of building and facility standards;”⁵³ A copy of the Sempra Environmental Policy is attached.

Several company procedures and gas standards are in place to mitigate methane emissions, as well as regulations from other governing bodies, such as Pipeline and Hazardous Materials Safety Administration (PHMSA) and Division of Oil, Gas, and Geothermal Resources (DOGGR).

b) Alternative Proposal to BP or exemption? Yes

c) Proposed Plan:

SoCalGas has existing policies, procedures, and trainings that address methane emission reduction. After reviewing existing job profiles, SoCalGas did not identify any needs to change job profiles.

d) Overlap with other regulations? What portion of the BP is incremental beyond those regulations?

N/A

e) What technology is required to implement the best practice and why?

N/A

f) Will work require additional personnel and/or contract support? If so, please provide details.

N/A

g) What changes to existing operations are required? How will those changes be implemented?

N/A

h) What are the new procedures to develop or existing procedures to modify? Please provide details.

N/A

i) Timeline for implementation (Milestones):

N/A

j) Identify the range of factors or considerations used to determine cost-effectiveness of this measure, when costs estimates have been determined:

There is insufficient data to estimate emissions reductions from activities in this Best Practice.

⁵³ “Environmental Policy.” *Sempra Energy*, 1 Dec. 2017, www.sempra.com/sites/default/files/content/files/node-page/file-list/2017/environmental-policy-2017.pdf.

<p>k) Identify any cost benefits from this BP, when cost estimates are known:</p> <p>There is insufficient data to estimate cost benefits from activities in this Best Practice.</p>
<p>l) Do any incremental costs, if known, or benefits overlap with other BPs? If so, to which BP do they overlap, what are they, and how do they overlap?</p> <p>N/A</p>
<p>m) Anticipated Emissions Reductions from this BP:</p> <p>There is insufficient data to estimate emissions reductions from activities in this Best Practice.</p> <p>2015 Baseline Emissions affected, where known:</p> <p>N/A</p>
<p>n) Calculation Methodology:</p> <p>N/A</p>
<p>o) Additional Comments:</p> <p>N/A</p>
<p>p) Overlap with Safety:</p> <p>N/A</p>
<p>SUPPLEMENTAL INFORMATION</p>
<p>a) Technology:</p>
<p>b) Changes to Operations:</p>
<p>c) Research or Studies:</p>
<p>d) Other:</p>

Best Practice 15: Gas Distribution Leak Surveys

2018 LEAK ABATEMENT COMPLIANCE PLAN TEMPLATE (D.17-06-015)

PART 1: OVERVIEW	
a) Best Practice: #15	b) Status: Work pending approval of AL 5211
<p>Utilities should conduct leak surveys of the gas distribution system every 3 years, not to exceed 39 months, in areas where G.O. 112-F, or its successors, requires surveying every 5 years. In lieu of a system-wide three-year leak survey cycle, utilities may propose and justify in their Compliance Plan filings, subject to Commission approval, a risk-assessment based, more cost-effective methodology for conducting gas distribution pipeline leak surveys at a less frequent interval. However, utilities shall always meet the minimum requirements of G.O. 112-F, and its successors.</p>	
PART 2: BEST PRACTICE DETAILS	
a) Historic work: <p>Leak surveys on distribution lines are performed according to the requirements in 49 CFR 192.723 for safety. Labor and non-labor expenses related to surveying the gas distribution system for leaks has historically been requested through the General Rate Case Application. SoCalGas pipelines are typically leak surveyed at intervals of one, three, or five years. The frequency of this survey is determined by, among other things, the pipe material involved (i.e. plastic or steel), the operating pressure, whether the pipe is under cathodic protection, identified threats such as geological hazards, leak history, and the proximity of the pipe to various population densities. In the 2019 General Rate Case, SoCalGas is requesting cost recovery to increase the survey cycle for all Pre-1986 Aldyl-A or Non-State-of-the-Art Plastic (NSOTA) pipe from 5-year to annual for pipeline safety and integrity reasons, which has a co-benefit of emission reductions.</p>	
b) Alternative Proposal to BP or exemption? Yes	
c) Proposed Plan: <p>SoCalGas is proposing an alternative to performing all leak surveys on a minimum three-year survey cycle. The recommended alternative is moving unprotected steel pipe from three-year and NSOTA plastic from five-year to annual cycles⁵⁴ and keeping state-of-the-art (SOTA) plastic and high performing protected steel on a five-year leak survey interval. Incremental leak surveys on unprotected steel and NSOTA plastic is more cost-effective than increased surveys on SOTA plastic and protected steel, as shown in the table below.</p>	

⁵⁴ Revenue recovery for the accelerated leak survey of NSOTA Plastic pipe is being requested in the 2019 General Rate Case Application.

Table 1: Cost-effectiveness of Leak Surveys

Pipe Classification	Unprotected Steel (3-to-1-year surveys)	STOTA Plastic (5-to-3-year surveys)	Protected Steel (5-to-3-year surveys)
Cost-Effectiveness (\$/MCF)	\$34	\$421	\$611

To further illustrate the advantages of this alternative strategy, below are pie charts that clearly show that SoCalGas currently spends 63% of its time performing leak surveys on pipe (Protected Steel 33% + SOTA Plastic 30%) that contributes only 12% of the emissions (Protected Steel 3% + SOTA Plastic 9%).



Moving all classes of pipe to minimum three year survey cycles as suggested in this Best Practice actually intensifies the issue, so that approximately 65% of leak surveys are performed on pipe that is contributing only and estimated 10% of the emissions.



As shown in the charts below, SoCalGas' alternative proposal to Best Practice 15, results in approximately 47% of leak surveys being performed on pipe that is contributing an estimated 22% of emissions. SoCalGas' alternative proposal invests more time surveying pipe with higher leak rates,

resulting in an increased emission reduction. In summary, emission reduction is achieved through detecting and repairing more leaks sooner in their life cycle.



d) Overlap with other regulations? What portion of the BP is incremental beyond those regulations?

Leak surveys on distribution lines are performed according to the requirements in 49 CFR 192.723 for safety. The leak surveys recorded for this Best Practice are incremental to those currently performed for safety reasons.

e) What technology is required to implement the best practice and why?

Software changes to update work management and geographical information systems (SAP and GIS).

Each incremental field leak survey and quality assurance (QA) employee will require leak survey equipment and a company vehicle. The incremental supervisors will also need company vehicles.

f) Will work require additional personnel and/or contract support? If so, please provide details.

To perform the required incremental work, SoCalGas is requesting 12 incremental field leak survey FTEs, four incremental leak survey office employees, three incremental leak survey supervisors, and three incremental QA employees. The field employees are specific to this best practice but the supervisors, office employees, and QA employees will support both this Best Practice and Best Practice 16.

g) What changes to existing operations are required? How will those changes be implemented?

Changes to how leak surveys will be performed are captured in Best Practice 20B, using new technology required for leak surveyors to geographically track their work. Changes captured in this Best Practice only cover the frequency in which the leak surveys will be performed. Those changes will be implemented by hiring and training new employees, updating software systems to meet compliance needs by changing requirements in SAP and GIS, and performing the incremental leak surveys.

h) What are the new procedures to develop or existing procedures to modify? Please provide details.

Gas standards will need to be updated to reflect the increased leak survey intervals required by this best practice. Redlined gas standards 184.0005 and 223.0100 are attached. Updates to these documents are based on the proposed alternative and may require further updates based on decisions regarding implementation of this Best Practice.

i) Timeline for implementation (Milestones):

All milestones are listed as the approximate length of time to completion from the date cost recovery is approved.

- SAP/GIS updates: 3 months
- Equipment purchased and received: 6 months
- Policy review: 2 months
- Training development: 3-6 months
- Hiring and training new employees: 6-12 months
- Training of existing field employees: 6-12 months
- Publishing policy changes: 12 months
- Full implementation: 12 months

j) Identify the range of factors or considerations used to determine cost-effectiveness of this measure, when costs estimates have been determined:

Cost-effectiveness evaluations were generated by calculating the cumulative revenue requirement for activities that directly contribute to emissions reductions. The activity costs used to calculate the revenue requirement include the fully loaded and escalated capital investment and associated O&M, including on-going O&M over the useful life of the related capital asset, if applicable. The cumulative revenue requirement was divided by the total years of useful life to generate an average annual revenue requirement. Multiplying this annual average revenue requirement by 12 gives the estimated total cost of implementation for the SB 1371 program from 2018 through 2030.

Annual emissions reductions were compounded and summed to generate a total emissions reduction over the twelve-year program period.

Cost benefits were evaluated at the forecasted average annual WACOG published in the 2016 California Gas Report, converted to cost per MCF using a BTU conversion factor of 1.0343.

Cost-effectiveness is generated by dividing the cost of implementation less any cost benefits by estimated emission reduction.

The cost-effectiveness evaluations apply to moving leak surveys from five-year to three-year cycles as required by this Best Practice. The cost-effectiveness evaluation of the alternative is provided in Best Practice 16, which evaluates the annual cycles for unprotected steel, and is calculated at \$34/MCF.

Cost-Effectiveness for Three-Year Cycles on SOTA Plastic and Protected Steel

The average annual revenue requirement for this Best Practice is \$7,632,459. Over the twelve-year period, 2018-2030, the revenue requirement is estimated to be \$91,589,508.

Cost Benefits over the period from 2018-2030 are estimated at \$806,510. Details are in section K.

The compounded emissions reductions from 2018-2030 for moving state of the art plastic and protected steel to three-year survey cycles are estimated at 193,106 MCF. Details are in section M.

Overall cost-effectiveness = $(\$91,589,508 - \$806,510) / 193,106 \text{ MCF} = \$470/\text{MCF}$

In addition to evaluating the cost-effectiveness of the Best Practice as a whole, the cost-effectiveness was broken down by each class of pipe to determine which surveys were more cost-effective.

Reductions resulting from Aldyl-A were not incorporated in cost-effectiveness because funding for that was requested through the GRC, not through the SB 1371 program. To calculate the breakdown of cost-effectiveness by pipe class, the annual average revenue was prorated by incremental miles surveyed by pipeline class.

Cost-Effectiveness for State of the Art Plastic Pipe

State of the Art Plastic Pipe represents 67% of the incremental surveys covered by this Best Practice.

The prorated average annual revenue requirement for this Best Practice is \$5,089,012. Over the twelve-year period, 2018-2030, the revenue requirement is estimated to be \$61,068,144.

Cost Benefits over the period from 2019-2030 are estimated at \$598,041.

The compounded emissions reductions from 2019-2030 for moving state of the art plastic to three-year survey cycles are estimated at 143,495 MCF.

Overall cost-effectiveness = $(\$61,068,144 - \$598,041) / 143,495 \text{ MCF} = \$421/\text{MCF}$

Cost-Effectiveness for Cathodically Protected Steel Pipe

Cathodically Protected Steel Pipe represents 33% of the incremental surveys covered by this Best Practice.

The prorated average annual revenue requirement for this Best Practice is \$2,543,447. Over the twelve-year period, 2018-2030, the revenue requirement is estimated to be \$30,521,364.

Cost Benefits over the period from 2018-2030 are estimated at \$208,470.

The compounded emissions reductions from 2018-2030 for moving protected steel to three-year survey cycles are estimated at 49,610 MCF.

Overall cost-effectiveness = $(\$30,521,364 - \$208,470) / 49,610 \text{ MCF} = \$611/\text{MCF}$

k) Identify any cost benefits from this BP, when cost estimates are known:

Cost benefits include the cost of gas saved by reducing emissions, estimated at \$806,510 over 2018-2030. Cost benefits were evaluated at the forecasted average annual Weighted Average Cost of Gas (WACOG) published in the 2016 California Gas Report, converted to cost per MCF using a BTU conversion factor of 1.0343.

Year	WACOG (\$/MCF)	Reduced Emissions	Cost Benefits
2019	\$2.664188	3,390	\$9,031
2020	\$2.649745	8,677	\$22,991
2021	\$2.986593	13,270	\$39,634
2022	\$3.475680	17,612	\$61,214
2023	\$3.743690	18,770	\$70,268
2024	\$3.952100	18,770	\$74,179
2025	\$4.224613	18,770	\$79,294
2026	\$4.525677	18,770	\$84,945
2027	\$4.624728	18,770	\$86,804
2028	\$4.734834	18,770	\$88,871
2029	\$4.944888	18,770	\$92,813
2030	\$5.139493	18,770	\$96,466

l) Do any incremental costs, if known, or benefits overlap with other BPs? If so, to which BP do they overlap, what are they, and how do they overlap?

The incremental supervisors, office employees, and quality assurance (QA) employees requested in this best practice will also be used for the work proposed in Best Practice 16. The system upgrades required for this work will also be used to cover the system upgrades needed for Best Practice 16.

m) Anticipated Emissions Reductions from this BP:

Assumption is all leaks will be repaired within 6 months after discovery, which is SoCalGas' current system leak repair average for plastic pipe. The gas standards require leaks on plastic pipe to be repaired within 15 months. The emissions reduction expected to be achieved by moving all leak surveys from 5-year to three-year intervals is expected to provide a compounded reduction of 193,106 MCF over the period of 2018-2030. Details of expected emissions reductions can be found in the tables below.

Scenario	Emissions [MCF]						
	2016 Baseline	Yr 1	Yr 2	Yr 3	Yr 4	Yr 5	Yr 6
Non-State of the Art Plastic (Pre-86 Aldyl A) Pipe from 5Yr to 1Yr	154,695	137,946	87,115	58,539	58,515	58,515	58,515
Cathodically Protected Steel from 5Yr to 3Yr	15,554	15,161	13,841	11,871	10,892	10,659	10,659
State of the Art Plastic from 5Yr to 3 Yr	44,126	41,129	37,162	34,538	31,175	30,252	30,252
Unprotected Steel -Continue at 3Yr	15,554	15,554	15,554	15,554	15,554	15,554	15,554

Year	Year-of emissions reductions (MCF)	Compounded Emissions Reductions (MCF)
2019	3,390	3,390
2020	8,677	12,066
2021	13,270	25,337
2022	17,612	42,949
2023	18,770	61,719
2024	18,770	80,488
2025	18,770	99,258
2026	18,770	118,027
2027	18,770	136,797
2028	18,770	155,566
2029	18,770	174,336
2030	18,770	193,106

There are additional emission reductions achieved through the increased leak surveys on Pre-1986 Aldyl A Plastic pipe, from 5-year to annual cycles. Estimated emissions compounded over 2018-2030 are estimated at 1,046,095. Details of expected emissions reductions can be found in the table below.

Year	Year-of emissions reductions (MCF)	Compounded Emissions Reductions (MCF)
2019	16,749	16,749
2020	67,580	84,329
2021	96,155	180,484
2022	96,179	276,663
2023	96,179	372,842
2024	96,179	469,021
2025	96,179	565,200
2026	96,179	661,379
2027	96,179	757,558
2028	96,179	853,737
2029	96,179	949,916
2030	96,179	1,046,095

2015 Baseline Emissions affected, where known:

2016 baseline emissions were used because the formula for calculating unknown leaks changed between 2015 and 2016. 2016 baseline emissions were 214,374 MCF for buried distribution main and service on a five-year leak survey interval. This number includes known and unknown leaks. The

baseline for each class of pipe can be found in the table above. The baseline for all buried distribution pipe, regardless of leak survey cycle, is estimated to be 482,418 MCF of natural gas.

n) Calculation Methodology:

The calculation methodology used to calculate the estimated reduction in emissions is the same methodology used to calculate emissions from the distribution system in the Annual Emissions Report.

1. Derive the annual system leak rates by materials and facilities
2. Estimate the number of leaks detected and their associated emissions when shifting the survey cycle from 5-year to annual
3. Project emissions reduction in future years during and after implementation of this best practice

This methodology is based on the assumptions that:

- Leaks develop on the system at a linear rate over the entire leakage survey cycle
- The system performance is stable and the annual system leak rate is fairly constant over the entire system including the un-surveyed portion of the system
- The rate of leak repair is assumed to be constant throughout the year, which results in an average leak duration time of 6 months for all repaired leaks
- O&M leaks are assumed will not have an impact in the emissions reduction estimation
- All leaks are assumed to have been leaking since the beginning of the year at the full emission factor leak rate
- Known system leaks are allocated to the various leak survey cycles based on the annual system leak rate
- The number of unknown leaks is assumed to be zero since there are no areas that are not surveyed during the year of interest
- The 2016 emissions inventory is used as the baseline due to changes in reporting templates made from the 2015

o) Additional Comments:

N/A

p) Overlap with Safety:

Leak surveys are currently performed to meet safety requirements as defined in 49 CFR 192.723. The activities in this Best Practice are incremental to safety.

SUPPLEMENTAL INFORMATION

a) Technology:

b) Changes to Operations:

The accompanying attachments have been redacted to remove non-responsive, non-relevant employee information.

Attachment K: Red-lined draft of Gas Standard 223.0100

Attachment L: Red-lined draft of Gas Standard 184.0005

c) Research or Studies:

d) Other:

Best Practice 16: Special Leak Surveys

2018 LEAK ABATEMENT COMPLIANCE PLAN TEMPLATE (D.17-06-015)

PART 1: OVERVIEW

a) Best Practice: #16

b) Status: Work pending approval of AL 5211

Utilities shall conduct special leak surveys, possibly at a more frequent interval than required by G.O. 112-F (or its successors) or BP 15, for specific areas of their transmission and distribution pipeline systems with known risks for natural gas leakage. Special leak surveys may focus on specific pipeline materials known to be susceptible to leaks or other known pipeline integrity risks, such as geological conditions. Special leak surveys shall be coordinated with transmission and distribution integrity management programs (TIMP/DIMP) and other utility safety programs. Utilities shall file in their Compliance Plan proposed special leak surveys for known risks and proposed methodologies for identifying additional special leak surveys based on risk assessments (including predictive and/or historical trends analysis). As surveys are conducted over time, utilities shall report as part of their Compliance Plans, details about leakage trends. Predictive analysis may be defined differently for differing companies based on company size and trends.

PART 2: BEST PRACTICE DETAILS

a) Historic work:

Leak surveys on distribution lines are performed according to the requirements in 49 CFR 192.723 for safety. Labor and non-labor expenses related to surveying the gas distribution system for leaks has historically been requested through the General Rate Case Application. SoCalGas pipelines are typically leak surveyed at intervals of one, three, or five years. The frequency of this survey is determined by, among other things, the pipe material involved (i.e. plastic or steel), the operating pressure, whether the pipe is under cathodic protection, identified threats such as geological hazards, leak history, and the proximity of the pipe to various population densities. In the 2019 General Rate Case, SoCalGas is requesting cost recovery to increase the survey cycle for all Pre-1986 Aldyl-A or Non-State-of-the-Art Plastic (NSOTA) pipe from 5-year to annual for pipeline safety and integrity reasons, which has a co-benefit of emission reductions. The leak survey cycle for unprotected steel is currently three years.

SoCalGas currently performs special leak surveys, such as:

- Ahead of street improvement surveys. SoCalGas coordinates with cities and franchises so when they schedule street work, SoCalGas proactively performs underground leak surveys and make repairs to underground leaks before the street is paved. This minimizes impact to ratepayers by reducing costs for repaving and labor, in addition to mitigating leaks.
- After the occurrence of any significant event such as an earthquake or landslide over or adjacent to high pressure pipelines or related facilities

- When increasing the maximum allowable operating pressure of a pipeline
- When survey requirements are not considered adequate because of pipe condition or limited opportunity for gas to vent safely
- When there is need to monitor pipe condition for special situations, such as material evaluations.

These special leak surveys are performed to improve safety but provide the added benefit of reducing emissions by identifying leaks earlier than they would be based on routine leak survey schedules.

At a programmatic level, dynamic segmentation is being applied as a part of SoCalGas' early vintage replacement program analysis where SoCalGas assesses individual pipeline segments and relatively rank them by evaluating pipeline segment performance. This type of analysis identifies specific mitigation activities and helps better prioritize work. For the replacement of the early vintage steel (bare steel), a wholesale replacement of the bare steel main population regardless of pipe performance was considered as part of RAMP in the 2019 General Rate Case Application, and following that assessment, the scope was tailored to address bare steel pipelines with a history of poor performance. As part of the replacement, the performance of the bare steel main will be monitored to determine when adjustment to the replacement rate is warranted.

b) Alternative Proposal to BP or exemption? No

c) Proposed Plan:

SoCalGas recommends moving unprotected steel from a three-year cycle to annual surveys, which has a cost-effectiveness of \$34/MCF.

As you can see in the charts below, SoCalGas currently spends only 21% of survey time performing leak surveys on unprotected steel pipe that contributes 56% of the emissions.

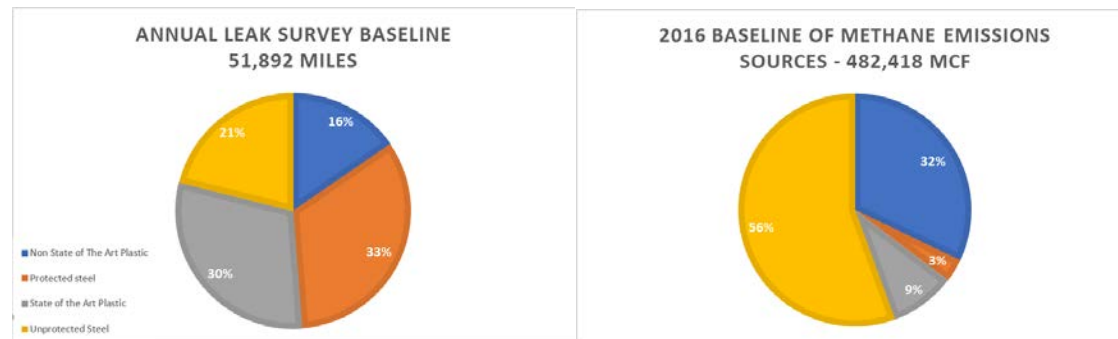

The charts below reflect SoCalGas' alternative proposal to Best Practice 15, which recommends keeping high performing protected steel pipe and state of the art plastic pipe on 5-year cycles while moving non-state of the art plastic and unprotected steel to annual cycles. With this proposal, more

time is invested in addressing pipes with higher leak rates, and for a similar investment, achieves a much higher emissions reduction.

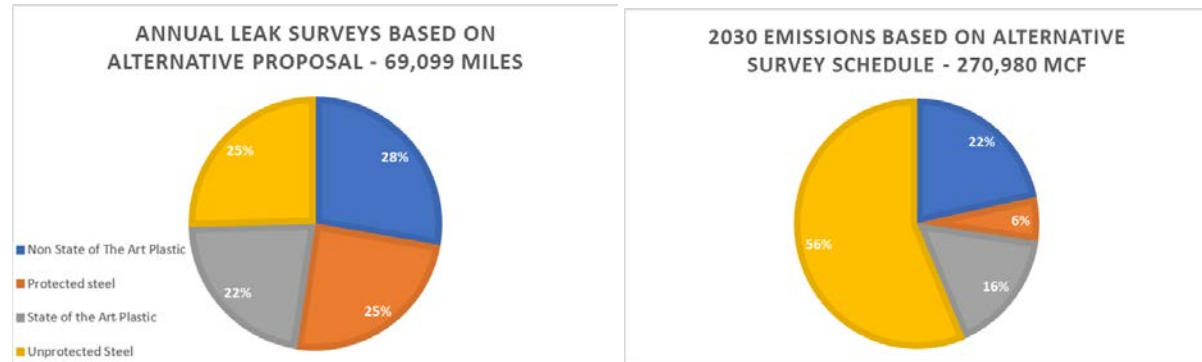

SoCalGas is participating in two research projects led by the California Energy Commission related to this Best Practice:

- CEC - Storage Research Project (GFO-16-508)
Develop advanced risk assessment models including new tools, technologies, methods, methodologies, and approaches to improve underground natural gas storage infrastructure safety and integrity management in California.
- CEC – Natural Gas Pipeline Integrity Safety and Integrity Management Research Grants (GFO-15-506)
Develop a spatial risk model for all fugitive leaks with the goal of identifying locations where Special Leak Surveys would result in meaningful emissions reduction. The model would be designed to integrate with Pipeline Integrity TIMP, DIMP, & SIMP risk models.

Moving forward from a Research & Development perspective, the results from these projects will be reviewed and incremental R&D activities may be identified to meet the objectives of this Best Practice. In addition, demonstrations and pilot studies may also be needed to determine the cost of implementation and effectiveness of using the results of these projects for reducing natural gas emissions.

d) Overlap with other regulations? What portion of the BP is incremental beyond those regulations?

Leak surveys on distribution lines are performed according to the requirements in 49 CFR 192.723 for safety. The leak surveys recorded for this Best Practice are incremental to those currently performed for safety reasons.

e) What technology is required to implement the best practice and why?

Work will need to be performed in SAP and GIS systems to update compliance measures and requirements for all the line segments that will have changes in leak survey requirements. Funding for this work was incorporated into the system upgrades requested in Best Practice 15.

Each incremental field leak survey and QA employee will require a Heath RMLD, a Heath DPIR, and a company vehicle. The incremental supervisors will need company vehicles.

f) Will work require additional personnel and/or contract support? If so, please provide details.

Thirteen incremental leak surveyor employees are needed to perform this work. In addition, supervisors, office employees, and QA employees requested in Best Practice 15 will support the work proposed in this Best Practice.

g) What changes to existing operations are required? How will those changes be implemented?

Changes to how leak surveys will be performed are captured in Best Practice 20B, using new technology required for leak surveyors to geographically track their work. Changes captured in this Best Practice only cover the frequency in which the leak surveys will be performed. Those changes will be implemented by hiring and training new employees, updating software systems to meet compliance needs by changing requirements in SAP and GIS, and performing the incremental leak surveys.

h) What are the new procedures to develop or existing procedures to modify? Please provide details.

Gas standards will need to be updated to reflect the increased leak survey intervals required by this best practice. Redlined gas standards 184.0005 and 223.0100 are attached.

i) Timeline for implementation (Milestones):

All milestones are listed as the approximate length of time to completion from the date cost recovery is approved.

Milestones for unprotected steel special leak surveys

- SAP/GIS updates: 3 months
- Equipment purchased and received: 6 months
- Policy review: 2 months
- Training development: 3-6 months
- Hiring and training new employees: 6-12 months
- Training of existing field employees: 6-12 months
- Publishing policy changes: 12 months
- Full implementation: 12 months

Milestones for CEC - Storage Research Project (GFO-16-508)

- Notice of Proposed Award – March 29, 2017
- Awarded to Lawrence Berkeley National Laboratory and Det Norske Veritas Inc.
- Anticipated Agreement Start Date: 6/30/2017
- Anticipated Agreement End Date: 12/29/2019

Milestones for Pipeline Integrity Research Project: System Integrity Spatial Analysis of Risk & System Threats

- CEC - Natural Gas Pipeline Safety and Integrity Management Research Grants (GFO-15-506)
 - Notice of Proposed Award – April 18, 2016
 - Awarded to Det Norske Veritas Inc.
 - Anticipated Agreement Start Date: 6/30/2016
 - Anticipated Agreement End Date: 3/31/2018

j) Identify the range of factors or considerations used to determine cost-effectiveness of this measure, when costs estimates have been determined:

Cost-effectiveness evaluations were generated by calculating the cumulative revenue requirement for activities that directly contribute to emissions reductions. The activity costs used to calculate the revenue requirement include the fully loaded and escalated capital investment and associated O&M, including on-going O&M over the useful life of the related capital asset, if applicable. The cumulative revenue requirement was divided by the total years of useful life to generate an average annual revenue requirement. Multiplying this annual average revenue requirement by 12 gives the estimated total cost of implementation for the SB 1371 program from 2018 through 2030.

Annual emissions reductions were compounded and summed to generate a total emissions reduction over the twelve-year program period.

Cost benefits were evaluated at the forecasted average annual WACOG published in the 2016 California Gas Report, converted to cost per MCF using a BTU conversion factor of 1.0343.

Cost-effectiveness is generated by dividing the cost of implementation less any cost benefits by estimated emission reduction.

Overall Cost-Effectiveness

The revenue requirement for this Best Practice over the period from 2018-2030 is estimated at \$48,283,716.

Cost Benefits over the period from 2018-2030 are estimated at \$5,177,935. Details are in section K.

The compounded emissions reductions from 2018-2030 for this activity are estimated at 1,264,425 MCF. Details are in section M.

Overall cost-effectiveness = $(\$48,283,716 - \$5,177,935) / 1,264,425 \text{ MCF} = \$34/\text{MCF}$

k) Identify any cost benefits from this BP, when cost estimates are known:

Cost benefits are cost of gas saved by reducing emissions, estimated at \$5,177,935 over 2018-2030. Cost benefits were evaluated at the forecasted average annual WACOG published in the 2016 California Gas Report, converted to cost per MCF using a BTU conversion factor of 1.0343.

Year	WACOG (\$/MCF)	Reduced Emissions	Cost Benefits
2019	\$2.664188	29,474	\$78,524
2020	\$2.649745	83,233	\$220,546
2021	\$2.986593	114,399	\$341,663
2022	\$3.475680	115,258	\$400,599
2023	\$3.743690	115,258	\$431,489
2024	\$3.952100	115,258	\$455,510
2025	\$4.224613	115,258	\$486,919
2026	\$4.525677	115,258	\$521,619
2027	\$4.624728	115,258	\$533,036
2028	\$4.734834	115,258	\$545,726
2029	\$4.944888	115,258	\$569,937
2030	\$5.139493	115,258	\$592,367

l) Do any incremental costs, if known, or benefits overlap with other BPs? If so, to which BP do they overlap, what are they, and how do they overlap?

The incremental supervisors, office employees, and quality assurance (QA) employees requested in Best Practice 15 will also be used for the work in Best Practice 16. The system upgrades requested in Best Practice 15 will also be used to cover the system upgrades needed for Best Practice 16.

m) Anticipated Emissions Reductions from this BP:

Emission reductions in 2019 are estimated at 29,474 MCF. Total reductions for this best practice through 2024 are estimated at 115,258. After the first six years of implementation, emission reductions are expected to levelize.

Scenario	Emissions [MCF]						
	2016 Baseline	Yr 1	Yr 2	Yr 3	Yr 4	Yr 5	Yr 6
Unprotected Steel Pipe from 3Yr to 1Yr	268,043	238,569	184,810	153,644	152,785	152,785	152,785

Year	Year-of emissions reductions (MCF)	Compounded Emissions Reductions (MCF)
2019	29,474	29,474
2020	83,233	112,707
2021	114,399	227,106
2022	115,258	342,363
2023	115,258	457,621
2024	115,258	572,879
2025	115,258	688,137
2026	115,258	803,394
2027	115,258	918,652
2028	115,258	1,033,910
2029	115,258	1,149,168
2030	115,258	1,264,425

2015 Baseline Emissions affected, where known:

The baseline used is 2016 to maintain continuity of measurement, since there were changes to the way emissions were quantified between 2015 and 2016. In 2016 the baseline for unprotected steel pipe is estimated to be 268,043 MCF.

n) Calculation Methodology:

The calculation methodology used to calculate the estimated reduction in emissions is the same methodology used to calculate emissions from the distribution system in the Annual Emissions Report.

1. Derive the annual system leak rates by materials and facilities
2. Estimate the number of leaks detected and their associated emissions when shifting the survey cycle from 5-year to annual
3. Project emissions reduction in future years during and after implementation of this best practice

The methodology is based on the assumptions that

- Leaks develop on the system at a linear rate over the entire leakage survey cycle
- System performance is stable and the annual system leak rate is fairly constant over the entire system, including the un-surveyed portion of the system
- The rate of leak repair is assumed to be constant throughout the year, which results in an average leak duration time of 6 months for all repaired leaks
- O&M leaks are assumed not to have an impact in the emissions reduction estimation
- All leaks are assumed to have been leaking since the beginning of the year at the full emission factor leak rate
- Known system leaks are allocated to the various leak survey cycles based on the annual system leak rate
- The number of unknown leaks is assumed to be zero since there are no areas that are not surveyed during the year of interest.
- The 2016 emissions inventory is used as the baseline due to changes in reporting templates made from the 2015.

o) Additional Comments:

N/A

p) Overlap with Safety:

Leak surveys on distribution lines are performed according to the requirements in 49 CFR 192.723 for safety. Special leak surveys are performed to improve safety but provide the added benefit of reducing emissions by identifying leaks earlier than they would be based on routine leak survey schedules. These activities reduce methane emissions in addition to serving the primary goal of safety and system integrity.

SUPPLEMENTAL INFORMATION**a) Technology:****b) Changes to Operations:**

The accompanying attachments have been redacted to remove non-responsive, non-relevant employee information.

Attachment K: Red-lined draft of Gas Standard 223.0100

Attachment L: Red-lined draft of Gas Standard 184.0005

c) Research or Studies:**d) Other:**

Best Practice 17: Enhanced Methane Detection

2018 LEAK ABATEMENT COMPLIANCE PLAN TEMPLATE (D.17-06-015)

PART 1: OVERVIEW	
a) Best Practice: #17	b) Status: Work pending approval of AL 5211
Utilities shall utilize enhanced methane detection practices (e.g. mobile methane detection and/or aerial leak detection) including gas speciation technologies.	
PART 2: BEST PRACTICE DETAILS	
a) Historic work:	
<p>SoCalGas currently has a very robust laboratory known as the Engineering Analysis Center (EAC). When a methane source is in question, the EAC will dispatch a mobile gas speciation van to identify the chemical content of the gas (speciation) and identify if the gas is from the SoCalGas system. The EAC provides system-wide testing and engineering analysis primarily to internal departments such as Distribution, Transmission, Storage, Customer Services, & Marketing, which are instrumental in making critical operational decisions. The testing and engineering services include:</p>	
<ul style="list-style-type: none">• Gas leak Investigations, migrations, and mitigation testing and analysis• Environmental testing/ Waste characterization and disposal• Gas quality and gas odorization• Btu measurements for billing• Material & Equipment testing and evaluations• Pressure vessels inspections• Failure Analysis/Contaminants identifications• Vibration & Noise Analysis• Corrosion analysis and control• Gas Equipment evaluations & efficiency testing• Source & emissions testing• Engine & Compressor performance analysis• Green House gas emissions testing• NOx, Hydrocarbon, and VOC analyses	
<p>SoCalGas also has a Research, Development, and Demonstration group that coordinates research projects with different partners and technology vendors to evaluate the capabilities of new technologies to further improve safety and emissions standards. SoCalGas has a successful history conducting Research, Development, and Demonstration (RD&D) activities to advance technologies and products that promote safety, resiliency and reliability of the natural gas infrastructure, energy efficiency and environmental benefits. The RD&D Program was formalized in the 1980's, through the California Public Utility Commission's (CPUC) Decision D.82-12-05, and has been re-authorized in each</p>	

subsequent rate case. SoCalGas' General Rate Case D.16.06.054, for the period covering 2016-2018 is the most recent. Because of the consistent support and funding authorized by the CPUC for this program, SoCalGas is an industry leader in RD&D. SoCalGas has introduced and developed new and advanced technologies that benefit ratepayers for operational and environmental advances. SoCalGas RD&D program generates ratepayer benefits by developing and demonstrating advanced technologies that create environmental and energy efficiency benefits related to the use of natural gas and operational improvements such as enhanced safety and reliability. A copy of the 2017 Annual Report for the SoCalGas RD&D group has been attached.

b) Alternative Proposal to BP or exemption? No

c) Proposed Plan:

SoCalGas plans to expand the capacity of the Engineering Analysis Center (EAC) to respond to requests from Operations for leak speciation where a methane source is in question. Current on-site identification of methane emissions is very robust. The lower detection limits of new advanced leak detection instrumentation plus increased level of leak survey activities being driven by SB 1371 requires an expansion of these resources.

SoCalGas is currently supporting two active research projects related to leak detection:

- Aerial Leak Detection Research Projects
 - PRCI – Fast Accurate Leak Detection (PRCI ROW-3H)
 - NYSEARCH - UAS Technology (M2014-001)
- Methane Detection Sensor & Systems Research Projects
 - OTD - Evaluation of Methane Detection Devices for Utility Operations (OTD 7.17.e)

Moving forward, incremental activities or changes in scope to these projects may be needed to assess the impact of the project on system methane emissions. Additional demonstrations and pilot studies may also be needed to determine the cost of implementation and effectiveness of using the results of these projects for reducing natural gas emissions.

SoCalGas also proposes the following research, development, demonstration and pilot projects designed to further advance the integration and use of new leak detection technologies:

- Aerial (UAS) Leak Detection Research Projects

Unmanned Aerial System (UAS, aka Drones) R&D projects to develop capability for aerial methane emissions detection and quantification from the Company's above and below-ground facilities that are difficult or hazardous to access from the ground. The technology for both the aircraft and the technology payload(s) needed to perform the inspections are advancing and changing rapidly. Various software applications and associated business processes needed to manage the large volumes of data collected must be evaluated, demonstrated, and piloted. Management of FAA regulatory compliance requirements must also be developed.

- Large Leak Detection & Quantification - JPL Basin Monitoring Research Projects
Collaborate with JPL to evaluate leveraging the JPL LA basin monitoring (Tower network and CLARS) plus airborne data (AVIRIS, HyTES, or new imaging technologies) to detect and rapidly respond to indications of potential large leaks on the Company system. This effort will also look at the possibility of leveraging other Company datasets such as leak data, geospatial asset information, geospatial and time-series events such as blowdowns, customer odor complaint data, and aggregated consumption data within geospatial quadrants from the Advanced Meter System to help refine top down and bottom up atmospheric measurements of various types used to derive methane inventory estimates.
- Below Ground Methane "background" concentration Study Research Projects
Methane can occur naturally underground, and can vary in a similar manner to background levels of methane in the atmosphere that varies over time and are attributable to numerous sources. This study will investigate pipeline variables, variables in the operating environment, and pedology that may need to be considered by pipeline operators in deciding whether or not methane measurements are indicative of a leak from the natural gas piping system. "Background" methane concentration below-ground (in soil) will be studied by measuring below-ground methane concentrations across the SoCalGas service territory in locations without the presence of a leak. The results may be helpful in understanding better the influence of soil morphology in establishing lower threshold methane concentrations to assist with leak detection, or provide some insights about below-ground methane measurements related to soil types and history.
- Methane Detection Sensor & Systems Research Projects
Assess the ability of integrating highly sensitive (ppb-level) backpack-style or handheld methane/ethane atmospheric measurement devices during walking leak survey to more quickly detect and locate system leaks. Leverage concept of tiered, multi-layered data analytics approach to integrate atmospheric methane concentration measurements, ground-surface-level measurements, and under-ground methane concentration measurements data.
- Integrate Mobile Methane Mapping w/Mobile Leak Survey Research Project
Evaluate possibility of integrating GIS and wind (speed & direction) data into traditional mobile leak survey applications where mobile leak survey is conducted directly over the pipeline right-of-way. Increase the leak detection capabilities of mobile methane mapping by integrating multiple methane detection systems to increase lower detection limit and minimize false-positive indications.

d) Overlap with other regulations? What portion of the BP is incremental beyond those regulations?

SoCalGas has a successful history conducting Research, Development, and Demonstration (RD&D) activities to advance technologies and products that promote safety, resiliency and reliability of the

natural gas infrastructure, energy efficiency and environmental benefits. SoCalGas has introduced and developed new and advanced technologies that benefit ratepayers for operational and environmental advances. SoCalGas RD&D program generates ratepayer benefits by developing and demonstrating advanced technologies that create environmental and energy efficiency benefits related to the use of natural gas and operational improvements such as enhanced safety and reliability. The SoCalGas RD&D team regularly partners with governing bodies on research projects, including Jet Propulsion Laboratory (JPL), California Air Resources Board (CARB), Department of Energy (DOE), and California Energy Commission (CEC). The partnerships enhance the body of knowledge produced from the research and help SoCalGas focus research efforts on concerns of governing agencies to address operational, environmental, and technological concerns.

e) What technology is required to implement the best practice and why?

There are numerous sources of methane within SoCalGas's service territory. While performing leak detection activities SoCalGas routinely identifies methane emissions that are not associated with the company's pipeline infrastructure and require the use of advanced technologies to speciate the natural gas and differentiate its possible source. Methane detection at lower detection levels compounds the problem with false-positive methane readings that can contribute to non-value-added activities. To perform this analysis mobile laboratory vans are needed. SoCalGas currently has one gas speciation van but the increased leak surveys required by SB-1371 and the ability to detect methane at lower concentration levels requires an additional van and associated equipment.

f) Will work require additional personnel and/or contract support? If so, please provide details.

Yes, two incremental employees will be needed. One to perform the gas speciation out of the Engineering Analysis Center, and one to perform Research, Development, and Demonstration activities.

g) What changes to existing operations are required? How will those changes be implemented?

No changes to operations are required, these are simply incremental activities to operational activities as they are currently performed.

h) What are the new procedures to develop or existing procedures to modify? Please provide details.

N/A

i) Timeline for implementation (Milestones):

All milestones are listed as the approximate length of time to completion from the date cost recovery is approved.

Milestones for gas speciation van

- Purchase gas speciation van: 6 months
- Hire and train new employees: 9 months
- Purchase and install mobile gas speciation technologies in van: 18 months

Estimated Milestones for proposed research projects

- Aerial Leak Detection Research Project
 - PRCI – Fast Accurate Leak Detection (PRCI ROW-3H)
 - Project Start Date: Jan 2014
 - Anticipated Project End Date: Feb 2019
 - NYSEARCH - sUAS Technology (M2014-001)
 - Project Start Date: March 2015
 - Anticipated Project End Date: June 2018
 - In-House UAS Downward-Looking Laser Leak Detection Technology Development
 - Project Start Date – Jan 2018
 - Anticipated End Date – Q4 2018
- Large Leak Detection - JPL Basin Monitoring Research Project
 - Develop Project Scope and Agreement – Q3 2018
 - Anticipated Start Date – Q4 2018
 - Anticipated End Date – Q4 2021
- Below Ground Methane "background" concentration Study Research Project
 - Develop Project Scope, Solicitation, Award, & Agreement – Q2 2019
 - Anticipated Start Date – Q2 2019
 - Anticipated End Date – Q4 2021
- Integrate Mobile Methane Mapping w/Mobile Leak Survey Research Project
 - Develop Project Scope, Solicitation, Award, & Agreement – Q2 2019
 - Anticipated Start Date – Q2 2019
 - Anticipated End Date – Q4 2021

j) Identify the range of factors or considerations used to determine cost-effectiveness of this measure, when costs estimates have been determined:

There is insufficient data to estimate emission reductions for this activity.

k) Identify any cost benefits from this BP, when cost estimates are known:

There is insufficient data to estimate cost benefits for the activities in this Best Practice.

l) Do any incremental costs, if known, or benefits overlap with other BPs? If so, to which BP do they overlap, what are they, and how do they overlap?

The RD&D costs overlap with Best Practices 15, 16, 18, and 19 in that they evaluate technologies for methane detections and could ultimately change the operational activities for leak detection.

m) Anticipated Emissions Reductions from this BP:

<p>There is insufficient data to estimate emission reductions for these activities.</p> <p>2015 Baseline Emissions affected, where known:</p> <p>N/A</p>
<p>n) Calculation Methodology:</p> <p>N/A</p>
<p>o) Additional Comments:</p> <p>N/A</p>
<p>p) Overlap with Safety:</p> <p>N/A</p>
<p>SUPPLEMENTAL INFORMATION</p>
<p>a) Technology:</p>
<p>b) Changes to Operations:</p>
<p>c) Research or Studies:</p> <p>Attachment M: California Energy Commission Notice of Proposed Awards Attachment N: RD&D 2017 Annual Report</p>
<p>d) Other:</p>

Best Practice 18: Stationary Methane Detectors

2018 LEAK ABATEMENT COMPLIANCE PLAN TEMPLATE (D.17-06-015)

PART 1: OVERVIEW	
a) Best Practice: #18	b) Status: Work pending approval of AL 5211
<p>Utilities shall utilize Stationary Methane Detectors for early detection of leaks. Locations include: Compressor Stations, Terminals, Gas Storage Facilities, City Gates, and Metering & Regulating (M&R) Stations (M&R above ground and pressures above 300 psig only). Methane detector technology should be capable of transferring leak data to a central database, if appropriate for location.</p>	
PART 2: BEST PRACTICE DETAILS	
a) Historic work:	
<p>SoCalGas conducted a pilot in 2016 on remote methane sensor technology which can be integrated with their Advanced Meter (AM) radio network. The methane sensing system network would provide an early leak detection warning for the gas pipeline system serving the community so corrective or emergency response could be deployed in an efficient and timely manner based on situational awareness.</p> <p>Based on the results of these pilot studies, SoCalGas requested funding in the 2019 GRC to install the methane monitoring project. This project would include the installation of 2,100 methane monitoring sensors along pipeline routes where high pressure lines 12" or greater in diameter are located in close vicinity to high population density areas, areas with logistical evacuation challenges, or areas with special implication to commerce such as bridges and transportation centers. The driver for these methane detectors is safety and they are only being installed in high consequence areas where safety is a concern.</p>	
b) Alternative Proposal to BP or exemption? Yes	
c) Proposed Plan:	
<p>Options 1: Because no data exists that is specific to leakage emissions from any of these types of facilities, it is difficult to generate an estimated emissions reduction or cost-effectiveness for this activity. SoCalGas installed a fenceline methane monitoring system at a storage facility in 2016 and has found the system to be very expensive and time consuming to maintain. Without the ability to provide a solid estimate of emissions reductions, SoCalGas recommends piloting some of these sensors for a two-year period to provide a better evaluation of cost-effectiveness. SoCalGas would like to propose installing 10-20 sensors in each of the locations recommended to evaluate the ongoing cost of maintaining the units, the accuracy or leak detection, and the amount of false alarms.</p>	

SoCalGas would also like to compare this data to what is discovered as a result of the leak surveys completed in Best Practice 19 and identify how many more incremental emissions reductions these sensors provide when compared to the incremental cost. SoCalGas is prepared to move forward with this activity as outlined but recommends piloting the technology for cost-effectiveness before the program is fully deployed.

SoCalGas is proposing a series of five research projects to support this Best Practice.

- Stationary Methane Detectors Research Project (5 RD&D Projects) Evaluate advanced stationary methane monitoring systems (point sensors and distributed systems) for early notification of leakage at above-ground facilities such as Compressor Stations, Gas Storage Facilities, Metering & Regulating Stations, Residential Buildings, etc.

Option 2: SoCalGas proposes to install the methane sensing system at Compressor Stations, Terminals, Gas Storage Facilities, City Gates, and Metering & Regulating (M&R) Stations (M&R above ground and pressures above 300 psig only) leveraging the AM radio network or existing telemetry systems. The total number of installations in 2019 is anticipated to be 47, with 24 on Distribution M&R stations, 20 at various transmission facilities, and 3 at storage facilities. There will be two more deployments in 2020 and 2021 that will be discussed in the next compliance plan. The total number of above ground sensors to be installed over the three-year period is 236 sensors.

d) Overlap with other regulations? Yes

What portion of the BP is incremental beyond those regulations?

The CARB Oil and Gas Rule requires each natural gas underground storage facility be equipped with continuous air monitoring to measure upwind and downwind ambient concentrations of methane at sufficient locations throughout the facility to identify methane emissions in the atmosphere with the following requirements:

- The monitoring system must have at least one sensor located in a predominant upwind location and at least one sensor located in a predominant downwind location with the ability to continuously record measurements.
- The upwind and downwind instruments shall have the capability to measure ambient concentrations of methane within minimum 250 ppb accuracy to determine upwind and downwind emissions baselines.
- The upwind and downwind instruments shall be calibrated at least once annually unless more frequent calibrations are recommended by the equipment manufacturer. Any defective instrumentation shall be repaired or replaced within 14 calendar days from the date of calibration or the discovery of a malfunction.
- The monitoring system shall have sufficient sensors to continuously measure meteorological conditions at the facility including ambient temperature, ambient pressure, relative humidity, wind speed, and wind direction with the ability to continuously record measurements.

- The monitoring system must have the ability to store at least 24 months of continuous instrument data and the ability to generate hourly, daily, weekly, monthly, and annual reports.
- The monitoring system must have an integrated alarm system that is audible and visible continuously in the control room at the facility and in remote control centers.⁵⁵

These requirements are in line with what SoCalGas anticipates will be expected to meet Best Practice 18 requirements.

e) What technology is required to implement the best practice and why?

SoCalGas successfully integrated the Advanced Meter (AM) Infrastructure radio module with remote methane sensing technology. The AM module developed for the project can communicate with commercially available methane sensors. The AM radio module with communications can conduct reads at 5-minute intervals and provide 15-minute data reporting. In addition, the methane sensor system has alarming capabilities to the host system to send alarms when methane is being detected above specified levels for longer than a certain specified time. The methane sensor technology required is an infrared detector, powered by an internal battery power with solar panel backup, with serial output communication capabilities. The sensors in some locations will have units that can communicate with radio networks as there may not be access to the AM network in some remote locations. Leveraging the existing AM network benefits customers by using an existing investment for a dual purpose to serve public safety and environmental stewardship interests.

f) Will work require additional personnel and/or contract support? If so, please provide details.

Based on experience with fence-line existing methane sensor installations, these units can be extremely maintenance heavy. They require regular calibration and adjustments to continue to perform in the elements. Additional employees will be needed for the ongoing maintenance of these units and to respond to alarms. SoCalGas estimates three incremental FTEs in Transmission, three incremental FTEs in storage, and two incremental FTEs in distribution will be needed when all units have been deployed. SoCalGas also estimates one additional staff engineer to plan, implement, and oversee the methane sensor program. Some locations may require contract support for installation of a 2" diameter pole for the mounting of the methane system, which includes a solar panel, AM radio module, and an enclosure housing the methane sensor.

g) What changes to existing operations are required? How will those changes be implemented?

The local Transmission and Distribution districts will be required to perform annual O&M such as battery change out, methane sensor calibration, solar panel cleaning, and responding to alarms.

h) What are the new procedures to develop or existing procedures to modify? Please provide details.

⁵⁵ "Subarticle 13: Greenhouse Gas Emission Standards." *California Air Resources Board*, 10 Mar. 2017, www.arb.ca.gov/regact/2016/oilandgas2016/oilgasfro.pdf.

Procedures and Gas Standards will need to be developed, reviewed, and published for the methane sensing system to document operational and maintenance procedures.

i) Timeline for implementation (Milestones):

All milestones are listed as the approximate length of time to completion from the date cost recovery is approved.

- Order and receive methane sensors: 3 months
- Panel shop to construct sensor enclosures: 7 months
- Train employees on operational and maintenance procedures: 9 months
- Install first set of sensors in areas where AM network is available: 12 months
- Install second set of sensors: 24 months
- Install third set of sensors: 36 months

Milestones for Stationary Methane Detectors Research Project

- Residential Methane Detector (OTD 1.14.g.4)
 - Project Start Date – 11/1/2017
 - Anticipated End Date – 4/30/2018
- Residential Methane Detector (NYSEARCH M2010-002)
 - Project Start Date – 2/6/2016
 - Anticipated End Date – July 2018
- State of the Art Methane Sensors (ODT 7.16.f)
 - Project Start Date – 7/1/2016
 - Anticipated End Date – 10/30/2018
- Two additional studies are being developed but scope of work has not yet been clearly defined. Technology development is very dynamic and research will focus on identification of R&D objectives targeting emission reductions through above ground methane sensors to meet the unique needs of SoCalGas.

j) Identify the range of factors or considerations used to determine cost-effectiveness of this measure, when costs estimates have been determined:

There isn't sufficient data to estimate an emissions reduction from the activities in this Best Practice.

k) Identify any cost benefits from this BP, when cost estimates are known:

There isn't sufficient data to estimate cost benefits for the activities in this Best Practice.

l) Do any incremental costs, if known, or benefits overlap with other BPs? If so, to which BP do they overlap, what are they, and how do they overlap?

NA

m) Anticipated Emissions Reductions from this BP: There isn't sufficient data to estimate an emissions reduction from the activities in this Best Practice. 2015 Baseline Emissions affected, where known: There isn't sufficient data to generate a baseline of emissions in regard to the activities in this Best Practice.
n) Calculation Methodology: N/A
o) Additional Comments: N/A
p) Overlap with Safety: N/A
SUPPLEMENTAL INFORMATION
a) Technology:
b) Changes to Operations:
c) Research or Studies:
d) Other:

Best Practice 19: Above Ground Leak Surveys

2018 LEAK ABATEMENT COMPLIANCE PLAN TEMPLATE (D.17-06-015)

PART 1: OVERVIEW	
a) Best Practice: #19	b) Status: Work pending approval of AL 5211
<p>Utilities shall conduct frequent leak surveys and data collection at above ground transmission and high-pressure distribution (above 60 psig) facilities including Compressor Stations, Gas Storage Facilities, City Gates, and Metering & Regulating (M&R) Stations (M&R above ground and pressures above 300 psig only). At a minimum, above ground leak surveys and data collection must be conducted on an annual basis for compressor stations and gas storage facilities.</p>	
PART 2: BEST PRACTICE DETAILS	
a) Historic work:	
<p>Above ground leak surveys have historically been completed to meet the requirements of 49 CFR 192 and GO 112F. These surveys meet the requirement for this Best Practice but many of the surveys are not instrumented so leak concentrations are not recorded. Many of the leak surveys are performed using soap tests and by monitoring for sight, sound, and smell leak indications.</p> <p>Minor above ground leaks are typically repaired the same day they are discovered if the technician who discovers the leak has the necessary tools on hand. These small easy repairs have not always been recorded and therefore ability to measure historic emissions from above ground minor leaks is limited.</p> <p>Underground storage fence methane sensors were installed at an Underground Storage facility in October 2016 with extremely sensitive methane detection to monitor atmospheric methane concentrations.</p> <p>CARB Oil and Gas Rule became effective January 1, 2018 and requires quarterly leak surveys on transmission compressor stations and underground storage. Funding for these activities for 2019 was requested in the 2019 General Rate Case.</p> <p>EPA Subpart W leak surveys have been conducted annually for specific Compressor Stations, Underground Storage Facilities, and distribution M&R Stations subject to the EPA Greenhouse Gas Reporting Program (GHGRP).</p>	
b) Alternative Proposal to BP or exemption? No	
c) Proposed Plan:	

SoCalGas proposes to provide Measurement and Regulation (M&R) Technicians with Detecto-Pak Infrared (DPIR) instrumentation to begin performing and recording instrumented leak surveys. Data from the DPIRs will be uploaded into SoCalGas' system using the Bluetooth breadcrumbing technology described in Best Practice 20b. These activities will require incremental training costs and some incremental ongoing labor as more detailed surveys and record keeping procedures will increase the amount of time required to perform above ground leak surveys.

SoCalGas is also proposing to perform quarterly instrumented leak surveys at compressor stations and gas storage facilities. These surveys are also in line with what is required in the CARB Oil and Gas rule, which became effective January 1, 2018 and requires quarterly leak surveys on transmission compressor stations and underground storage.

For 2019, SoCalGas requested funding for these activities in its 2019 General Rate Case.

d) Overlap with other regulations?

This Best Practice is similar to the CARB Oil and Gas Rule which addresses Natural Gas Transmission compressor stations and Underground Storage Facilities. Specifically, the rule calls for quarterly Leak Detection and Repair (\$95669 Leak Detection and Repair - LDAR) using EPA Method 21.

Annual leak surveys are also required under EPA Subpart W for a portion of the company aboveground M&R stations. These are also tested for leak concentration per EPA Method 21.

Above ground surveys on M&R stations are performed according to 49 CFR 192.723 leak survey requirements.

What portion of the BP is incremental beyond those regulations?

The requirement for frequent leak surveys and data collection activities to be conducted on an annual basis at aboveground M&R stations is incremental in that the instrumented surveys and record keeping requirements for SB 1371 will require additional labor, due to an increased amount of time required for surveys.

The requirement for frequent leak surveys and data collection activities to be conducted on an annual basis for compressor stations and gas storage facilities is not incremental beyond CARB Oil and Gas requirements.

e) What technology is required to implement the best practice and why?

The standard technology or tool for conducting EPA Method 21 testing to obtain leak concentration is the Total Vapor Analyzer (TVA) and software that allows data to be entered into a database for retrieval and reporting purposes. Individual leak survey contractors may have proprietary software for data collection and storage, however the utilities require the ability for contractor's software or data to be compatible with company enterprise systems such as Maximo, SAP, etc.

Leak surveys on above-ground facilities will require Detecto-Pak Infrared instrumentation.

f) Will work require additional personnel and/or contract support? If so, please provide details.

Since the CARB Oil and Gas Rule requires Leak Detection and Repair (LDAR) effective January 1, 2018, the resources necessary to conduct annual leak surveys to satisfy SB 1371 requirements at storage fields and compressor stations will already be in place by the time the Compliance Plans are submitted. The leak surveys at transmission stations and storage facilities will be performed by contractors. For stations that are non-operational, the company requests that exemptions be provided from leak survey requirements (based on appropriate justification and documentation). Leak survey contractors are currently used to execute the annual GHG surveys required by Subpart W.

Two incremental M&R technicians are requested for SoCalGas to conduct surveys leak surveys on M&R stations to perform instrumented surveys, which is above and beyond what is required by Subpart W, CARB Oil and Gas, or GO112f requirements.

g) What changes to existing operations are required? How will those changes be implemented?

SoCalGas proposes to provide Measurement and Regulation (M&R) Technicians with Detecto-Pak Infrared (DPIR) instrumentation to begin performing and recording instrumented leak surveys. Above ground leak surveys are currently performed at regular intervals at compressor stations, gas storage facilities, city gates, and M&R facilities with inlet pressures of above 300 psig. However, many of these facilities are gated for safety. The leak surveyors performing surveys on the pipelines leading to above ground M&R facilities may have limited access to perform instrumented surveys. Therefore, surveying responsibilities for above ground M&R stations is managed by the M&R technicians. These surveys are currently performed using soap tests and monitoring for sight, sound, or smell leak indications. If leaks are found, they are typically repaired on the spot and the minor leaks have not always been historically recorded if repair was made immediately.

SoCalGas proposes to provide these M&R technicians with the proper equipment to perform instrumented surveys that could be uploaded into SoCalGas' system using the Bluetooth breadcrumbing technology described in Best Practice 20b. These activities will require incremental training costs and some incremental ongoing labor as these more detailed tests and record keeping procedures will increase the amount of time required to perform above ground leak surveys.

SoCalGas is also proposing to perform quarterly instrumented leak surveys at compressor stations and gas storage facilities. These surveys are also in line with what is required in the CARB Oil and Gas rule, which became effective January 1, 2018 and requires quarterly leak surveys on transmission compressor stations and underground storage. This work will be performed by contractors.

h) What are the new procedures to develop or existing procedures to modify? Please provide details.

Procedures to integrate the testing and data collection efforts across all business units is necessary to provide consistent and relevant data is being collected for SB 1371 reporting. Company procedures will be developed to provide consistent application across organizations.

i) Timeline for implementation (Milestones):

All milestones are listed as the approximate length of time to completion from the date cost recovery is approved.

- Policy development and review: 3 months
- SAP/GIS updates: 3 months
- Leak survey equipment purchased and received: 6 months
- Training development: 3-6 months
- Hiring and training new employees: 6-12 months
- Training of existing field employees: 6-12 months
- Publishing policy changes: 12 months
- Full implementation: 12 months

j) Identify the range of factors or considerations used to determine cost-effectiveness of this measure, when costs estimates have been determined:

There isn't sufficient data to estimate an emissions reduction from the activities in this Best Practice.

k) Identify any cost benefits from this BP, when cost estimates are known:

There isn't sufficient data to estimate cost benefits for the activities in this Best Practice.

l) Do any incremental costs, if known, or benefits overlap with other BPs? If so, to which BP do they overlap, what are they, and how do they overlap?

N/A

m) Anticipated Emissions Reductions from this BP:

There isn't sufficient data to estimate an emissions reduction from the activities in this Best Practice.

2015 Baseline Emissions affected, where known:

There isn't sufficient data to generate a baseline of emissions in regard to the activities in this Best Practice.

n) Calculation Methodology:

N/A

o) Additional Comments:

N/A

p) Overlap with Safety:

Above ground leak surveys are currently performed at regular intervals at compressor stations, gas storage facilities, city gates, and M&R facilities with inlet pressures of above 300 psig for safety reasons as required by 49 CFR 192.723. However, many of these facilities are gated for safety and integrity reasons. The leak surveyors performing surveys on the pipelines leading to above ground M&R facilities may have limited access to perform instrumented surveys. Therefore, surveying responsibilities for above ground M&R stations is managed by the M&R technicians. These surveys are currently performed using soap tests and sight, sound, smell leak indicators. If leaks are found, they are typically repaired on the spot and the minor leaks have not always been historically recorded if repair was made immediately. The incremental work required by this best practice, performing these leak surveys with instrumentation and generating a formal record keeping practice, is incremental to safety requirements.

SUPPLEMENTAL INFORMATION**a) Technology:****b) Changes to Operations:****c) Research or Studies:****d) Other:**

Best Practice 20a: Quantification

2018 LEAK ABATEMENT COMPLIANCE PLAN TEMPLATE (D.17-06-015)

PART 1: OVERVIEW	
a) Best Practice: #20a	b) Status: Work pending approval of AL 5211
<p>Utilities shall develop methodologies for improved quantification and geographic evaluation and tracking of leaks from the gas systems. Utilities shall file in their Compliance Plan how they propose to address quantification. Utilities shall work together, with CPUC and ARB staff, to come to agreement on a similar methodology to improve emissions quantification of leaks to assist demonstration of actual emissions reductions.</p>	
PART 2: BEST PRACTICE DETAILS	
a) Historic work:	
<p>SoCalGas has historically repaired leaks based on safety risk and has coded leaks as grades 1-3 based on proximity to buildings, population density, and concentration of the leak. Leak repair prioritization is based on safety and is not necessarily linked to emissions volume. SoCalGas has used tracer and surface expression techniques in the past, including use of high flow samplers to evaluate leaks at compressor stations in previous research projects.</p> <p>SoCalGas has a successful history conducting Research, Development, and Demonstration (RD&D) activities to advance technologies and products that promote safety, resiliency and reliability of the natural gas infrastructure, energy efficiency and environmental benefits. The RD&D Program was formalized in the 1980's, through the California Public Utilities Commission's (CPUC) Decision D.82-12-05, and has been re-authorized in each subsequent rate case. SoCalGas' General Rate Case D.16.06.054, for the period covering 2016-2018 is the most recent. Because of the consistent support and funding authorized by the CPUC for this program, SoCalGas is an industry leader in RD&D. SoCalGas has introduced and developed new and advanced technologies that benefit customers for operational and environmental advances. SoCalGas RD&D program generates ratepayer benefits by developing and demonstrating advanced technologies that create environmental and energy efficiency benefits related to the use of natural gas and operational improvements such as enhanced safety and reliability. The 2017 RD&D Annual Report is attached, and highlights the activities from 2016 and outlines longer term research strategies and priorities.</p>	
b) Alternative Proposal to BP or exemption? No	
c) Proposed Plan:	

SoCalGas plans to develop a method to differentiate leak locations with potential larger leak rates and to conduct leak quantification resulting in repairs prioritized by leak rate. SoCalGas plans to develop a method to identify and prioritize Code 3 leaks that have high flow leak rates, characterized by a leak rate of 10 CFH or greater. This requires development of a decision tree to triage leak data from recent leak surveys to identify leak with greatest likelihood of being a large leak. SoCalGas will use surface expression measurement to measure leak rates and then prioritize “high flow” Code 3 leaks for more rapid time-to-repair. Technologies to be used and evaluated include:

- Any advancements in surface expression measurement tools
 - High Flow Sampler™
- Mobile Leak Quantification Technologies

SoCalGas also proposes the following pilots and research projects associated with this best practice:

- PE Leak Growth Rate from Slow Crack Growth Research Project
Advance industry understanding of how leak rates tend to grow over time on plastic (PE) pipe once the leak has initiated. Prior work in this area was focused on the process of crack initiation up until a leak occurred. This knowledge will assist in improving system leakage estimate and emission factors, and help to optimize leak survey intervals based on projected emissions growth rates.
- New Mobile Methane Quantification Technologies Research Project
Evaluate mobile methane detection and quantification technologies that can effectively quantify non-hazardous methane emissions in an urban environment. This will enable the prioritization of leak repairs based on emission rates.
- System Emissions using mass balance with Advanced Meter Technology Research Project
Develop the ability to detect and quantify emissions from the Distribution Main and Service network by leveraging the Advanced Meter Analytics, comparing the gas supplied with the gas consumed for a defined service area.
- Quantification of small leaks and define practical lower emission threshold Research Project (OTD 7.17.d)
Develop a simple method of quantifying methane emissions from small aboveground leaks using the response of the leak to a soap test. This may provide the basis for moving away from the current facility-based emission factor for MSAs to a leak-based factor.
- CEC San Joaquin Valley Methane Study Research Project
Field study to identify, quantify and mitigate methane emissions in the southern part of the San Joaquin Valley.
- Facility Emissions Quantification Study Research Project
Field studies to identify and quantify methane emissions from buried and aboveground facilities. Results may support refinement of emission factors to reduce the uncertainty of existing emission factors.

- Validation Study of Advanced Technologies for Natural Gas Transmission and Storage Leak Detection and Emissions Quantification

This research project is currently in process and SoCalGas is evaluating the various technologies based on the data acquired. This project includes a technology assessment and comparison of aerial, ground-based mobile and hand-held technologies in the first Quarter of 2018. The technologies currently being evaluated and compared are:

- Picarro's Emissions Quantification (EQ™) ground-based mobile system for emissions quantification and emissions source pin pointing
- SeekOps System using UAS (Drone) with JPL Methane Sensor payload for emissions quantification and emissions source pin pointing
- SoCalGas System using UAS (Drone) with Pergam Methane Sensor payload for emissions source pin pointing
- Bacharach/Heath Hi Flow Sampler™ for direct measurement at source for emissions quantification

d) Overlap with other regulations? What portion of the BP is incremental beyond those regulations?

The SoCalGas RD&D team regularly partners with governing bodies on research projects, including Jet Propulsion Laboratory (JPL), California Air Resources Board (CARB), Department of Energy (DOE), and California Energy Commission (CEC). The partnerships enhance the body of knowledge produced from the research and help SoCalGas focus research efforts on concerns of governing agencies to address operational, environmental, and technological concerns.

e) What technology is required to implement the best practice and why?

To perform surface expression measurements at identified leak sites, SoCalGas requested funding for high flow samplers and mobile leak quantification devices. SoCalGas will also need to modify data collection software to enable recording of leak size.

For the research projects, the following technologies are needed:

- JPL's AVIRUS-NG
- Picarro's Emissions Quantification (EQ™) ground-based mobile system for emissions quantification and emissions source pin pointing
- SeekOps System using UAS (Drone) with JPL Methane Sensor payload for emissions quantification and emissions source pin pointing
- SoCalGas System using UAS (Drone) with Pergam Methane Sensor payload for emissions source pin pointing
- Bacharach/Heath Hi Flow Sampler™ for direct measurement at source for emissions quantification

f) Will work require additional personnel and/or contract support? If so, please provide details.

Labor resource estimate is based on two-man crew to perform surface expression measurements at the identified leak sites. For SoCalGas it is estimated that the equivalent of two full-time crews would

be needed (4 FTEs). In addition, 1 shared services Project Manager to manage the overall program and data analytics.

g) What changes to existing operations are required? How will those changes be implemented?

SoCalGas has historically repaired leaks based on safety risk and has coded leaks as grades 1-3 based on proximity to buildings, population density, and concentration of the leak. This prioritization is not necessarily linked to emissions volume. This Best Practice proposes to begin prioritizing leaks based on emissions after all safety concerns are met. SoCalGas plans to develop a method to differentiate leak locations with potential larger leak rates and to conduct leak quantification resulting in repairs prioritized by leak rate. SoCalGas will use surface expression measurement to measure leak rates and then prioritize “high flow” Code 3 leaks for more rapid time-to-repair.

h) What are the new procedures to develop or existing procedures to modify? Please provide details.

Gas Standards regarding leak surveys and leak repairs will need to be updated to reflect a method to differentiate leak locations with potential larger leak rates and to conduct leak quantification resulting in leak repairs prioritized by leak rate.

i) Timeline for implementation (Milestones):

All milestones are listed as the approximate length of time to completion from the date cost recovery is approved.

Milestones for large leak prioritization decision tree and technology evaluation:

- Develop business process and decision tree to triage Code 3 leaks: 6 months
- Pilot process, data analysis, and evaluation of technologies: 12 months
- Policy development on leak detection and repair: 18 months
- Training development on new policy guidelines: 20 months
- Training of field employees: 24 months
- Publishing policy changes: 24 months

Milestones for research projects:

- PE Leak Growth Rate from Slow Crack Growth Research Project
 - Project Start Date – 2/1/2016
 - Anticipated End Date – June 2018
- System Emissions using mass balance with Advanced Meter Technology Research Project
 - Anticipated Project Start Date – Q4 2018
 - Anticipated End Date – Q2 2020
- Quantification of small leaks and define practical lower emission threshold Research Project (OTD 7.17.d)
 - Project Start Date – 11/7/2017
 - Anticipated End Date – 3/31/2019

- CEC San Joaquin Valley Methane Study Research Project (CEC GFO-17-502)
 - Notice of Proposed Award – Feb 6, 2018
 - Awarded to Lawrence Berkley National Lab
 - Anticipated Agreement Start Date: 5/7/2018
 - Anticipated Agreement End Date: 12/31/2021
- Facility Emissions Quantification Study Research Project
 - Multi-tiered GHG Emissions Measurements of California's Natural Gas Powered & Fueling Infrastructure-Group 2 (CEC GFO-15-507)
 - Notice of Proposed Award – Nov 22, 2016
 - Awarded to Electric Power Research Institute (EPRI)
 - Anticipated Agreement Start Date: 4/3/2017
 - Anticipated Agreement End Date: 3/31/2020
 - Field Measurement of Leak Flow Rate – Phase 2 (OTD 1.14.d.2)
 - Project Start Date – 1/1/2016
 - Anticipated End Date – 6/30/2018
 - Distribution System Characterization (OTD 7.16.h)
 - DOE Co-Funded Project (DE-FOA-0001538)
 - Project Start Date – 10/1/2016
 - Anticipated End Date – 3/31/2019
 - Research Leak Data Variables for Identification of Potential Large Leaks and Develop Preliminary Methodology to Triage Leak Data for Repair Prioritization
 - Research Project Start Date – 1/1/2017
 - Anticipated Pilot Study Start Date – Q1 2019
 - Anticipated Pilot Study and Project End Date – Q1 2020
- Transmission/Storage New Mobile Methane Quantification Technologies Research Project
 - Assessment of Commercially Available Technologies for Emissions Location Pin-Pointing and Facility Emissions Flux Rate Measurement within Complex Natural Gas Operational Facility Environments
 - Project Start Date – Nov 2017
 - Anticipated End Date – Q4 2019

j) Identify the range of factors or considerations used to determine cost-effectiveness of this measure, when costs estimates have been determined:

Cost-effectiveness evaluations were generated by calculating the cumulative revenue requirement for activities that directly contribute to emissions reductions. The activity costs used to calculate the revenue requirement include the fully loaded and escalated capital investment and associated O&M, including on-going O&M over the useful life of the related capital asset, if applicable. The cumulative revenue requirement was divided by the total years of useful life to generate an average annual revenue requirement. Multiplying this annual average revenue requirement by 12 gives the estimated total cost of implementation for the SB 1371 program from 2018 through 2030.

Annual emissions reductions were compounded and summed to generate a total emissions reduction over the twelve-year program period.

Cost benefits were evaluated at the forecasted average annual WACOG published in the 2016 California Gas Report, converted to cost per MCF using a BTU conversion factor of 1.0343.

Cost-effectiveness is generated by dividing the cost of implementation less any cost benefits by estimated emission reduction.

Overall Cost-Effectiveness

The average annual revenue requirement for this Best Practice is \$1,997,489. Over the twelve-year period from 2018-2030, the total revenue requirement is estimated at \$23,969,868.

Cost Benefits over the period from 2018-2030 are estimated at \$5,806,462. Details are in section K.

The compounded emissions reductions from 2018-2030 for this activity are estimated at 1,461,780 MCF. Details are in section M.

Overall cost-effectiveness = $(\$23,969,868 - \$5,806,462) / 1,461,780 \text{ MCF} = \$12/\text{MCF}$

k) Identify any cost benefits from this BP, when cost estimates are known:

The cost of gas saved by reducing emissions, estimated at \$5,806,462 over 2018-2030. Cost benefits were evaluated at the forecasted average annual WACOG published in the 2016 California Gas Report, converted to cost per MCF using a BTU conversion factor of 1.0343.

Year	WACOG (\$/MCF)	Reduced Emissions	Cost Benefits
2019	\$2.664188	121,815	\$324,538
2020	\$2.649745	121,815	\$322,779
2021	\$2.986593	121,815	\$363,812
2022	\$3.475680	121,815	\$423,390
2023	\$3.743690	121,815	\$456,038
2024	\$3.952100	121,815	\$481,425
2025	\$4.224613	121,815	\$514,621
2026	\$4.525677	121,815	\$551,295
2027	\$4.624728	121,815	\$563,361
2028	\$4.734834	121,815	\$576,774
2029	\$4.944888	121,815	\$602,361
2030	\$5.139493	121,815	\$626,067

l) Do any incremental costs, if known, or benefits overlap with other BPs? If so, to which BP do they overlap, what are they, and how do they overlap?

The activities proposed in this Best Practice are complementary to Best Practices 15, 16, and 21 which set requirements for leak survey frequency and timeline for leak repair. There is no cost overlap identified.

m) Anticipated Emissions Reductions from this BP:

Assumptions:

- 5% of Code 2 + Code 3 leaks are anticipated to be large leaks based on measured system leaks.
- Time to repair the large leaks is assumed to be 10 days from date of discovery. Actual timeline to repair will vary based on the location of the leak, availability of crews, current workload, and operational constraints. Policy will be developed internally on actual repair requirements for large leaks.
- Average flow rate of large leak is 26 CFH based on the weighted average of 6 leaks 10 CFH or greater during pilot study.

SCG	Code 2	Code 3	Total
Count of Leaks Discovered in the Year of Interest	1,127	4,462	5,589
Average Days to Repair Leaks	164	838	N/A
Estimated # of large leaks	56	223	279
2016 Baseline Emissions [MCF]	33,829	177,374	211,203
Emissions Reduction [MCF]	5,454	116,362	121,815

Year	Year-of emissions reductions (MCF)	Compounded Emissions Reductions (MCF)
2019	121,815	121,815
2020	121,815	243,630
2021	121,815	365,445
2022	121,815	487,260
2023	121,815	609,075
2024	121,815	730,890
2025	121,815	852,705
2026	121,815	974,520
2027	121,815	1,096,335
2028	121,815	1,218,150
2029	121,815	1,339,965
2030	121,815	1,461,780

2015 Baseline Emissions affected, where known:

2016 Baseline is 211,203 MCF

n) Calculation Methodology:

Emissions reduction estimate is based on preliminary study and the following assumptions:

- Approximately 5% of Code 2 and Code 3 leaks are expected to have flow rates of 10 CFH or greater (characterized as “high flow” leaks)

<ul style="list-style-type: none"> • Time to repair the large leaks is assumed to be 10 days from date of discovery. Actual timeline to repair will vary based on the location of the leak, availability of crews, current workload, and operational constraints. Policy will be developed internally on actual repair requirements for large leaks. • Weighted average flow rate of large leaks will be approximately 26 CFH. This leak rate is based on findings in preliminary study.
<p>o) Additional Comments:</p> <p>N/A</p>
<p>p) Overlap with Safety:</p> <p>SoCalGas has historically repaired leaks based on safety risk and has coded leaks as grades 1-3 based on proximity to buildings, population density, and flow rate of the leak. This prioritization is based on safety and is not necessarily linked to emissions volume. Safety will continue to be SoCalGas' first priority but after all safety concerns have been addressed, leak repairs will be prioritized based on potential emission reductions.</p>
<p>SUPPLEMENTAL INFORMATION</p>
<p>a) Technology:</p>
<p>b) Changes to Operations:</p>
<p>c) Research or Studies:</p> <p>Attachment N: SoCalGas 2017 RD&D Annual Report</p>
<p>d) Other:</p>

Best Practice 20b: Geographic Tracking

2018 LEAK ABATEMENT COMPLIANCE PLAN TEMPLATE (D.17-06-015)

PART 1: OVERVIEW		
a) Best Practice: #20b		b) Status: Work pending approval of AL 5211
<p>Utilities shall develop methodologies for improved geographic tracking and evaluation of leaks from the gas systems. Utilities shall work together, with CPUC and ARB staff, to come to agreement on a similar methodology to improve geographic evaluation and tracking of leaks to assist demonstrations of actual emissions reductions. Leak detection technology should be capable of transferring leak data to a central database in order to provide data for leak maps. Geographic leak maps shall be publicly available with leaks displayed by zip code or census tract.</p>		
PART 2: BEST PRACTICE DETAILS		
a) Historic work:		
<p>In the 2016 General Rate Case, SoCalGas requested to purchase 400 GIS-based Leak Survey trackers to enable surveyors to geo-tag the position of leaks as they are found. Upon further investigation, the IT support needed to implement this type of process with GIS needed to be developed before SoCalGas could implement geographic tracking of leaks. SoCalGas initiated a project through IT to develop the bread crumbing technology software support needed to implement geographic leak tracking. A summary of the project capabilities is below:</p>		
Functionality	Current State	Future State
Devices used for Leak Survey activities	Distribution currently uses mobile data terminals, transmission currently uses paper orders	Distribution and Transmission to use iPads for leak surveys
Maps of leak survey routes	Leak surveyors currently use paper maps	Distribution and Transmission will use electronic "maps" on tablets
Tracking of leak surveys	Currently manually bracket paper maps for tracking	GPS enabled tracking will be utilized, using breadcrumb technology enhancement to GIS
Tracking of potential leaks	Currently no integration to DP-IR / OMD, leaks are tracked manually	Bluetooth enabled Detecto Pak-Infrared units and Optical Methane Detector units will be integrated to tracking software, reducing manual data entry
Capturing Leak Indications, other Abnormal Operating Conditions, Business Districts changes & Encroachment Data	Currently limited integration between GIS Mobile and Click Mobile	Integration with mobile GIS solution providing more accurate X,Y location data for all field captured data
Maintenance plans and order generation	Currently maintenance plans support existing paper maps and orders	Maintenance plans to support new electronic maps and orders
Ability to track whether all pipeline assets have been appropriately Surveyed and all Leak Indications are captured appropriately.	Currently paper maps are reviewed manually. Limited or no integration with GIS in field.	Automated review of surveyed areas to improve ability to track whether pipeline assets have been appropriately surveyed. Tighter integration with GIS to better capture Leak Indications
Integration with Mobile Maximo Solution	Currently transmission uses paper orders in the field	Provide integration with Mobile Maximo Solution

Geographic maps of leaks are currently available on SoCalGas.com and have been since 2015. These maps are updated monthly and provide details regarding repair scheduling and leak status. The website for leak maps is <https://www.socalgas.com/stay-safe/methane-emissions/methane-emissions-map>

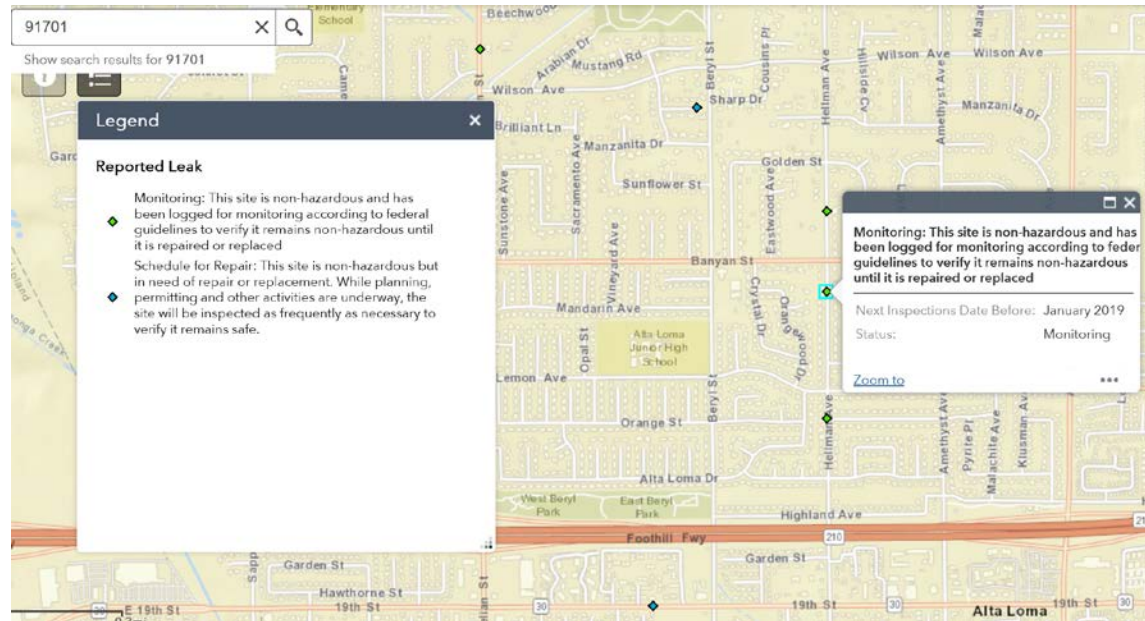

Figure 1: SoCalGas public-facing leak map webpage

b) Alternative Proposal to BP or exemption? No

No

c) Proposed Plan:

SoCalGas plans to implement a geographically tracked leak survey program that transfers leak data to a central database in order to provide data for leak maps. An incremental IT project is required to tie in the work management systems (e.g. Maximo, SAP), that will enable geographic tracking of leak survey compliance.

Also, to improve capabilities of leak surveys performed at storage facilities and compressor stations, SoCalGas is requesting incremental funding to back model these facilities in AVEVA. This will enable scanning technology on storage and compressor components so leak reporting is specific and can be audited. AVEVA is a system that enables engineering as-built 3D models of facilities. Having these modeling capabilities will make it easier to estimate emission volumes, tie leaks with supply management programs to order replacement parts when needed and identify lead times for replacement, and identify if leaks are on critical system which will influence plans for repair.

d) Overlap with other regulations? What portion of the BP is incremental beyond those regulations?

49 C.F.R. §192.723 (Distribution systems: Leakage surveys) requires SoCalGas to survey its gas distribution system for leakage. SoCalGas pipelines are typically leak surveyed at intervals of one, three, or five years. The frequency of this survey is determined by, among other things, the pipe material involved, the operating pressure, whether or not the pipe is under cathodic protection, identified threat, and the proximity of the pipe to various population densities. SoCalGas currently has approximately 100,000 miles of main and service pipeline requiring leak survey.

49 C.F.R. §192.706 (Transmission lines: Leakage surveys) requires SoCalGas to survey its gas transmission lines for leakages. SoCalGas transmission pipelines are typically leak surveyed at intervals of three, six or twelve months. The frequency of this survey is determined by class location.

e) What technology is required to implement the best practice and why?

Epoch is the vendor SoCalGas selected for GIS software development, iPads are the selected handheld hardware, and Bluetooth enabled DPIRs are already being used in the field.

f) Will work require additional personnel and/or contract support? If so, please provide details.

Contractors are currently working on developing the software package to enable leak survey tracking into GIS. Going forward SoCalGas is requesting 8 full time employees to manage this project. 2 full time employees are needed to support the system, one business analyst and one developer. Four employees will be needed to manage the leak tracking, the customer facing website, the modeling projects in AVEVA, data management, and instrument support. One trainer will be needed on a temporary basis for field training and one temporary for updating leak records into system.

g) What changes to existing operations are required? How will those changes be implemented?

Leak surveyors will carry iPads programmed with a software package to use GIS-generated leak survey routes instead of paper maps. Bluetooth enabled DPIRs and bread crumbing technology will be used to track leaks, and leak data will be electronically uploaded into GIS.

h) What are the new procedures to develop or existing procedures to modify? Please provide details.

The Gas Standards regarding leak survey procedures will need to be updated to reflect the new processes when they are in place.

i) Timeline for implementation (Milestones):

All milestones are listed are approximate and will vary based on when cost recovery is approved.

Milestones for geographic leak tracking project:

- iPad software components to be completed by the end of 2018
- SAP interface (Distribution) to be completed by the end of 2018
- Hardware purchase completed by end of 2018
- Maximo interface (Transmission) to be completed by Q2 of 2019
- Training to be completed by Q3 2019
- Full implementation is expected in Q4 of 2019

Milestone for AVEVA modeling:

- Statement of work and contract: 6 months
- IT infrastructure: 6 months
- Staff administrative and support team: 9 months
- Design tool application configuration: 9 months
- Complete modeling of one storage facility: 18 months
- Complete modeling of one compressor station: 18 months
- Complete modeling of all facilities: 45 months

j) Identify the range of factors or considerations used to determine cost-effectiveness of this measure, when costs estimates have been determined:

There is insufficient data to quantify emissions reductions from the activities in this Best Practice.

k) Identify any cost benefits from this BP, when cost estimates are known:

By identifying and tracking leaks using GIS technology, SoCalGas will improve efficiency of recording leaks, enable geographic tracking in real time, and will be able to coordinate leak repairs in a more efficient way. This project eliminates the need to print and review thousands of paper maps for distribution leak survey. The new system will improve the capture of Leak Indication and other Abnormal Operating Condition locational data, as well as improve the ability to track whether all pipelines have been appropriately surveyed or patrolled.

l) Do any incremental costs, if known, or benefits overlap with other BPs? If so, to which BP do they overlap, what are they, and how do they overlap?

The technology discussed here overlaps with BPs 15, 16, and 19 which require increased leak surveys.

m) Anticipated Emissions Reductions from this BP:

There is insufficient data to quantify emission reductions from the activities in this Best Practice.

2015 Baseline Emissions affected, where known:

There is insufficient data to quantify an emission baseline for the activities in this Best Practice.

n) Calculation Methodology:

N/A

o) Additional Comments: N/A
p) Overlap with Safety: SoCalGas anticipates an increase in safety resulting from technology improvements in tracking and recording leaks.
SUPPLEMENTAL INFORMATION
a) Technology:
b) Changes to Operations:
c) Research or Studies:
d) Other:

Best Practice 21: Find It, Fix It

2018 LEAK ABATEMENT COMPLIANCE PLAN TEMPLATE (D.17-06-015)

PART 1: OVERVIEW	
a) Best Practice: #21	b) Status: Work pending approval of AL 5211
Utilities shall repair leaks as soon as reasonably possible after discovery, but in no event, more than three (3) years after discovery. Utilities may make reasonable exceptions for leaks that are costly to repair relative to the estimated size of the leak.	
PART 2: BEST PRACTICE DETAILS	
a) Historic work: The SoCalGas Distribution Business Units implemented a targeted strategy to mitigate leaks from 2012-2016. This work was performed by prioritizing and performing main replacements on main segments identified to have both historical leakage as well as multiple leaks. This effort also focused on repairing leaks based on detection year and targeted the oldest leaks. Non-hazardous leaks were prioritized based on their potential to become hazardous and were repaired within 15 months or re-evaluated until their classification changed. Over the years, SoCalGas has accumulated an inventory of non-hazardous leak indications. SoCalGas made efforts to reduce this inventory. SoCalGas created a project management team in 2017, which centralized the leak inventory reduction effort to improve interdepartmental communications and hired leakage-focused crews to gain efficiency through leak repair repetition. The project management team tracks and manages the leak inventory by analyzing leak characteristics to determine the optimal process of addressing the inventory. Additionally, the team tracks the costs of leaks, field crew productivity, and communicates the leak inventory efforts to municipalities for awareness. The team focuses on eliminating these leaks in no more than three years from discovery to continue its reduction of the inventory as the level of work continues.	
b) Alternative Proposal to BP or exemption? No	
c) Proposed Plan: In 2019 SoCalGas plans to repair all code three steel leaks and above ground minor leaks discovered in 2016 or earlier. Going forward all code three steel leaks and above ground minor leaks will be repaired within three years. All other above ground leaks and leaks on buried pipe already require repairs be made before three years. Due to more frequent leak surveys at compressor stations and underground storage facilities, SoCalGas expects to document and repair an increased amount of minor above ground leaks. Repairs to minor leaks on high pressure systems may have significant	

impacts to operations such as critical systems being taken out of service, system availability, operational costs, and labor needs. These repairs may require incremental blowdowns and emissions from these blowdowns may negate any savings resulting from minor leak repair, unless reasonable exceptions apply.

For example, since the CARB Oil and Gas Rule went into effect on January 1, 2018, SoCalGas has discovered three areas with minor leaks that required immediate repair due to Leak Detection and Repair (LDAR) requirements.

Example 1: Two minor leaks were discovered on transmission line valves with an estimated combined emission of 56 MCF per year. The repair would require blowing down 11.4 miles of high pressure transmission pipeline and releasing an estimated 18,809 MCF.

Example 2: Two minor leaks were found on valve fittings on a transmission line with an estimated combined emission of 56 MCF per year. The repair would require blowing down 10.4 miles of high pressure transmission pipeline and releasing 37,398 MCF.

Example 3: Five minor leaks were found on a transmission line, 3 on pressure relief valves, one on a valve, and one on an elbow. The total estimated combined emissions for these minor leaks is 159 MCF per year. The repair would require blowing down 11.1 miles of high pressure transmission pipeline and releasing 17,136 MCF.

These situations are outlined to demonstrate that repair of minor leaks does not always result in an overall emission reduction. In each of these scenarios, it would take over 100 years of emissions from the minor leaks before they came anywhere near the emissions required for their repair. SoCalGas advocates for sensible policy and takes the position that these examples fall into the reasonable exception criteria. SoCalGas recommends a modification to the Annual Report Template to allow requests for reasonable exceptions to Best Practice 21 based on circumstances where leak repairs will cause incremental emissions or will be costly to repair compared with relative emissions. In these situations, repairs will be coordinated when they can be bundled with other required operational work.

d) Overlap with other regulations? What portion of the BP is incremental beyond those regulations?

This BP overlaps with Best Practices 15, 16, 18 and 19. Due to the increased leak surveys in Best Practices 15 and 16, SoCalGas expects to find more leaks, which in turn increases the number of leaks to be repaired as a result. The emission reductions for incremental leaks found in Best Practices 15, 16, 18, and 19 were accounted for in those respective compliance plans because it is difficult to separate the incremental leaks found because of increased surveys from the undiscovered leaks. The cost for the repairs is recorded in this best practice.

e) What technology is required to implement the best practice and why?

An IT project will be needed for SAP to update changes to compliance periods for leak repairs. SoCalGas estimates 200 hours of labor needed to update the coding that will trigger field employees to complete leak repairs prior to three-year requirement.

Vehicles and tools will be needed for incremental crews for leak repair.

f) Will work require additional personnel and/or contract support? If so, please provide details.

In 2019 SoCalGas will require seventeen incremental FTEs to manage distribution leak repair, three incremental FTEs for storage, and five incremental FTEs for transmission to manage the incremental work required. There will also be needs for contractor work for some leak repair projects.

g) What changes to existing operations are required? How will those changes be implemented?

The increased repair activity will take place using incremental FTEs. The operational procedures for making these repairs will not be changed. Required repairs will increase due to the policy change for minor above ground leaks repairs and code 3 steel leak repairs, as well as incremental leaks found due to increased leak surveys.

h) What are the new procedures to develop or existing procedures to modify? Please provide details.

Gas Standard 223.0125 will be revised to reflect new leaks to be repaired as soon as reasonably possible after discovery, but in no event, more than three (3) years after discovery. A red-lined version is attached with proposed updates.

Additionally, changes to the SAP Database and compliance requirements as well as reporting tools will be updated to align and adhere with the new SB 1371 compliance windows.

i) Timeline for implementation (Milestones):

All milestones are listed as the approximate length of time to completion from the date cost recovery is approved.

- Update gas standard and submitted for review: 2 months
- Policy change will be reviewed with field employees and field training: 4 months
- Gas standard will be published: 4 months
- Repair of leak inventory greater than three years: 24 months

j) Identify the range of factors or considerations used to determine cost-effectiveness of this measure, when costs estimates have been determined:

There is insufficient historical information on emissions associated with above-ground leaks.

Cost-effectiveness for leak repairs due to incremental leaks found due to increased leak surveys is accounted for in Best Practices 15 and 16.

Cost-effectiveness evaluations were generated by calculating the cumulative revenue requirement for activities that directly contribute to emissions reductions. The activity costs used to calculate the revenue requirement include the fully loaded and escalated capital investment and associated O&M, including on-going O&M over the useful life of the related capital asset, if applicable. The cumulative revenue requirement was divided by the total years of useful life to generate an average annual revenue requirement. Multiplying this annual average revenue requirement by 12 gives the estimated total cost of implementation for the SB 1371 program from 2018 through 2030.

Annual emissions reductions were compounded and summed to generate a total emissions reduction over the twelve-year program period.

Cost benefits were evaluated at the forecasted average annual WACOG published in the 2016 California Gas Report, converted to cost per MCF using a BTU conversion factor of 1.0343.

Cost-effectiveness is generated by dividing the cost of implementation less any cost benefits by estimated emission reduction.

Cost-Effectiveness for Performing Repairs on Code 3 Steel Leak Inventory

The average annual revenue requirement for Best Practice is \$17,134,336. Over the twelve-year period 2018-2030, the total revenue requirement is estimated at \$205,612,032.

Cost Benefits over the period from 2018-2030 are estimated at \$5,752,599. Details are in section K.

The compounded emissions reductions from 2018-2030 for this activity are estimated at 1,448,220 MCF. Details are in section M.

Overall cost-effectiveness = $(\$205,612,032 - \$5,752,599) / 1,448,220 \text{ MCF} = \$138/\text{MCF}$

k) Identify any cost benefits from this BP, when cost estimates are known:

The cost of gas saved by reducing emissions is estimated at \$5,752,599 over 2018-2030. Cost benefits were evaluated at the forecasted average annual WACOG published in the 2016 California Gas Report, converted to cost per MCF using a BTU conversion factor of 1.0343.

Year	WACOG (\$/MCF)	Reduced Emission	Cost Benefits
2019	\$2.664188	120,685	\$321,528
2020	\$2.649745	120,685	\$319,784
2021	\$2.986593	120,685	\$360,437
2022	\$3.475680	120,685	\$419,462
2023	\$3.743690	120,685	\$451,807
2024	\$3.952100	120,685	\$476,959
2025	\$4.224613	120,685	\$509,847
2026	\$4.525677	120,685	\$546,181
2027	\$4.624728	120,685	\$558,135
2028	\$4.734834	120,685	\$571,423
2029	\$4.944888	120,685	\$596,774
2030	\$5.139493	120,685	\$620,260

l) Do any incremental costs, if known, or benefits overlap with other BPs? If so, to which BP do they overlap, what are they, and how do they overlap?

Incremental costs for repairing leaks found due to increased leak surveys required by Best Practices 15, 16, 18 and 19 are included in this best practice.

m) Anticipated Emissions Reductions from this BP:

SoCalGas projects repairing the inventory of code three steel leaks will reduce emissions by 1,448,220 MCF over 2018-2030 based on historical analysis.

Year	Year-of emissions reductions (MCF)	Compounded Emissions Reductions (MCF)
2019	120,685	120,685
2020	120,685	241,370
2021	120,685	362,055
2022	120,685	482,740
2023	120,685	603,425
2024	120,685	724,110
2025	120,685	844,795
2026	120,685	965,480
2027	120,685	1,086,165
2028	120,685	1,206,850
2029	120,685	1,327,535
2030	120,685	1,448,220

Emissions reduction from additional leaks found because of Best Practices 15, 16, 18 and 19 are captured in those Best Practices using the criteria that repairs are made within 6 months which is the current average leak repair time.

There is insufficient historical data to estimate emissions reductions for repairing above ground leaks at transmission and storage. SoCalGas does not have the historical information necessary to calculate the portion of emissions that are associated with minor leaks.

2015 Baseline Emissions affected, where known:

The 2016 baseline for below-ground leakage is 548,653 MCF.

n) Calculation Methodology:

The reduction was calculated by estimating emissions from reported existing leaks that were discovered prior to 2013.

o) Additional Comments:

p) Overlap with Safety:

Leak repairs are currently performed to meet safety standards prescribed in 49 CFR 192. All repairs required by this Best Practice are incremental to safety requirements.

SUPPLEMENTAL INFORMATION

a) Technology:

b) Changes to Operations:

The accompanying attachments have been redacted to remove non-responsive, non-relevant employee information.

Attachment O: Red-lined draft of Gas Standard 223.0125

c) Research or Studies:

d) Other:

Best Practice 22: Pipe Fitting Specifications

2018 LEAK ABATEMENT COMPLIANCE PLAN TEMPLATE (D.17-06-015)

PART 1: OVERVIEW	
a) Best Practice: #22	b) Status: Work pending approval of AL 5211
<p>Companies shall review and revise pipe fitting specifications, as necessary, to ensure tighter tolerance/better quality pipe threads. Utilities are required to review any available data on its threaded fittings, and if necessary, propose a fitting replacement program for threaded connections with significant leaks or comprehensive procedures for leak repairs and meter set assembly installations and repairs as part of their Compliance Plans. A fitting replacement program should consider components such as pressure control fittings, service tees, and valves metrics, among other things.</p>	
PART 2: BEST PRACTICE DETAILS	
<p>a) Historic work: SoCalGas has a supply management department that work with vendors to specify requirements for all components. When equipment is received it is inspected at a warehouse facility to verify requirements are met. If there are any concerns regarding the quality of products, including the threaded components and fittings, the supply management department is engaged to correct the issue and either engage the current vendor to increase quality assurance standards or to begin contract negotiations with alternative vendors to confirm all concerns are addressed.</p> <p>SoCalGas estimates emissions from threaded components by multiplying a facility count by an emissions factor. Because SoCalGas has so many meters, any emissions from threaded fittings on meter set assemblies has a significant impact on total emissions.</p>	
<p>b) Alternative Proposal to BP or exemption? No</p>	
<p>c) Proposed Plan: SoCalGas is commissioning a research project to quantify and identify opportunity for reducing emissions from threaded components to investigate opportunities for emission reduction and identify if improving thread quality will reduce emissions from threaded fittings. If an opportunity exists to reduce emissions by improving thread count, SoCalGas will provide an updated proposal in the 2020 compliance plan.</p> <p>SoCalGas is partnering with other utilities for an SB 1371 research project via NySearch to begin a comprehensive analysis of methane emissions through threaded components of MSAs and regulator stations. This study is to begin by the end of first quarter 2018.</p>	

SoCalGas also plans to increase receiving inspection of threaded components used for Meter Set Assemblies (MSA) to improve assurance of compliance to pipe thread specification. SoCalGas will work with component manufacturers to align gaging practices and manufacturing process controls to maintain a high standard of pipe thread quality for products intended for use in Natural Gas applications. Review company material specifications (MSP) and revise, if necessary to specify consistent requirements across component categories.

d) Overlap with other regulations? What portion of the BP is incremental beyond those regulations?

N/A

e) What technology is required to implement the best practice and why?

No technology is required at this time.

f) Will work require additional personnel and/or contract support? If so, please provide details.

Yes, SoCalGas is partnering with other utilities to commission a research project through NySearch to identify emissions reductions through threaded MSA components.

Estimated three additional personnel will be needed. Two supply management FTEs to support additional quality control of incoming threaded materials and one incremental engineer to support material specification modifications and work with manufacturers.

g) What changes to existing operations are required? How will those changes be implemented?

SoCalGas plans to increase receiving inspection of threaded components used for Meter Set Assemblies (MSA) to improve assurance of compliance to pipe thread specification. SoCalGas will work with component manufacturers to align gaging practices and manufacturing process controls to maintain a high standard of pipe thread quality for products intended for use in Natural Gas applications. Review Company material specifications (MSP) and revise, if necessary to specify consistent requirements across component categories.

h) What are the new procedures to develop or existing procedures to modify? Please provide details.

No procedure changes are required for the activities proposed in this Best Practice

i) Timeline for implementation (Milestones):

All milestones are listed as the approximate length of time to completion from the date cost recovery is approved.

- The research project is expected to begin by the end of first quarter 2018 and will be completed by the end of 2019.
- Hire and train incremental employees: 9 months

- Implement receiving inspection process: 9 months
- Update material specs, if necessary: 18 months

j) Identify the range of factors or considerations used to determine cost-effectiveness of this measure, when costs estimates have been determined:

SoCalGas is unable to estimate emission reductions for this Best Practice due to insufficient historical emissions information and therefore cannot estimate cost-effectiveness at this time. The proposed research projects will help identify what opportunities are available for emissions reductions in this. By cost-sharing research projects with other utilities through NYSEARCH, SoCalGas has minimized the impact to customers.

k) Identify any cost benefits from this BP, when cost estimates are known:

There is insufficient data to estimate cost benefits from the activities in this Best Practice.

l) Do any incremental costs, if known, or benefits overlap with other BPs? If so, to which BP do they overlap, what are they, and how do they overlap?

N/A

m) Anticipated Emissions Reductions from this BP:

SoCalGas is unable to estimate emission reductions for this Best Practice due to insufficient historical emissions information. Potential for emission reductions will be reevaluated based on results from the proposed research projects.

2015 Baseline Emissions affected, where known:

N/A

n) Calculation Methodology:

N/A

o) Additional Comments:

N/A

p) Overlap with Safety:

N/A

SUPPLEMENTAL INFORMATION

a) Technology:
b) Changes to Operations:
c) Research or Studies:
d) Other:

Best Practice 23: Minimize Emissions from Operations, Maintenance, and Other Activities

2018 LEAK ABATEMENT COMPLIANCE PLAN TEMPLATE (D.17-06-015)

PART 1: OVERVIEW	
a) Best Practice: #23	b) Status: Work pending approval of AL 5211
<p>Utilities shall minimize emissions from operations, maintenance and other activities, such as new construction or replacement, in the gas distribution and transmission systems and storage facilities. Utilities shall replace high bleed pneumatic devices with technology that does not vent gas (i.e. no-bleed) or vents significantly less natural gas (i.e. low-bleed) devices. Utilities shall also reduce emissions from blowdowns, as much as operationally feasible.</p>	
PART 2: BEST PRACTICE DETAILS	
a) Historic work:	
<p>SoCalGas became a founding member of The EPA Natural Gas STAR Program in 1993. Through this program, SoCalGas has implemented methane reducing technologies and practices and documented voluntary emission reduction activities. SoCalGas continuously evaluates methane emission reduction opportunities, implements cost-effective methane reduction projects where feasible, and annually reports methane emission reduction actions to the EPA. Total savings by SoCalGas through implementation of methane reduction practices between 1993 and 2016 were 2,620,910,000 cubic feet of methane.</p> <p>SoCalGas has long recognized the need to voluntarily reduce methane emissions. The company has contributed to the elimination of methane emissions by employing several different best practices in both sectors combined as follows:</p> <ul style="list-style-type: none"> • <u>Directed Inspection & Maintenance (DI&M)</u>; A DI&M program concentrates on components that are prone to leak enough methane to make repairs cost-effective. Such components include valve packing, pneumatic controllers and open-ended lines such as vent and drain connections, blowdown lines, pneumatic engine starter motors, and pressure relief valves.⁵⁶ • <u>Identify and rehabilitate leaky distribution pipe</u>; Through regular leak surveys, SoCalGas has identified and repaired or replaced pipeline with high leak rates. • <u>Replace compressor rod packing systems</u>; Reciprocating compressors in the natural gas industry leak natural gas during normal operation. Areas of high leak frequency include 	

⁵⁶ "Conduct Directed Inspection and Maintenance at Remote Sites." *EPA.gov*, 2011, www.epa.gov/natural-gas-star-program/conduct-directed-inspection-and-maintenance-remote-sites.

flanges, valves, and fittings located on compressors. The highest volume of gas loss, however, is associated with piston rod packing systems. Packing systems are used to maintain a tight seal around the piston rod, preventing the gas compressed to high pressure in the compressor cylinder from leaking, while allowing the rod to move freely. Compressor rod packing consists of a series of flexible rings that fit around the shaft to create a seal against leakage. Packing rings are held in place by a set of packing cups, normally one for each pair of rings, and kept tight against the shaft by a surrounding spring. A “nose gasket” on the end of the packing case prevents leaks around the packing cups. Leaking gases are vented to the atmosphere through packing vents on the flange. Leakage can be reduced through proper monitoring and a cost-effective schedule for replacing packing rings and piston rods. New ring materials and new designs for packing cases are emerging that should reduce emissions in the future.⁵⁷

- Reduce system pressure for maintenance blowdowns; Operators of natural gas pipeline systems routinely reduce line pressure and discharge gas from pipeline sections to provide safe working conditions during maintenance and repair activities. Typically, operators block the smallest possible linear section of the pipeline and depressurize it by venting gas to the atmosphere. Using pump-down techniques to lower gas line pressure before performing maintenance and repair activities is an effective way to reduce emissions and yield significant economic savings. Pipeline pump-down techniques involve using in-line compressors either alone or in sequence with portable compressors. Using in-line compressors is generally justifiable because there are no capital costs, and payback is immediate. The cost-effectiveness of also using a portable compressor to increase gas recovery, however, depends greatly on site-specific factors and operating costs. Regardless of the pump-down technique selected, emission reductions are directly proportional to how much pipeline pressure is reduced before venting occurs. Pipeline pump-down techniques are most economical for larger volume, higher pressure gas lines and work most effectively for planned maintenance activities and cases in which sufficient manifolding exists to connect a portable compressor.⁵⁸
- Redesign blowdown process in Emergency Shutdown practices; Compressors are used throughout the natural gas industry to move natural gas from production and processing sites to customer distribution systems. Compressors must periodically be taken off-line for maintenance, operational stand-by, or emergency shut down testing, and as a result, methane may be released to the atmosphere from a number of sources. When compressor units are shut down, typically the high pressure gas remaining within the compressors and associated piping between isolation valves is vented to the atmosphere (blowdown) or to a flare. In addition to blowdown emissions, a depressurized system may continue to leak gas from faulty or improperly sealed unit isolation valves. Some changes in operating practices and in the design of blowdown systems can save money and significantly reduce methane blowdown valve and from reciprocating compressor rod packing, total emissions can be significantly reduced. Four options for reducing emissions when taking compressors off-line include:
 - Keeping compressors pressurized when off-line.

⁵⁷ “Reducing Methane Emissions From Rod Packing Systems.” *EPA.gov*, Natural Gas Star Partners, Oct. 2006, www.epa.gov/sites/production/files/2016-06/documents/ll_rodpack.pdf.

⁵⁸ “Using Pipeline Pump-Down Techniques.” *Environmental Protection Agency*, Natural Gas STAR Partners, Oct. 2006. https://www.epa.gov/sites/production/files/2016-06/documents/ll_pipeline.pdf

- Connecting blowdown vent lines to the fuel gas system and recovering all, or a portion, of the vented gas to the fuel gas system.
- Installing static seals on compressor rod packing.
- Installing ejectors on compressor blowdown vent lines.

Keeping compressors fully pressurized when off-line achieves immediate payback—there are no capital costs and emissions are avoided by reducing the net leakage rate. Routing blowdown vent lines to the fuel gas system or to a lower pressure gas line reduces fuel costs for the compressor or other facility equipment, in addition to avoiding blowdown emissions. Static seals installed on compression rods eliminate gas leaking back through the rod packing while a compressor is shutdown under pressure. An ejector uses the discharge of an adjacent compressor as motive to pump blowdown or leaked gas from a shut down compressor into the suction of an operating compressor or a fuel gas system. Benefits of these practices include fewer bulk gas releases, lower leak rates, and lower fuel costs, with a payback in most cases of less than a year.⁵⁹

This best practice affects many areas of operations at SoCalGas, as minimizing emissions from operations has a wide scope for implementation. The following categories are areas in which SoCalGas has identified opportunity to implement additional activities to reduce emissions:

- a. Blowdown reduction: SoCalGas has documented use of cost effective methods to reduce blowdown since 1993 during operations on high pressure construction projects. Attached is a presentation by Deanna Haines referencing the various practices used by SoCalGas to reduce blowdown emissions, including pressure reduction using mobile compressors, transfer of gas to lower pressure systems, and isolation of sections using stopples.⁶⁰ These activities are in line with EPA Natural Gas STAR Best Practices to reduce methane emissions. Operators of natural gas pipeline systems routinely reduce line pressure and discharge gas from pipeline sections to provide safe working conditions during maintenance and repair activities. Typically, operators block the smallest possible linear section of the pipeline and depressurize it by venting gas to the atmosphere. Using pump-down techniques to lower gas line pressure before performing maintenance and repair activities is an effective way to reduce emissions and yield significant economic savings. Pipeline pump-down techniques involve using in-line compressors either alone or in sequence with portable compressors. Using in-line compressors is generally justifiable because there are no capital costs, and payback is immediate. The cost-effectiveness of also using a portable compressor to increase gas recovery, however, depends greatly on site-specific factors and operating costs. Regardless of the pump-down technique selected, emission reductions are directly proportional to how much pipeline pressure is reduced before venting occurs. Pipeline pump-down techniques

⁵⁹ “Reducing Emissions When Taking Compressors Off-Line.” *Environmental Protection Agency*, Natural Gas STAR Partners, Oct. 2006, www.epa.gov/sites/production/files/2016-06/documents/ll_compressoroffline.pdf.

⁶⁰ Haines, Deanna. *Technology Transfer workshop: Pipeline Blowdowns in Transmission and Distribution*. Southern California Gas Company and San Diego Gas & Electric, 10 Nov. 2016.

are most economical for larger volume, higher pressure gas lines and work most effectively for planned maintenance activities and cases in which sufficient manifolding exists to connect a portable compressor.³

- b. **Pneumatic Devices:** SoCalGas has been addressing the replacement of high-bleed pneumatic devices since 1993 through the EPA Natural Gas STAR Best Practice and has targeting the higher emission projects, requesting cost recovery for the replacement of some of the more cost effective high bleed pneumatic device projects through the General Rate Case (GRC). Pneumatic devices powered by pressurized natural gas are used widely in the natural gas industry as pressure regulators and valve controllers. Methane emissions from pneumatic devices are one of the largest sources of vented methane emissions from the natural gas industry. Reducing these emissions by replacing high-bleed devices with low-bleed devices, retrofitting high-bleed devices, and improving maintenance practices can be cost-effective. Individual savings will vary depending on the design, condition and specific operating conditions of the controller. As part of normal operation, pneumatic devices release or bleed natural gas to the atmosphere and, consequently, are a major source of methane emissions from the natural gas industry. The actual bleed rate or emissions level largely depends on the design of the device.

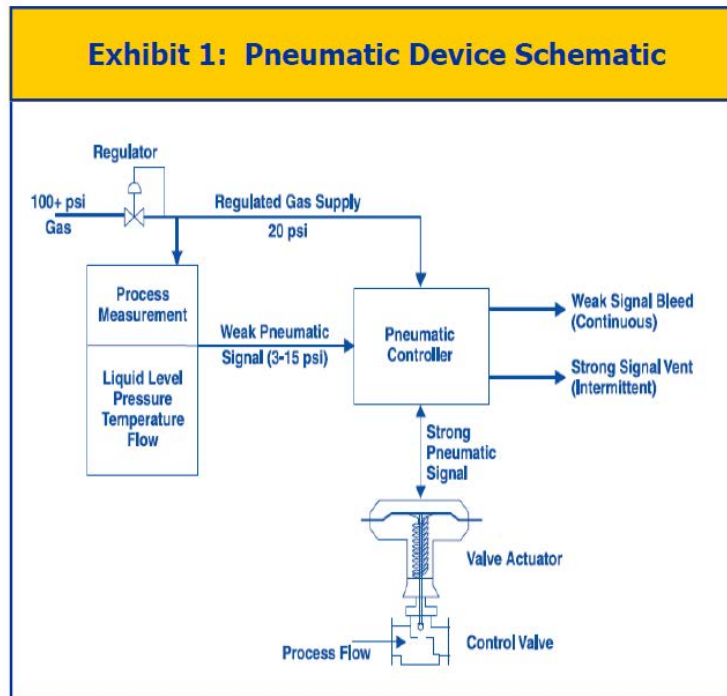

Figure 2: Pneumatic Device Schematic⁶¹

Exhibit 1 shows a schematic of a gas pneumatic control system. Clean, dry, pressurized natural gas is regulated to a constant pressure. This gas supply is used both as a signal and a power supply. A small stream is sent to a device that measures a process condition (gas pressure, flow, temperature). This device regulates the pressure of this small gas stream in proportion to the process condition. The stream flows to the pneumatic valve controller, where its variable pressure is used to regulate a valve actuator. To close the valve pictured in Exhibit 1, 20-psig pneumatic gas is directed to the actuator, pushing the diaphragm down against the spring, which, through the valve stem, pushes the valve plug closed. When gas is

vented off the actuator, the spring pushes the valve back open. The weak signal continuously vents (bleeds) to the atmosphere. Pneumatic devices come in three basic designs:

- **Continuous** bleed devices are used to modulate pressure and will generally vent gas at a steady rate
- **Actuating or intermittent** bleed devices perform snap-acting control and release gas only when they stroke a valve open or closed or as they throttle gas flows
- **Self-contained** devices release gas into the downstream pipeline, not to the atmosphere

To reduce emissions from pneumatic devices the following options can be pursued, either alone or in combination:

- Replacement of high-bleed devices with low-bleed devices having similar performance capabilities.
- Installation of low-bleed retrofit kits on operating devices.
- Enhanced maintenance, cleaning and tuning, repairing/replacing leaking gaskets, tubing fittings, and seals.

In general, the bleed rate will also vary with the pneumatic gas supply pressure, actuation frequency, and age or condition of the equipment. Due to the need for precision, controllers that must operate quickly will bleed more gas than slower operating devices. The condition of a pneumatic device is a stronger indicator of emission potential than age; well-maintained pneumatic devices operate efficiently for many years.⁶¹

- c. Meter replacement policy: Historically, if a meter failed the Meter Performance Control Program, an internal meter performance standard at SoCalGas, that meter would be replaced as Planned Meter Change (PMC). The number of meters that require replacement varies, but SoCalGas data indicates it will be replacing 80,000 meters annually due to calibration tolerance. Associated emissions are roughly 1 to 6 SCF for small to large meter replacement, resulting from methane escape during the replacement operation.
- d. Differential Pressure Testing of Rotary Meters: SoCalGas is currently required to perform accuracy testing on rotary meters by Resolution G-3257, attached. Performing this accuracy test emits roughly five cubic feet of natural gas per test. SoCalGas tests about 250 rotary and diaphragm meters annually. Differential Pressure Testing is an alternative method to test for meter accuracy, which has zero emissions.
- e. Vapor Recovery Systems In lieu of Rod-Packing Replacements: SoCalGas has historically used rod packing replacement at compressor stations as a good way to reduce emissions through the EPA Natural Gas STAR Program since 1993. However, the emission reductions achievable through this practice and the longevity of those reductions has not been documented or verified for the compressor stations operated by SoCalGas. Savings documented by utilities varies by operational situation and new data and evidence may influence the cost-effectiveness of this best practice. Reciprocating compressors in the natural gas industry leak natural gas

⁶¹ "Options For Reducing Methane Emissions From Pneumatic Devices In The Natural Gas Industry." Environmental Protection Agency, Natural Gas STAR Partners, Oct. 2006, www.epa.gov/sites/production/files/2016-06/documents/ll_pneumatics.pdf.

during normal operation. Areas of high leak frequency include flanges, valves, and fittings located on compressors. The highest volume of gas loss, however, is associated with piston rod packing systems. Packing systems are used to maintain a tight seal around the piston rod, preventing the gas compressed to high pressure in the compressor cylinder from leaking, while allowing the rod to move freely. Compressor rod packing consists of a series of flexible rings that fit around the shaft to create a seal against leakage. Packing rings are held in place by a set of packing cups, normally one for each pair of rings, and kept tight against the shaft by a surrounding spring. A “nose gasket” on the end of the packing case prevents leaks around the packing cups. Leaking gases are vented to the atmosphere through packing vents on the flange. Leakage can be reduced through proper monitoring and a cost-effective schedule for replacing packing rings and piston rods. New ring materials and new designs for packing cases are emerging that should reduce emissions in the future.²

- f. Research, Design, & Demonstration (RD&D): SoCalGas has a comprehensive RD&D department focused on identifying opportunity for operational improvements and reduced environmental impact. SoCalGas partners with other utilities, California Air Resources Board (CARB), California Energy Commission (CEC), and Environmental Protection Agency (EPA) to develop state of the art research projects to stay up to date on new technological capabilities regarding methane emission reduction.

b) Alternative Proposal to BP or exemption? No

c) Proposed Plan:

- a) Blowdown reduction: In addition to continuing using existing methods of blowdown reduction like cross-compression, pipeline pump-down, and isolation as described in the historical work section, SoCalGas proposes to capture blowdown gas into Compressed Natural Gas (CNG) pods or trailers. This methane capture system utilizes a mobile compressor to compress pipeline gas into a CNG trailer. The gas is then re-introduced into the pipeline when operation is completed. This method of capturing gas into CNG canisters was first trialed through the Pipeline Safety Enhancement Project (PSEP) and SoCalGas is proposing to expand this activity through SB 1371 with the goal of further reducing emissions. SoCalGas will also be implementing a system to coordinate pipeline projects across departments to perform all work with one blowdown. There are limitations to this practice such as compliance timelines to meet certain objectives and urgency of some projects. SoCalGas has identified 7 possible projects in 2018 and 38 possible projects scheduled for 2019 where methane capture can be accomplished. SoCalGas is also exploring opportunities for blowdown capture in storage.
- b) Pneumatic Devices: SoCalGas has seventy high-bleed pneumatic devices in operation, all of which are on a replacement schedule between 2018 and 2022. SoCalGas proposes replacing 8 high bleed pneumatic devices in 2018 and 8 in 2019. These projects are incremental to two large replacement projects requested in the 2019 GRC to be completed in 2019. Remaining high bleed pneumatic devices will be addressed in future compliance plans.
- c) Meter replacement policy: To reduce emissions, SoCalGas recommends using a billing calibration adjustment factor rather than replacing meters that would require replacement under the PMC. By keeping the meters in place and applying a billing calibration adjustment factor, there will be no emissions resulting from meter replacements.

- d) Differential Pressure Testing of Rotary Meters: SoCalGas proposes updating policies to use DP for accuracy testing instead of performing accuracy testing in the meter shop. Differential Pressure Testing (DP) is an alternative method to test for meter accuracy, which has zero emissions. All SoCalGas rotary meters have Pete's plugs - self-sealing plugs that allow technicians to insert a DP connection with little to no gas escaping.
- e) Vapor Recovery Systems In lieu of Rod-Packing Replacements: SoCalGas proposes installing vapor recovery systems at compressor stations to capture methane emissions. The emission reductions achievable through rod packing replacement and the longevity of those reductions has not been documented or verified for the compressor stations operated by SoCalGas. Savings documented by utilities varies by operational situation and new data and evidence may influence the cost-effectiveness of this best practice. SoCalGas proposes collecting emissions data from compressor rod packing systems needed to size vapor recovery systems. SoCalGas plans to begin designing and installing vapor recovery systems in 2018 with a goal of three installations by the end of 2019. Remaining systems will be included in the next Compliance Plan.
- f) RD&D: SoCalGas has two research projects related to this Best Practice:
- o Develop Methods to Mitigate Gas Blown to Atmosphere Research Project (OTD 5.16.n) Investigate traditional planned blowdown procedures of venting natural gas to the atmosphere and compare them to alternative methods such as flaring and re-capture of the blowdown gas, to determine viable options. Assessment includes environmental impacts.
 - o Methane Oxidation Catalyst Research Project (NYSEARCH) Design and test novel catalytic materials for low-temperature methane oxidation (combustion – thermal oxidizer) as an alternative to flaring of pipeline gas.

d) Overlap with other regulations? What portion of the BP is incremental beyond those regulations?

The proposed vapor recovery system supports CARB Oil and Gas Rule. **Error! Bookmark not defined.**

Local Air Districts may be considering additional regulations that may cover this area.

e) What technology is required to implement the Best Practice and why?

- a) Blowdown reduction: Gas compressors, CNG pods and trailers, and portable generators are needed for CNG capture blowdown reduction.



Figure 3: CNG Capture portable generator, mobile compressor, and CNG trailer⁶⁰

- b) Pneumatic Devices: Low bleed or no bleed pneumatic devices are needed to replace existing high bleed devices

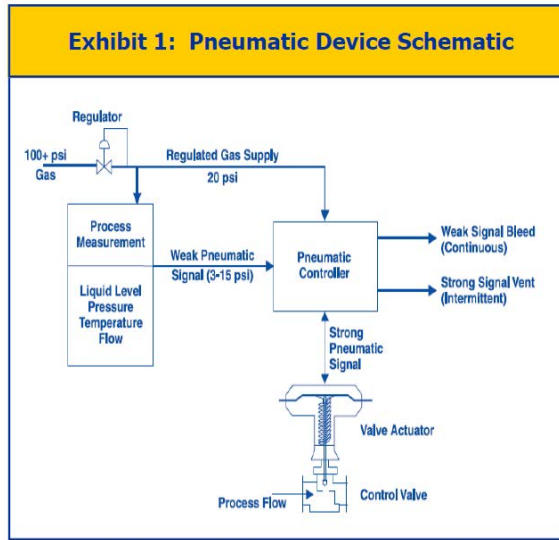

Figure 4: Pneumatic Device Schematic⁶¹

- c) Meter replacement policy: This will require an IT adjustment to update billing processes
 d) Differential Pressure Testing of Rotary Meters: Differential pressure testing requires instrumentation that connects to Pete's plug for quick pressure tests.



Figure 5: Differential pressure test using pete's plug⁶²

- e) Vapor Recovery Systems In lieu of Rod-Packing Replacements: Vapor recovery systems.

⁶²“It Starts With the Connection....” *It Starts With the Connection.... Petro Online*, www.petro-online.com/news/flow-level-pressure/12/ralston-instruments/it-starts-with-the-connectionhellip/42400.

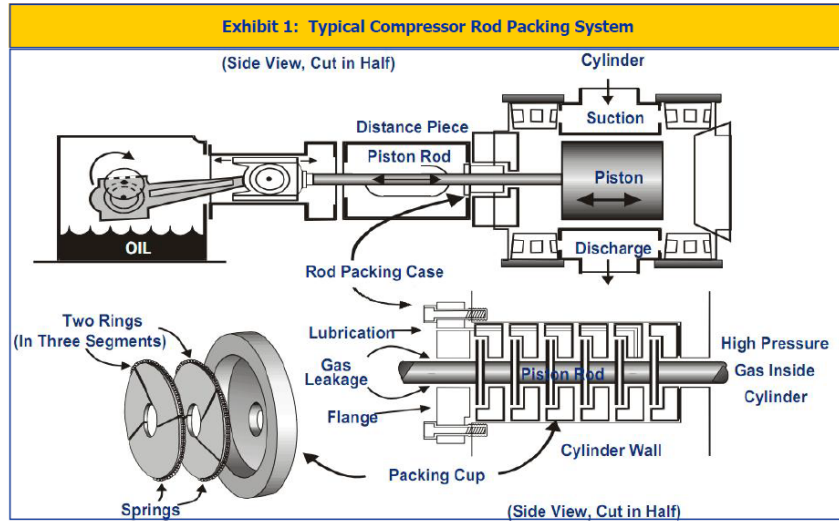
Figure 6: Typical Compressor Rod Packing System²f) RD&D: Various catalytic materials, rod packing assemblies

Methane Oxidation

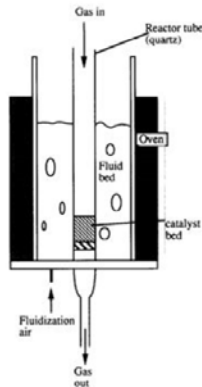

Figures adapted from Veldsink et al.

Physical properties of the catalyst material and reaction system

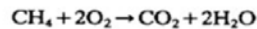

$$\Delta H_r = -8.03 \times 10^5 \text{ (J mol}^{-1}\text{)}$$

$$D_{\text{ethane, air}}^0 = 0.88 \times 10^{-4} \text{ (m}^2 \text{ s}^{-1}\text{, at 773 K, 0.13 MPa)}$$

$$D_{\text{oxygen, air}}^0 = 1.08 \times 10^{-4} \text{ (m}^2 \text{ s}^{-1}\text{, at 773 K, 0.13 MPa)}$$

$$\lambda_{\text{cat}} = \lambda_{\gamma\text{-alumina}} \approx 8 \text{ (W m}^{-1} \text{ K}^{-1}\text{)}$$

$$\epsilon_{\text{bed}} = 0.43$$

$$D_{Z-A}^{\text{eff}} = 0.1D_A$$

$$r_p = 7.2 \times 10^{-9} \text{ (m)}$$

$$\rho_{\text{cat}} = 1040 \text{ (kg m}^{-3}\text{)}$$

$$V_{\text{pore}} = 0.78 \text{ (cm}^{-3} \text{ g}^{-1}\text{)}$$

$$\text{Area} = 163.6 \text{ (m}^2 \text{ g}^{-1}\text{)}$$

Figure 7: Methane oxidation to carbon dioxide⁶³

f) Will work require additional personnel and/or contract support? If so, please provide details.

- 2 Project Managers for Transmission, Starting in 2018
- 1 Project Manager for Storage, Starting in 2019
- 2 Project Managers Distribution, Starting in 2019
- 2 OpQual Instructors
- 6 engineers for organization to centrally manage gas capture operations and coordinate combining projects to reduce blowdowns

⁶³ Chambers, Magdalene. "Reaction Kinetics of Methanol Synthesis." *SlidePlayer*, 28 Aug. 2017, slideplayer.com/slide/4905924/.

g) What changes to existing operations are required? How will those changes be implemented?

- a) Blowdown reduction: In addition to continuing using existing methods of blowdown reduction like cross-compression, pipeline pump-down, and isolation as described in the historical work section, SoCalGas proposes to capture blowdown gas into CNG pods or trailers. This methane capture system utilizes a mobile compressor to compress pipeline gas into a Compressed Natural Gas (CNG) trailer. The gas is then re-introduced into the pipeline when operation is completed. This method of capturing gas into CNG canisters was first trialed through the Pipeline Safety Enhancement Project (PSEP) and SoCalGas is proposing to expand this activity through SB 1371 with the goal of further reducing emissions. SoCalGas will combine work on high pressure lines when it is practical to do so and will coordinate projects across departments. Gas Standards will need to be developed to implement these changes.
- b) Pneumatic Devices: N/A
- c) Meter replacement program: Meters will be kept in service and a billing calibration adjustment factor will be applied to customer bills.
- d) Differential Pressure Testing of Rotary Meters: M&R technicians will begin testing meter accuracy on rotary and diaphragm meters using differential pressure testing.
- e) Vapor Recovery In lieu of Rod Packing: Vapor recovery systems will capture methane emissions from compressors, reducing O&M on rod packing units.
- f) RD&D: N/A

h) What are the new procedures to develop or existing procedures to modify? Please provide details.

- a) Blowdown reduction: Gas Standards will need to be developed to implement these changes. Updated gas standards reflecting blowdown reduction are captured in Best Practices 3-8.
- b) Pneumatic Devices: N/A
- c) Meter replacement policy: Modifications will need to be made to GO 58A
- d) Differential Pressure Testing of Rotary Meters: Modifications will be needed to Resolution G-3257
- e) Vapor Recovery In lieu of Rod Packing Replacements: N/A
- f) RD&D: N/A

i) Timeline for implementation (Milestones):

All milestones are listed as the approximate length of time to completion from the date cost recovery is approved.

- Blowdown reduction:
 - Begin capturing gas from blowdowns via CGN trailers: full implementation 6 months after cost recovery approval to develop internal policies and train employees
- Pneumatic Devices:
 - After cost recovery is approved, construction will be scheduled to replace pneumatic devices which will be prioritized based on cost-effectiveness emissions reduction opportunity. Assuming approval at the end of second quarter 2018, SoCalGas anticipates being able to complete 8 replacements in 2018 and 8 replacements in

2019, in addition to the replacements requested through the General Rate Case Application.

- Remaining replacement projects are staggered through 2022
- Meter replacement policy:
 - Draft and review policy change: 3 months
 - Develop training for field employees: 4 months
 - Train employees on policy change to meter replacement policy: 9 months
 - Develop IT updates to reflect policy changes: 12 months
 - Publish policy changes: 12 months
 - Full implementation: 12 months
- Differential Pressure Testing of Rotary Meters:
 - Draft and review policy change: 3 months
 - Develop training for field employees: 4 months
 - Train employees on policy change to meter replacement policy: 9 months
 - Develop IT updates to reflect policy changes: 12 months
 - Publish policy changes: 12 months
 - Full implementation: 12 months
- Vapor Recovery Systems In lieu of Rod Packing Replacements:
 - Gather data to size vapor recovery units: 6 months
 - Generate design scope: 6 months
 - Install vapor recovery systems: 12-24 months
- RD&D Projects:
 - *Develop Methods to Mitigate Gas Blown to Atmosphere Research Project (OTD 5.16.n)*
 - Project Start Date – 8/1/2016
 - Anticipated End Date – 3/31/2018
 - *Methane Oxidation Catalyst Research Project (NYSEARCH)*
 - Project Start Date – 10/1/2017
 - Anticipated End Date – 3/31/2019

j) Identify the range of factors or considerations used to determine cost-effectiveness of this measure, when costs estimates have been determined:

- a) Blowdown reduction: Assumptions for emissions reductions for blowdown include an average blowdown of 2,865 MCF per event, which was the average over years 2016-2017. It also assumed an average reduction of 70% when blowdown capture is performed, and that opportunities for blowdown reduction will remain constant over years 2018-2030. Several variables affect if blowdown capture is an option, including system capacity issues, location of operation, permitting availability, timeline and urgency of operation, locations of valving, customer impact, weather, and availability of compressors and CNG trailers. If blowdown reduction is an option, variables affecting the volume of emission reduction include line pressure, pipe diameter, length of pipe being blown down, and duration of event.

Cost-effectiveness evaluations were generated by calculating the cumulative revenue requirement for activities that directly contribute to emissions reductions. The activity costs used to calculate the revenue requirement include the fully loaded and escalated capital investment and associated O&M, including on-going O&M over the useful life of the related

capital asset, if applicable. The cumulative revenue requirement was divided by the total years of useful life to generate an average annual revenue requirement. Multiplying this annual average revenue requirement by 12 gives the estimated total cost of implementation for the SB 1371 program from 2018 through 2030.

Annual emissions reductions were compounded and summed to generate a total emissions reduction over the twelve-year program period.

Cost benefits were evaluated at the forecasted average annual WACOG published in the 2016 California Gas Report, converted to cost per MCF using a BTU conversion factor of 1.0343.

Cost-effectiveness is generated by dividing the cost of implementation less any cost benefits by estimated emission reduction.

Cost-Effectiveness for Blowdown Reduction

The average annual revenue requirement for this Best Practice is \$9,217,398. Over the twelve-year period, 2018-2030, the total revenue requirement is estimated at \$110,608,776.

Cost Benefits over the period from 2019-2030 are estimated at \$2,150,891. Details are in section K.

The compounded emissions reductions from 2018-2030 for this activity are estimated at 541,488 MCF. Details are in section M.

Overall cost-effectiveness = $(\$110,608,776 - \$2,150,891) / 541,488 \text{ MCF} = \$200/\text{MCF}$

- b) Pneumatic Devices: Cost-effectiveness is evaluated for the replacement projects funded through SB 1371 and measures the estimated reductions in methane through year 2030 resulting from these projects.

Cost-effectiveness evaluations were generated by calculating the cumulative revenue requirement for activities that directly contribute to emissions reductions. The activity costs used to calculate the revenue requirement include the fully loaded and escalated capital investment and associated O&M, including on-going O&M over the useful life of the related capital asset, if applicable. The cumulative revenue requirement was divided by the total years of useful life to generate an average annual revenue requirement. Multiplying this annual average revenue requirement by 12 gives the estimated total cost of implementation for the SB 1371 program from 2018 through 2030.

Annual emissions reductions were compounded and summed to generate a total emissions reduction over the twelve-year program period.

Cost benefits were evaluated at the forecasted average annual WACOG published in the 2016 California Gas Report, converted to cost per MCF using a BTU conversion factor of 1.0343.

Cost-effectiveness is generated by dividing the cost of implementation less any cost benefits by estimated emission reduction.

Cost-Effectiveness for Replacement of Pneumatics

The average annual revenue requirement for this Best Practice is \$39,826. Over the twelve-year period, 2018-2030, the total revenue requirement is estimated at \$477,912.

Cost Benefits over the period from 2018-2030 are estimated at \$538,027. Details are in section K.

The compounded emissions reductions from 2018-2030 for this activity are estimated at 129,618 MCF. Details are in section M.

Overall cost-effectiveness = $(\$477,912 - \$538,027) / 129,618 \text{ MCF} = \$0/\text{MCF}$

- c) Meter replacement policy: Assumption is all residential meters currently going to PMC can be kept in service by using a billing calibration adjustment factor. Cost-effectiveness is measured by dividing the reduction in methane emissions by the cost of implementation, including the lifecycle of the capital assets less the cost of gas saved, evaluated at the weighted average cost of gas (WACOG) and less any cost benefits. Because the cost benefits exceed the up-front cost of this project, the cost-effectiveness is anticipated to be a negative number indicating that operational and maintenance savings will ultimately recover the initial costs of implementing this Best Practice.
- d) Differential Pressure Testing of Rotary Meters: Assumption is all rotary meters can use differential pressure testing for accuracy tests. Cost-effectiveness is measured by dividing the reduction in methane emissions by the cost of implementation, including the lifecycle of the capital assets less the cost of gas saved, evaluated at the weighted average cost of gas (WACOG) and less any cost benefits. Because the cost benefits are expected exceed the up-front cost of this project, the cost-effectiveness is anticipated to be a negative number indicating that operational and maintenance savings will ultimately recover the initial costs of implementing this Best Practice.
- e) Vapor Recovery Systems In lieu of Rod Packing Replacements: SoCalGas does not have sufficient data to estimate emissions reductions from this activity and recommends gathering information on emissions while sizing each station for the vapor recovery system.

k) Identify any cost benefits from this BP, when cost estimates are known:

- a) Blowdown reduction: The cost of gas saved by reducing emissions, is estimated at \$2,150,891 over 2018-2030. Cost benefits were evaluated at the forecasted average annual WACOG published in the 2016 California Gas Report, converted to cost per MCF using a BTU conversion factor of 1.0343.

Year	WACOG (\$/MCF)	Reduced Emissions	Cost Benefits
2019	\$2.664188	45,124	\$120,219
2020	\$2.649745	45,124	\$119,567
2021	\$2.986593	45,124	\$134,767
2022	\$3.475680	45,124	\$156,837
2023	\$3.743690	45,124	\$168,930
2024	\$3.952100	45,124	\$178,335
2025	\$4.224613	45,124	\$190,631
2026	\$4.525677	45,124	\$204,217
2027	\$4.624728	45,124	\$208,686
2028	\$4.734834	45,124	\$213,655
2029	\$4.944888	45,124	\$223,133
2030	\$5.139493	45,124	\$231,914

- b) Pneumatic Devices: The cost of gas saved by reducing emissions, estimated at \$538,027 over 2018-2030. Cost benefits were evaluated at the forecasted average annual WACOG published in the 2016 California Gas Report, converted to cost per MCF using a BTU conversion factor of 1.0343.

Year	WACOG (\$/MCF)	Reduced Emissions	Cost Benefits
2019	\$2.664188	3,010	\$8,019
2020	\$2.649745	7,030	\$18,628
2021	\$2.986593	9,135	\$27,283
2022	\$3.475680	11,259	\$39,133
2023	\$3.743690	12,398	\$46,414
2024	\$3.952100	12,398	\$48,998
2025	\$4.224613	12,398	\$52,377
2026	\$4.525677	12,398	\$56,109
2027	\$4.624728	12,398	\$57,337
2028	\$4.734834	12,398	\$58,702
2029	\$4.944888	12,398	\$61,307
2030	\$5.139493	12,398	\$63,719

- c) Meter replacement policy: SoCalGas anticipates substantial savings in O&M and capital costs resulting from this policy change due to reduced labor needed for meter replacements and reduced capital needed for replacement meters. Savings are to be determined based on timing of policy change. Cost benefits associated with methane emission reduction is estimated at \$5,053. Cost benefits were evaluated at the forecasted average annual WACOG published in the 2016 California Gas Report, converted to cost per MCF using a BTU conversion factor of 1.0343.

Year	WACOG (\$/MCF)	Reduced Emissions	Cost Benefits
2019	\$2.664188	106	\$282
2020	\$2.649745	106	\$281
2021	\$2.986593	106	\$317
2022	\$3.475680	106	\$368
2023	\$3.743690	106	\$397
2024	\$3.952100	106	\$419
2025	\$4.224613	106	\$448
2026	\$4.525677	106	\$480
2027	\$4.624728	106	\$490
2028	\$4.734834	106	\$502
2029	\$4.944888	106	\$524
2030	\$5.139493	106	\$545

- d) Differential Pressure Testing of Rotary Meters: SoCalGas anticipates a savings in O&M resulting from this policy change due to reduced labor needed for meter accuracy testing.

Savings are to be determined. Cost benefits associated with methane emission reduction is estimated at \$238. Cost benefits were evaluated at the forecasted average annual WACOG published in the 2016 California Gas Report, converted to cost per MCF using a BTU conversion factor of 1.0343.

Year	WACOG (\$/MCF)	Reduced Emission	Cost Benefits
2019	\$2.664188	5	\$13
2020	\$2.649745	5	\$13
2021	\$2.986593	5	\$15
2022	\$3.475680	5	\$17
2023	\$3.743690	5	\$19
2024	\$3.952100	5	\$20
2025	\$4.224613	5	\$21
2026	\$4.525677	5	\$23
2027	\$4.624728	5	\$23
2028	\$4.734834	5	\$24
2029	\$4.944888	5	\$25
2030	\$5.139493	5	\$26

- e) Vapor Recovery Systems in Lieu Rod Packing Replacements: There isn't sufficient data to quantify the cost benefits at this time.
- f) RD&D Projects: There isn't sufficient data to quantify the cost benefits at this time.

l) Do any incremental costs, if known, or benefits overlap with other BPs? If so, to which BP do they overlap, what are they, and how do they overlap?

N/A

m) Anticipated Emissions Reductions from this BP:

- a) Blowdown reduction: Assumptions for emissions reductions for blowdown include an average blowdown of 2,865 MCF per event, which was the average over years 2016-2017. It also assumed an average reduction of 70% when blowdown capture is performed. The compounded emissions reductions from 2018-2030 for this activity are estimated at 541,488 MCF.

Year	Year-of emissions reductions (MCF)	Compounded Emissions Reductions (MCF)
2019	45,124	45,124
2020	45,124	90,248
2021	45,124	135,372
2022	45,124	180,496
2023	45,124	225,620
2024	45,124	270,744
2025	45,124	315,868
2026	45,124	360,992
2027	45,124	406,116
2028	45,124	451,240
2029	45,124	496,364
2030	45,124	541,488

- b) Pneumatic Devices: Replacement of all high bleed pneumatics is expected to be completed in 2022. The compounded emissions reductions from 2018-2030 for this activity are estimated at 129,618 MCF.

Year	Year-of emissions reductions (MCF)	Compounded Emissions Reductions (MCF)
2019	3,010	3,010
2020	7,030	10,040
2021	9,135	19,175
2022	11,259	30,434
2023	12,398	42,832
2024	12,398	55,230
2025	12,398	67,628
2026	12,398	80,026
2027	12,398	92,424
2028	12,398	104,822
2029	12,398	117,220
2030	12,398	129,618

- c) Meter replacement policy: SoCalGas estimates that about 75,000 meters can be kept in service each year using a billing calibration adjustment factor, providing an estimated annual savings of 106 MCF. Over the twelve-year period from 2018-2030, the estimated emission reduction is 1,272 MCF.

Year	Year-of emissions reductions (MCF)	Compounded Emissions Reductions (MCF)
2019	106	106
2020	106	212
2021	106	318
2022	106	424
2023	106	530
2024	106	636
2025	106	742
2026	106	848
2027	106	954
2028	106	1,060
2029	106	1,166
2030	106	1,272

- d) Differential Pressure Testing of Rotary Meters: Assumption is all rotary meters can use differential pressure testing for accuracy tests. SoCalGas estimates that about 250,000 meters can be tested using DP annually, providing an estimated annual savings of 5 MCF. Over the twelve-year period from 2018-2030, the estimated emission reduction is 60 MCF.

Year	Year-of emissions reductions (MCF)	Compounded Emissions Reductions (MCF)
2019	5	5
2020	5	10
2021	5	15
2022	5	20
2023	5	25
2024	5	30
2025	5	35
2026	5	40
2027	5	45
2028	5	50
2029	5	55
2030	5	60

- e) Vapor Recovery Systems In Lieu of Rod Packing Replacements: SoCalGas does not have sufficient data to estimate emissions reductions from this activity and recommends gathering current emissions data, which will be needed for sizing vapor recovery units and to generate evaluations of emission reductions, cost benefits, and cost-effectiveness.

2015 Baseline Emissions affected, where known:

- a) Blowdown reduction: Assumptions for emissions reductions for blowdown include an average blowdown of 2,865 MCF per event of this type. The number of events varies by year so the opportunity for reduction will vary. The total 2016 baseline included 167 events for 144,486 MCF in emissions. Activities contributing to these emissions include abandonment or isolation of pipeline, hydrotests, pipe section replacement, tie-in projects, valve replacement or installation, equipment maintenance, pigging operation launcher or receiver, and transmission odor intensity tests. Calculation of the average blowdown per event was based on emissions from abandonment or isolation of pipeline, hydrotests, pipe section replacement, tie-in projects, and valve replacement or installation projects.
- b) Pneumatic Devices: The 2016 baseline for high-bleed pneumatic devices is 12,398 MCF
- c) Meter replacement policy: 2016 baseline emissions were 457 MCF.
- d) Differential Pressure Testing of Rotary Meters: 2016 baseline emissions were 5 MCF.
- e) Vapor Recovery Systems In Lieu of Rod Packing Replacements: SoCalGas does not have sufficient data to estimate emissions reductions from this activity and recommends gathering current emissions data, which will be needed for sizing vapor recovery units and to generate evaluations of emission reductions, cost benefits, and cost-effectiveness.

n) Calculation Methodology:

Assumptions and methodologies are described in section M

o) Additional Comments:

The proposed Meter Change Policy requires a timely decision to be impactful. A large quantity of meter replacements are scheduled to be completed in the next three years due to the projected large increase of replacements. A timely implementation of this change would reduce emissions from those replacements and provide substantial cost benefits to customers. This change would require a modification of General Order 58A.

p) Overlap with Safety:

N/A

SUPPLEMENTAL INFORMATION

a) Technology:

b) Changes to Operations:

c) Research or Studies:

d) Other:

The accompanying attachments have been redacted to remove non-responsive, non-relevant employee information.

Attachment P: Pipeline Blowdowns in Transmission and Distribution

Attachment Q: Resolution G-3257

Best Practice 24: Dig-Ins and Public Education Program

2018 LEAK ABATEMENT COMPLIANCE PLAN TEMPLATE (D.17-06-015)

PART 1: OVERVIEW

a) Best Practice: #24

b) Status: Work pending approval of AL 5211

Dig-Ins – Expand existing public education program to alert the public and third-party excavation contractors to the Call Before You Dig – 811 program. In addition, utilities must provide procedures for excavation contractors to follow when excavating to prevent damaging or rupturing a gas line.

PART 2: BEST PRACTICE DETAILS

a) Historic work:

SoCalGas has a federally-mandated Public Awareness program, as prescribed in 49 CFR 192.616, which contributes to enhanced public safety by providing risk mitigation measures. SoCalGas has a continuing awareness program to inform and educate its customers, affected public, appropriate public officials, and persons engaged in excavation-related activities on the prevention and recognition of gas pipeline emergencies. This program also includes the proper process for reporting an incident to SoCalGas and the appropriate public officials including first responders.

The program and the media used will be as comprehensive as necessary to reach all areas in the service territory in which the Company transports natural gas and where Company facilities exist (e.g., pipelines, storage fields, compressor stations).

Data shows the number of damages decrease while the number of calls to 811 (Underground Service Alert) increases. Data also suggest that the number of locate and mark activities is directly correlated with SoCalGas' investment in the Public Awareness Program. Therefore, SoCalGas requested money in the 2019 GRC to increase spending in these areas to further contribute to lowering the numbers of damage.

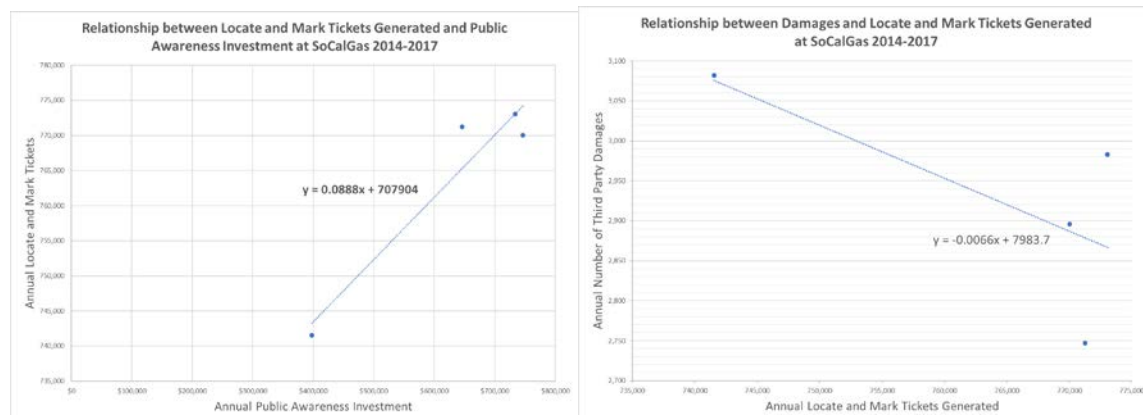

Expansions from the GRC funding is to conduct surveys to raise safety awareness and better address how to implement the program to promote safety. Additional funding to expand this program from an emissions perspective is proposed in this Best Practice, focusing efforts to minimize emissions. Trending the relationship between investment in the Public Awareness Program and Third-Party Damages for years 2014-2017 increase in public awareness campaigns should result in decreased damages, and therefore, lower emissions.

b) Alternative Proposal to BP or exemption? No

c) Proposed Plan:

To expand the existing public education program, SoCalGas proposes conducting incremental outreach and education to the general public, outreach to contractors and excavators, mailing safe digging procedures to contractors, and incremental FTEs for the public awareness program. The request for funding in the GRC for program expansion is targeted towards high consequence areas with the primary goal of safety. The SB 1371 funding for the public education program will allow us to expand the focus beyond high consequence areas with the goal of minimize emissions regardless of safety impact.

Additional funding to expand this program from an emissions perspective is proposed in this Best Practice, focusing efforts to minimize emissions. Trending the relationship between investment in the Public Awareness Program and Third-Party Damages for years 2014-2017 shows that an increase in public awareness campaigns should result in decreased damages, and therefore, lower emissions.

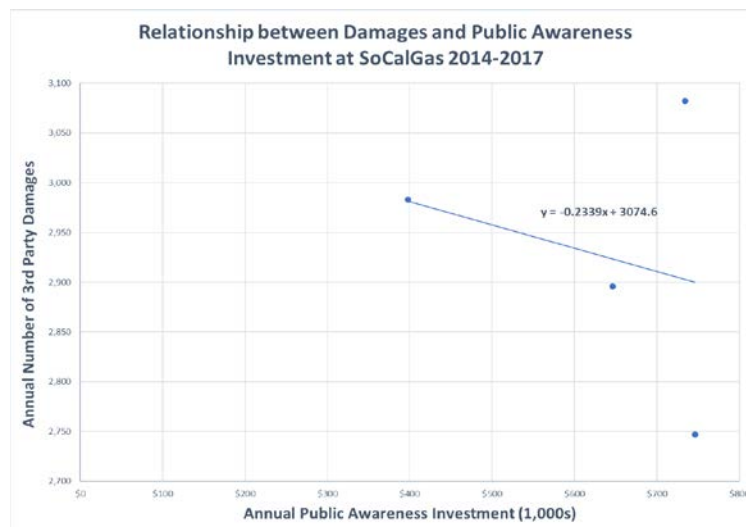

d) Overlap with other regulations? What portion of the BP is incremental beyond those regulations?

Other regulations regarding the Public Education Program include 49 C.F.R. § 192.616 and Public Awareness Programs for Pipeline Operators, API RP 1162. The requirements of these regulations are met and funded by the General Rate Case. The incremental funding requested in this program is to

expand the public awareness program beyond what is required for safety so damages are minimized as much as possible with the added goal of reducing emissions.

e) What technology is required to implement the best practice and why?

Several forms of media communication will be used to communicate with contractors, excavators, and the general public. Additional outreach and education to general public includes media TV PSA spots, endorsements on mainstream, sports radio, and digital ads.

f) Will work require additional personnel and/or contract support? If so, please provide details.

Two incremental FTEs are requested to manage additional activities associated with BPs, coordinating additional data gathering, mailings, outreach effectiveness, collaborating with Customer Communications for current messaging.

g) What changes to existing operations are required? How will those changes be implemented?

No operational changes are expected from the activities in this Best Practice.

h) What are the new procedures to develop or existing procedures to modify? Please provide details.

No procedural changes are expected from the activities in this Best Practice.

i) Timeline for implementation (Milestones):

All milestones are listed as the approximate length of time to completion from the date cost recovery is approved.

- Incremental employees hired and trained: 9 months
- Incremental communications, mailers, data gathering and messaging developed and implemented: 12 months

j) Identify the range of factors or considerations used to determine cost-effectiveness of this measure, when costs estimates have been determined:

Cost-effectiveness evaluations were generated by calculating the cumulative revenue requirement for activities that directly contribute to emissions reductions. The activity costs used to calculate the revenue requirement include the fully loaded and escalated capital investment and associated O&M, including on-going O&M over the useful life of the related capital asset, if applicable. The cumulative revenue requirement was divided by the total years of useful life to generate an average annual revenue requirement. Multiplying this annual average revenue requirement by 12 gives the estimated total cost of implementation for the SB 1371 program from 2018 through 2030.

Annual emissions reductions were compounded and summed to generate a total emissions reduction over the twelve-year program period.

Cost benefits were evaluated at the forecasted average annual WACOG published in the 2016 California Gas Report, converted to cost per MCF using a BTU conversion factor of 1.0343.

Cost-effectiveness is generated by dividing the cost of implementation less any cost benefits by estimated emission reduction.

Cost-Effectiveness for Expanded Public Awareness Program

The average annual revenue requirement for this Best Practice is \$1,386,072. Over the twelve-year period from 2018-2030, the total revenue requirement is estimated at \$16,632,864.

Cost Benefits over the period from 2018-2030 are estimated at \$258,494. Details are in section K.

The compounded emissions reductions from 2018-2030 for this activity are estimated at 65,076 MCF. Details are in section M.

Overall cost-effectiveness = $(\$16,632,684 - \$258,494) / 65,076 \text{ MCF} = \$252/\text{MCF}$

k) Identify any cost benefits from this BP, when cost estimates are known:

The cost of gas saved by reducing emissions is estimated at \$258,494 over 2019-2030. Cost benefits were evaluated at the forecasted average annual WACOG published in the 2016 California Gas Report, converted to cost per MCF using a BTU conversion factor of 1.0343.

Year	WACOG (\$/MCF)	Reduced Emissions	Cost Benefits
2019	\$2.664188	5,423	\$14,448
2020	\$2.649745	5,423	\$14,370
2021	\$2.986593	5,423	\$16,196
2022	\$3.475680	5,423	\$18,849
2023	\$3.743690	5,423	\$20,302
2024	\$3.952100	5,423	\$21,432
2025	\$4.224613	5,423	\$22,910
2026	\$4.525677	5,423	\$24,543
2027	\$4.624728	5,423	\$25,080
2028	\$4.734834	5,423	\$25,677
2029	\$4.944888	5,423	\$26,816
2030	\$5.139493	5,423	\$27,871

l) Do any incremental costs, if known, or benefits overlap with other BPs? If so, to which BP do they overlap, what are they, and how do they overlap?

The IT system proposed in Best Practice 26 can be used in conjunction with these efforts to track the effectiveness of certain outreach efforts and identify a relationship between communications with specific contractors, excavators, and the general public and the amount of emissions released as a result of damages. The more information available regarding damage prevention, the better equipped SoCalGas will be to proactively prevent line damages.

m) Anticipated Emissions Reductions from this BP:

SoCalGas trended the relationship between investment in the Public Awareness Program and Third-Party Damages for years 2014-2017, which shows that investment in public awareness is negatively correlated with the number of third party damages to company property. Therefore, an increase in public awareness campaigns should result in decreased damages, and therefore, lower emissions. The regression between investment in public awareness is $y = -0.2339x + 3074.6$. The average public awareness investment for years 2014-2017 was \$631,076 per year. Using that as a baseline for investment, increasing by the proposed \$963,360 request would put the annual investment at \$1,594,436. Plugging that into the regression model gives us an estimated 2701 damages. With an average of 20 MCF per damage (based on emissions data from 2015 and 2016), estimated annual methane emissions is 54,020 MCF. The emission baseline from 2015 was 59,443 MCF, so this is an estimated reduction of 5,423 MCF per year.

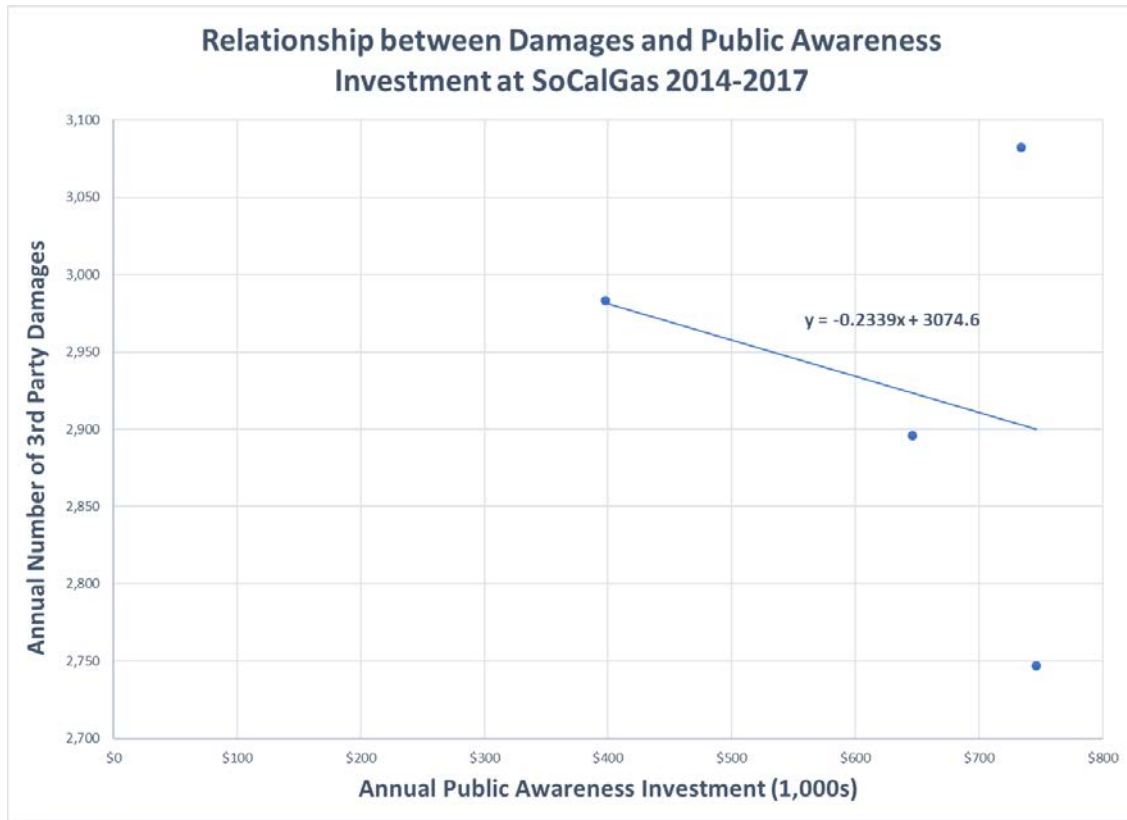

Items	Proposed	2017	2016	2015	2014
Total Public Awareness Spend (000s)	\$1,594	\$746	\$398	\$734	\$646
Total number of damages	2,701	2,896	3,082	2,983	2,747

Year	Year-of emissions reductions (MCF)	Compounded Emissions Reductions (MCF)
2019	5,423	5,423
2020	5,423	10,846
2021	5,423	16,269
2022	5,423	21,692
2023	5,423	27,115
2024	5,423	32,538
2025	5,423	37,961
2026	5,423	43,384
2027	5,423	48,807
2028	5,423	54,230
2029	5,423	59,653
2030	5,423	65,076

2015 Baseline Emissions affected, where known:

The emission baseline from 2015 was 59,443 MCF.

n) Calculation Methodology:

SoCalGas trended the relationship between investment in the Public Awareness Program and Third-Party Damages for years 2014-2017, which shows that investment in public awareness is negatively correlated with the number of third party damages to company property. Therefore, an increase in public awareness campaigns should result in decreased damages, and therefore, lower emissions. The regression between investment in public awareness is $y = -.2339x + 3074.6$. The average public awareness investment for years 2014-2017 was \$631,076 per year. Using that as a baseline for investment, increasing by the proposed \$963,360 request would put the annual investment at \$1,594,436. Plugging that into the regression model gives us an estimated 2701 damages. With an average of 20 MCF per damage (based on emissions data from 2015 and 2016), estimated annual methane emissions is 54,020 MCF. The emission baseline from 2015 was 59,443 MCF, so this is an estimated reduction of 5,423 MCF per year.

o) Additional Comments:

N/A

p) Overlap with Safety:

Safety regulations regarding the Public Education Program include 49 C.F.R. § 192.616 and Public Awareness Programs for Pipeline Operators, API RP 1162. The requirements of these regulations are met and funded by the General Rate Case. The incremental funding requested in this program is to expand the public awareness program beyond what is required for safety so damages are minimized as much as possible with the added goal of reducing emissions.

SUPPLEMENTAL INFORMATION

a) Technology:
b) Changes to Operations:
c) Research or Studies:
d) Other: The accompanying attachments have been redacted to remove non-responsive, non-relevant employee information. Attachment R: Public Awareness Plan for SoCalGas and SDG&E

Best Practice 25: Dig-Ins and Company Standby Monitors

2018 LEAK ABATEMENT COMPLIANCE PLAN TEMPLATE (D.17-06-015)

PART 1: OVERVIEW	
a) Best Practice: #25	b) Status: Work pending approval of AL 5211
<p>Dig-Ins – Utilities must provide company monitors to witness all excavations near gas transmission lines to ensure that contractors are following utility procedures to properly excavate and backfill around transmission lines.</p>	
PART 2: BEST PRACTICE DETAILS	
a) Historic work:	
<p>The State of California mandates a preconstruction meeting with excavators requesting Locate and Mark support and requires continuous monitoring of all excavations within ten feet of high priority subsurface installation per Cal. Gov't Code § 4216.2. SoCalGas has historically interpreted high priority subsurface installation to mean high pressure pipeline.</p> <p>SoCalGas has a federally-mandated Public Awareness program, as prescribed in 49 CFR 192.616, which contributes to enhanced public safety by providing risk mitigation measures. When excavators generate a ticket through Underground Service Alert, locate and mark employees identify gas lines in the delineated area and if a high-pressure line is identified, the excavator is contacted and instructed that a SoCalGas employee must be on-site during all excavation activities in the vicinity of the pipeline. When the excavator confirms the timing of the excavation activity an observer is assigned to monitor the excavation.</p>	
b) Alternative Proposal to BP or exemption? No	
c) Proposed Plan:	
<p>SoCalGas already meets the minimum requirements for this Best Practice, but SoCalGas sees an opportunity to expand the program to have excavation monitors over projects where there could be challenges to controlling a damage, causing higher levels of emissions. For example, pressure districts with a single feed may cause challenges to performing damage repairs without dropping service to customers. In a situation like this, repairs may be delayed while a bypass is built or supplemental alternative fuel is sourced. Providing standby monitors to observe excavation operations has been shown to significantly reduce the risk of damage, so it would be beneficial to expand this program to reduce emissions.</p>	

d) Overlap with other regulations? What portion of the BP is incremental beyond those regulations?

The State of California mandates a preconstruction meeting with excavators requesting Locate and Mark support and requires continuous monitoring of all excavations within ten feet of high-pressure pipelines per Cal. Gov't Code § 4216.2. Other regulations regarding the Public Education Program include 49 C.F.R. § 192.616 and Public Awareness Programs for Pipeline Operators, API RP 1162. The requirements of these regulations are met and funded by the General Rate Case. The incremental funding requested in this program is to expand the monitoring program beyond what is required for safety so damages are minimized as much as possible with the added goal of reducing emissions.

e) What technology is required to implement the best practice and why?

The IT system proposed in Best Practice 26 can be used in conjunction with these efforts to track the effectiveness of certain outreach efforts and identify a relationship between communications with specific contractors, excavators, and the general public and the amount of emissions released as a result of damages. The more information available regarding damage prevention, the better equipped SoCalGas will be to proactively prevent line damages.

f) Will work require additional personnel and/or contract support? If so, please provide details.

One incremental FTE is requested to provide standby observation for increased excavation activities, resulting from expanding the standby program. Increased standby activities are also expected due to increase in locate and mark activities resulting from the expanded Public Awareness Program proposed in Best Practice 24 and the USA ticket prioritization application proposed in the GRC.

g) What changes to existing operations are required? How will those changes be implemented?

While monitoring incremental projects is an increase in work, it does not change the way the work is performed so no changes to operations are required.

h) What are the new procedures to develop or existing procedures to modify? Please provide details.

Gas Standard 184.09 will need to be updated to reflect incremental requirements for locate and mark activities that will require a standby monitor. High priority areas requiring standby will need to be redefined.

i) Timeline for implementation (Milestones):

All milestones are listed as the approximate length of time to completion from the date cost recovery is approved.

- Policy updates completed and reviewed: 9 months
- Incremental employees hired and trained: 9 months
- Field trained on updated policies: 9 months

<ul style="list-style-type: none"> • Policy changes published and full field implementation: 12 months
<p>j) Identify the range of factors or considerations used to determine cost-effectiveness of this measure, when costs estimates have been determined:</p> <p>There isn't sufficient historical data to estimate emission reductions as a result of expanding the standby locate and mark activities.</p>
<p>k) Identify any cost benefits from this BP, when cost estimates are known:</p> <p>There isn't sufficient historical data to estimate emission cost benefits resulting from expanding the standby locate and mark activities.</p>
<p>l) Do any incremental costs, if known, or benefits overlap with other BPs? If so, to which BP do they overlap, what are they, and how do they overlap?</p> <p>The IT system proposed in Best Practice 26 can be used in conjunction with these efforts to track the effectiveness of the expanded standby program, certain outreach efforts and identify a relationship between communications with specific contractors, excavators, and the general public and the amount of emissions released as a result of damages. The more information available regarding damage prevention, the better equipped SoCalGas will be to proactively prevent line damages.</p>
<p>m) Anticipated Emissions Reductions from this BP:</p> <p>There isn't sufficient historical data to estimate emission reductions as a result of expanding the standby locate and mark activities.</p> <p>2015 Baseline Emissions affected, where known:</p> <p>N/A</p>
<p>n) Calculation Methodology:</p> <p>N/A</p>
<p>o) Additional Comments:</p> <p>N/A</p>
<p>p) Overlap with Safety:</p> <p>The State of California mandates a preconstruction meeting with excavators requesting Locate and Mark support and requires continuous monitoring of all excavations within ten feet of high-pressure pipelines per Cal. Gov't Code § 4216.2. Safety regulations regarding the Public Education Program include 49 C.F.R. § 192.616 and Public Awareness Programs for Pipeline Operators, API RP 1162. The requirements of these regulations are met and funded by the General Rate Case. The incremental funding requested in this program is to expand the public awareness program beyond</p>

what is required for safety so damages are minimized as much as possible with the added goal of reducing emissions.

SUPPLEMENTAL INFORMATION

a) Technology:

b) Changes to Operations:

c) Research or Studies:

d) Other:

The accompanying attachments have been redacted to remove non-responsive, non-relevant employee information.

Attachment S: Gas Standard 184.09

Best Practice 26: Dig-Ins and Repeat Offenders

2018 LEAK ABATEMENT COMPLIANCE PLAN TEMPLATE (D.17-06-015)

PART 1: OVERVIEW

a) Best Practice: #26

b) Status: Work pending approval of AL 5211

Utilities shall document procedures to address Repeat Offenders such as providing post-damage safe excavation training and on-site spot visits. Utilities shall keep track and report multiple incidents, within a 5-year period, of dig-ins from the same party in their Annual Emissions Inventory Reports. These incidents and leaks shall be recorded as required in the recordkeeping best practice. In addition, the utility should report egregious offenders to appropriate enforcement agencies including the California Contractor's State License Board. The Board has the authority to investigate and punish dishonest or negligent contractors. Punishment can include suspension of their contractor's license.

PART 2: BEST PRACTICE DETAILS

a) Historic work:

SoCalGas has a federally-mandated Public Awareness program, as prescribed in 49 CFR 192.616, and Damage Prevention Program CFR192.614 which contribute to enhanced public safety by providing risk mitigation measures. When excavators generate a ticket through Underground Service Alert, locate and mark employees identify lines in the area and if a high pressure line is identified, an observer is assigned to monitor the excavation. Data shows that the more Underground Service Alert is used, the less damages occur.

Damage information is entered by hand into a form by the employee(s) dispatched to repair the damaged property. The information from this form is then manually transferred into the Company Property Damage Report System. SoCalGas operates three separate data systems that store line damage information: 1) Incident Management System; 2) SAP; and 3) the Company Property Damage Report System. These systems currently do not have any synergy, which can generate challenges when reporting and requires employees to enter the same information three different times and three different ways.

SoCalGas currently uses the Company Property Damage Report System to track repeat offenders, and any offender with more than two damages in the previous quarter will be added to a list that is provided on a quarterly basis to the CPUC. However, this list is over simplified because repeat offenders may have a multi-year history of damaging facilities, not only on SoCalGas lines but on other utilities. An excavator may be damaging every utility in California once a quarter and based on this reporting standard, they would never be labeled as a "repeat offender".

b) Alternative Proposal to BP or exemption? No**c) Proposed Plan:**

SoCalGas is proposing to implement an IT project that will centralize data from damage claims and locate and mark activities, generating a report of repeat offenders. This project will provide synergy capabilities between the Incident Management System, SAP, and the Company Property Damage Report System. SoCalGas proposes one incremental FTE that will oversee this activity and be responsible for coordinating trainings, communications, and reporting required. Enhanced IT capabilities would increase mobility on how SoCalGas captures damages to better perform analytics, to put in place preventative measures to mitigate damages. System integration would improve data analytic capabilities, reduce labor, and enhance the success of the Public Awareness and Damage Prevention Programs goals of reducing methane emissions. This system would also be able to look at the damage history holistically and identify repeat offenders more readily.

d) Overlap with other regulations? What portion of the BP is incremental beyond those regulations?

The State of California mandates a preconstruction meeting with excavators requesting Locate and Mark support Cal. Gov't Code § 4216.2 and the Company requires continuous monitoring of all excavations within ten feet of high-pressure pipelines. Other regulations regarding the Damage Prevention Program CFR 192.614, Public Education Program include 49 C.F.R. § 192.61f and Public Awareness Programs for Pipeline Operators, API RP 1162. The requirements of these regulations are met and funded by the General Rate Case. The incremental funding requested in this program is to expand upon what is required for the damage prevention program to identify excavators that repeatedly damage lines, causing increased emissions, and implement consequences for doing so.

e) What technology is required to implement the best practice and why?

The IT system proposed in this Best Practice will be used to identify, track, and document repeat offender contractors, report repeat offenders to Contractors State Licensing Board, and work with new California Underground Facilities Safety Protection Board to go after repeat offenders. It will also be used in conjunction with Best Practices 24 and 25, as well as Best Practice 9 to track the effectiveness of certain outreach efforts and identify a relationship between communications with specific contractors, excavators, and the general public and the amount of emissions released as a result of damages. The more information available regarding damage prevention, the better equipped SoCalGas will be to proactively prevent line damages.

This project will provide synergy capabilities between the Incident Management System, SAP, and the Company Property Damage Report System. Enhanced IT capabilities would increase mobility on how SoCalGas captures damages to better perform analytics, to put in place preventative measures to mitigate damages. System integration would improve data analytic capabilities, reduce labor, and enhance the success of the Public Awareness and Damage Prevention Programs goals of reducing

methane emissions. This system would also be able to look at the damage history holistically and identify repeat offenders more readily.

f) Will work require additional personnel and/or contract support? If so, please provide details.

One incremental FTE is requested to identify, track, and document repeat offender contractors, report repeat offenders to Contractors State Licensing Board, and work with new California Underground Facilities Safety Protection Board to go after repeat offenders.

g) What changes to existing operations are required? How will those changes be implemented?

This Best Practice introduces new responsibilities to identify, track, and document repeat offender contractors, report repeat offenders to Contractors State Licensing Board, and work with new California Underground Facilities Safety Protection Board to go after repeat offenders.

h) What are the new procedures to develop or existing procedures to modify? Please provide details.

New procedures will need to be developed to reflect incremental requirements to identify, track, and document repeat offender contractors, report repeat offenders to Contractors State Licensing Board, and work with new California Underground Facilities Safety Protection Board to go after repeat offenders.

i) Timeline for implementation (Milestones):

All milestones are listed as the approximate length of time to completion from the date cost recovery is approved.

- Incremental employees hired and trained: 9 months
- Commission IT project and generate scope of work: 6 months
- Field trained on updated policies: 9 months
- Policy changes published and full field implementation: 12 months
- IT project completed and fully implemented: 24 months

j) Identify the range of factors or considerations used to determine cost-effectiveness of this measure, when costs estimates have been determined:

There is insufficient data to calculate emissions reductions expected from the activities in this Best Practice.

k) Identify any cost benefits from this BP, when cost estimates are known:

Implementation of this IT project may result in less labor needs for manual data entry. SoCalGas is not able to quantify this benefit until the scope of work is generated.

l) Do any incremental costs, if known, or benefits overlap with other BPs? If so, to which BP do they overlap, what are they, and how do they overlap?

The IT system proposed in this Best Practice will be used to identify, track, and document repeat offender contractors, report repeat offenders to Contractors State Licensing Board, and work with new California Underground Facilities Safety Protection Board to go after repeat offenders. It will also be used in conjunction with Best Practices 24 and 25, as well as Best Practice 9 to track the effectiveness of certain outreach efforts and identify a relationship between communications with specific contractors, excavators, and the public and the amount of emissions released as a result of damages. The more information available regarding damage prevention, the better equipped SoCalGas will be to proactively prevent line damages.

m) Anticipated Emissions Reductions from this BP:

There is insufficient data to estimate emission reductions from the activities in this Best Practice. However, SoCalGas does believe there will be some emission reductions because excavators will become motivated to using locate and mark services to evade negative consequences associated with reporting repeat offenders.

2015 Baseline Emissions affected, where known:

N/A

n) Calculation Methodology:

N/A

o) Additional Comments:

N/A

p) Overlap with Safety:

The State of California mandates a preconstruction meeting with excavators requesting Locate and Mark support of high-pressure pipelines per Cal. Gov't Code § 4216.2 and the Company requires continuous monitoring of all excavations within ten feet of a high pressure facility. Safety regulations regarding the Damage Prevention Program CFR192.614, Public Education Program include 49 C.F.R. § 192.61f and Public Awareness Programs for Pipeline Operators, API RP 1162. The requirements of these regulations are met and funded by the General Rate Case. The incremental funding requested in this program is to expand the public awareness program beyond what is required for safety so damages are minimized as much as possible with the added goal of reducing emissions.

SUPPLEMENTAL INFORMATION

a) Technology:

b) Changes to Operations:
c) Research or Studies:
d) Other:



Environmental Excellence Policy

Responsible Dept.: Environmental Services
 Responsible Officer: VP of Operations Support
 and Chief Environmental Officer
Applicability: SoCalGas Employees

EFFECTIVE DATE: 05/14/2012
 REVIEW DATE: 07/01/2016

INFORMATION TYPE: **Public**
 Questions?

Contact: [SCG Business Controls Group](#)

POLICY:

Environmental excellence means being a responsible steward of the earth's cultural and natural resources and conserving plant and animal species along with their habitats. SoCalGas is a responsible steward and conducts its activities in a way that protects the current and long-term wellbeing of our employees, the public, and the environment to meet the needs of the present without impacting the ability of future generations to meet their needs.

Energy Efficiency & Air Quality /Climate Change

Energy efficiency is a fundamental element in the progress toward a sustainable energy future. SoCalGas is determined to assist our customers in consuming less energy. SoCalGas will continue to focus on delivering a reliable natural gas supply and services that are competitively priced and supports a low-carbon model that includes natural gas, biogas, energy efficiency, clean transportation, distributed generation and innovative technologies that reduce the emission of criteria pollutants and greenhouse gases that contribute to climate change. **SoCalGas recognizes that methane is a potent Green House Gas that must be prevented from escaping to the atmosphere and supports the activities prescribed in Senate Bills 1371 and 1383 to reduce methane emissions.**

Natural and Cultural Diversity

California is among the top ten biodiversity regions on earth and as a result is rich in natural and cultural resources. SoCalGas recognizes the overall challenge of environmental sustainability is the protection of these resources. SoCalGas is committed to conducting its operations in a way that promotes the preservation of these resources through coordinated and comprehensive programs of avoidance, minimization and /or mitigation of impacts. SoCalGas is further committed to reducing water consumption and preserving water quality through the design and operation of our facilities.

Lifecycle of Operations and Other Business Activities

SoCalGas is committed to preventing pollution throughout the life cycle of our operations and business activities by improving our environmental management systems. This includes minimizing energy and fuel usage, "greening" procurement practices, maintaining control over the chemical substances and materials used, reducing, substituting, and eliminating substances that have potentially significant impacts, and maximizing the recycling of wastes and byproducts.

INFORMATION RETENTION GUIDANCE

For guidance as to the appropriate retention period for records related to this policy, please refer to the Standard Records Series in the [Records & Information Management](#) intranet site and the [Information Management Policy](#).

You may raise questions or concerns about compliance or ethics issues by visiting our anonymous Sempra Energy Ethics & Compliance Helpline website at www.SempraEthics.com or by calling one of the Ethics & Compliance Helplines below:

United States – 800-241-5689
 Mexico – 001-770-582-5249

Chile: 600-320-1700
 Peru: 0800-7-0690



Environmental Policy

Purpose

To succeed and grow as a company, we must balance economic and environmental concerns with the need to deliver energy that is safe and reliable, yet also clean and affordable. That is why we are committed to operating our companies in a way that is sustainable and respectful of the environment – from energy, water and waste, to land use and biodiversity management. This commitment goes beyond our immediate impact and includes our approach: what we focus on and how we work to promote energy efficiency, renewable energy, natural gas and innovation.

Our environmental policy:

- Underscores our commitment to abide by applicable environmental laws, regulations and permit requirements as we build and operate energy infrastructure;
- Challenges our businesses and employees to operate our assets, buildings and facilities with efficiency in mind – from energy and water use to waste and recycling;
- Articulates our aspirations to help our customers save energy and money by promoting efficiency and sustainability and pursuing innovative approaches that will benefit the environment and communities where we operate; and,
- Underscores our employees' and suppliers' roles in protecting the environment, as outlined in our Code of Business Conduct.

Policy Statement

The Sempra Energy companies will work internally to:

- Abide by applicable environmental laws, regulations and permit requirements as we build and operate energy infrastructure and produce, deliver and use energy;
- Implement environmental practices where possible and economically prudent, including water reuse and conservation, recycling and waste minimization, greenhouse gas and other air emissions reductions, air quality improvements, and the adoption of building and facility standards;



- Encourage innovation and enhanced cost effectiveness in methods of compliance, using practical means to gauge our performance, and implement appropriate environmental education and training programs for employees; and
- Review results, existing operations and management practices to allow for continuous improvement.

The Sempra Energy companies will work externally to:

- Support public policies and reasonable regulations that promote energy efficiency, renewable energy, and emission performance standards that encourage the use of clean fuels such as natural gas and that reduce environmental impacts using science, cost-effective technology, and common sense as the basis for these policies;
- Support reasonable regulations that govern the production of natural gas that benefits consumers, reduces environmental impact, and facilitates our nation's access to abundant supplies of natural gas;
- Implement appropriate environmental education and training programs for customers and other stakeholders;
- Work with business partners (including suppliers, vendors, and contractors) when possible to minimize impacts on the environment;
- Encourage the development and use of efficient, clean, and cost-effective technologies while helping our customers meet their energy needs in an environmentally responsible way;
- Share our goals, progress, and performance with stakeholders with transparency; and
- Promote sound and responsible stewardship of our environment in coordination with our customers, civic and community leaders.



SUSTAINABLE GROWTH

2016 CORPORATE RESPONSIBILITY REPORT



Contents

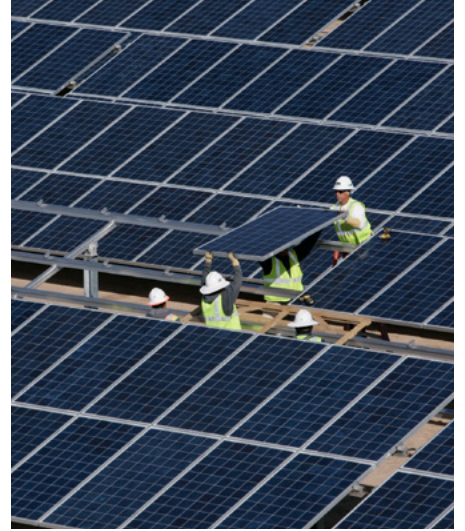
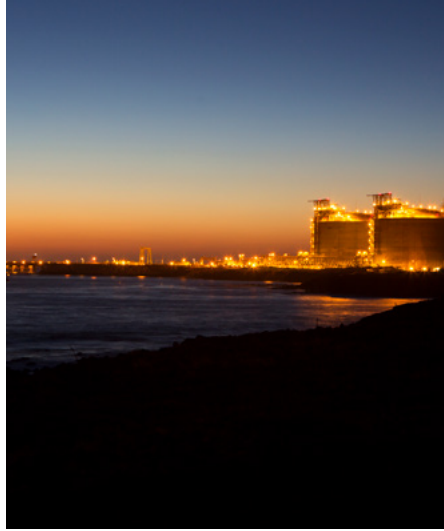

**Letter from our chairman,
president and CEO** **3**

Our business **4**

Year in review 4
Strategy and assets 9
Governance 12
Risk management 18

The environment **22**

Climate change 22
Emissions 30
Water 38
Waste and recycling 40
Environmental compliance 42
Biodiversity 43
Supply chain impacts 44



Our stakeholders 46

Employees	46
Customers and communities	54
Business partners and suppliers	60
Regulators	61
Investors and shareholders	61

About this report 62

Report overview	62
Performance data	64
Goals & results	65
Disclaimers	68
GRI index	71
Content index	85

Please consider the environment before printing. This document is accurate as of June 15, 2017. See sempira.com for the most up-to-date version.



The 470-megawatt Flat Ridge 2 wind farm near Wichita, Kan. , as shown on the cover.

Letter from our chairman, president and CEO

The roots of our company date back well over a century. Over time, we have grown and flourished by delivering safe, reliable and affordable energy to our customers.

While this is our core mission, we must do more. We must look to secure not only the sufficient energy resources, but also the public support, market demand and skilled employees we need.

This approach benefits both our business and our stakeholders.

- We minimize our environmental footprint. Our power generation emissions rate is roughly half the U.S. national average.
- We operate efficiently. In 2016, fresh water represented just 1 percent of our total water withdrawal.
- We evaluate potential projects based on a rigorous assessment of market trends. Most of our infrastructure assets are under contract for 20 years or longer.
- We respect our employees and their ideas. This report contains numerous examples of employee-driven innovation.
- We strive to improve our performance in a wide range of areas including safety, reliability, diversity, energy efficiency and customer satisfaction. As a result, independent third parties continue to rank our company high on their indexes and scorecards.

By the year 2050, experts believe that there will be nearly 10 billion people living on our planet. They will need water to drink, food to eat, clean air to breathe, jobs to support their families - and energy to power their lives. We are building a company today that will help meet the energy needs of future generations.

This is what we mean by "sustainable growth."

I welcome your comments and ideas as we continue our journey.



Debra L. Reed
Chairman, President and CEO

Note: Our chairman, president and CEO's "[Letter to Shareholders](#)" in our 2016 Annual Report and the video "[Balanced Growth](#)" provide additional detail on our vision and strategic priorities.



"We are building a company today that will help meet the energy needs of future generations."

Our business



The Energía Costa Azul LNG terminal in Baja California, Mexico.

Year in review 4

Strategy and assets 9

- Sempra Utilities
- Sempra Infrastructure

Governance 12

- Board of directors
- Shareholder engagement
- Values and code of conduct
- Political involvement

Risk management 18

- Key risks
- Risk management process
- Compliance and management systems
- Supplier selection and monitoring

Year in review

In 2016, Sempra Energy® met key financial and operational targets while recording earnings of \$1.37 billion on revenues of \$10.2 billion.

In January, after more than a year and a half of construction activities, the Cameron LNG liquefaction project team erected structural steel for the first of three liquefaction trains. This massive construction project - the largest in our history - has an expected in-service date of mid-2018 for the first train and mid-2019 for all three trains.

The California Public Utilities Commission (CPUC) voted to maintain the state's existing net energy metering program, a billing mechanism that credits owners of solar-power systems for the electricity they produce for the regional grid. San Diego Gas & Electric (SDG&E®) expressed concern with the program, which shifts the cost of maintaining the electrical grid to non-solar-owning customers, many of whom have lower incomes.

The CPUC approved SDG&E's pilot project to install 3,500 electric vehicle charging stations at 350 locations in its service territory.

In February, state regulators confirmed that the well that had been leaking at the Southern California Gas Company (SoCalGas®) Aliso Canyon natural gas storage facility had been permanently sealed and taken out of service.

Sempra LNG & Midstream signed a project development agreement with Woodside Petroleum Ltd. to explore joint development of the proposed Port Arthur LNG natural gas liquefaction facility, to include two natural gas liquefaction trains with a total export capability of 698 billion cubic feet per year.

In March, SDG&E and other California investor-owned utilities asked that the CPUC revisit its decision on net energy metering. The CPUC agreed to do so in 2019.

SDG&E announced that it signed a contract for a new 20-megawatt energy storage facility. The utility also contracted for 18.5 megawatts of energy-efficiency projects.

Forbes magazine named Sempra Energy one of America's best large employers for 2016.

In April, SoCalGas announced a plan to resume the injection of natural gas at its Aliso Canyon natural gas storage facility.

SoCalGas opened a new compressed natural gas (CNG) vehicle-fueling station in Murrieta, Calif. The station is open 24 hours a day and is located near the intersection of two interstate highways, I-15 and I-215, convenient for trucks and other commercial vehicles.

SDG&E announced that its renewable meter adapter had saved private solar customers millions of dollars since being introduced in August 2015. (Please see sidebar on [page 6](#) for more details.)

Sempra Energy Chairman, President and CEO Debra Reed launched an initiative to identify and explore opportunities to improve business processes, achieve efficiencies and support future growth. Hundreds of employees contributed their ideas.

Sempra Energy was named one of the 100 most trustworthy companies in America by *Forbes* magazine.

In May, Sempra LNG & Midstream completed the sale of its 25-percent interest in the Rockies Express natural gas pipeline.

SDG&E announced it would be investing \$7.5 million over the next five years in an educational campaign to inspire drivers to switch to electric vehicles. The campaign complements SDG&E's work to install 3,500 new electric vehicle charging stations at 350 locations in its service territory.



Cameron LNG construction, by the numbers¹

- Approximately 7,000 employees, contractors and temporary construction workers
- 21 million work hours to date
- 92 cranes spread over an area equivalent to 380 American football fields

¹as of April 2017



A SoCalGas compressed natural gas (CNG) vehicle-fueling station.



Employee-driven invention eases customer path to rooftop solar

The renewable meter adapter is a technology, pioneered by SDG&E, that makes installation of solar panels faster, safer and less expensive for customers.

Before a solar system can be installed, a typical customer's electric panel must be upgraded. This can be intricate, costly and time-intensive.

SDG&E's Ken Parks and Michael Colburn recognized that if customers could avoid the panel-upgrade work, adding solar would become easier.

Parks and Colburn and their team developed this concept and, in 2013, SDG&E filed a patent for the renewable meter adapter.

As of the end of 2016, the adapter had been installed in the homes of nearly 5,000 SDG&E customers, saving customers \$5 million in panel upgrade costs. In all, SDG&E has connected more than 100,000 private rooftop solar systems to its electric grid.

In June, our Mexico business IEnova was awarded a contract in partnership with TransCanada Corporation to build, own and operate an approximately 497-mile (800 kilometer), \$2.1 billion natural gas pipeline in Mexico. The 42-inch diameter South Texas-Tuxpan pipeline will have a capacity of 2.6 billion cubic feet per day, supplying natural gas, instead of fuel oil, to new and existing power plants.

In July, SoCalGas opened a new compressed natural gas (CNG) vehicle fueling station in Pico Rivera, Calif., adding to the utility's network of CNG stations.

The Cameron LNG liquefaction expansion project received authorization from the U.S. Department of Energy to expand the amount of LNG it may export to countries that do not have a free-trade agreement with the U.S. If the expansion project moves forward, it could add another two liquefaction trains to the Cameron LNG facility.

Sempra Renewables acquired the 100-megawatt Apple Blossom wind project in Michigan from Geronimo Energy LLC. When the facility is completed, Sempra Renewables, together with its partners, will have wind and solar facilities in 11 states, capable of generating nearly 2,400 megawatts of electricity.

In August, SDG&E received CPUC approval to build two energy storage projects with a combined capacity of 37.5 megawatts in San Diego County. Both projects have since been completed. Storage resources improve the reliability of the electric grid: batteries charge when there is an abundance of solar or wind power and can provide energy in the early evening when demand peaks.

In September, IEnova entered into an agreement to purchase the Ventika I and Ventika II wind-generation facilities in Nuevo León, Mexico. The project is the largest operating wind farm in Mexico, with 84 turbines and a combined electricity generation capacity of 252 megawatts. The acquisition was completed in December.

IEnova was awarded the rights to build two solar energy projects: The 41-megawatt La Rumorosa Solar complex in Baja California and the 100-megawatt Tepezalá II Solar complex in Aguascalientes, Mexico. As of June 15, 2017, both projects were in the final permitting stages.

IEnova acquired Petróleos Mexicanos' (PEMEX's) 50-percent equity interest in the Gasoductos de Chihuahua joint venture, increasing IEnova's ownership interest to 100 percent. Assets involved in the acquisition included three natural gas pipelines, an ethane pipeline, and a liquid petroleum gas pipeline and associated storage terminal.

SoCalGas announced the successful test of a system that captures natural gas associated with pipeline testing or replacement. The system, now in use, allows the utility to save the gas for later use instead of venting it to the atmosphere. Approximately 108,000 cubic feet of natural gas was captured in the test - equivalent to the amount used in approximately 500 U.S. homes each day.

Sempra Energy was named to the Dow Jones Sustainability North America Index, which recognizes North American companies that are in the top 20 percent in terms of economic, environmental and social performance.



SDG&E's Environmental All-Stars are employees who volunteer in their communities.

Sempra Energy also received an "A-" from CDP, formerly the Carbon Disclosure Project, for strong climate disclosure and performance.

Sempra LNG & Midstream sold EnergySouth, the parent company of natural gas utilities Mobile Gas and Willmut Gas, to Spire Inc., formerly known as The Laclede Group Inc.

In October, Sempra Renewables dedicated Mesquite Solar 3, a 150-megawatt solar facility in Tonopah, Arizona. The facility provides power to 14 Navy and Marine Corps installations in California.

SoCalGas began work on a \$3.4 million valve replacement and upgrade project at a natural-gas-valve station near Palmdale, Calif. The work is part of the utility's Pipeline Safety Enhancement Plan (PSEP), a multi-billion-dollar program that is testing and updating the region's natural gas pipeline infrastructure.

In November, Sempra LNG & Midstream filed applications with the Federal Energy Regulatory Commission (FERC) seeking authorization to site, construct and operate the Port Arthur LNG natural gas liquefaction facility in Southeast Texas. The proposed project would include two natural gas liquefaction trains capable of producing approximately 698 billion cubic feet of natural gas per year; three LNG storage tanks; and associated storage and marine facilities.

SoCalGas requested regulatory approval to resume limited injection operations and replenish the natural gas supply at its Aliso Canyon natural gas storage facility.

SoCalGas announced that it had successfully completed demonstration testing of new natural gas detection sensors, as part of its overall pipeline safety efforts. The sensors, now being installed in some locations, read concentration levels every five minutes and allow SoCalGas to remotely measure and monitor natural gas levels near high-pressure pipelines.

Sempra South American Utilities terminated negotiations to participate in the approximately \$6.5 billion Gasoducto Sur Peruano (GSP) natural gas pipeline project, citing concerns related to project risk.

In December, the CPUC approved SDG&E's proposal to construct the South Orange County Reliability Enhancement project which will improve electric reliability by adding a second power source for 300,000 residents in southern Orange County.

At year-end, half of the generating capacity across all Sempra Energy businesses came from solar, wind and hydroelectric power plants.



SDG&E announced that it signed a memorandum of understanding with XL Hybrids to purchase up to 110 plug-in systems that convert gasoline-powered trucks into electric hybrids. Both SDG&E and SoCalGas have set goals for their fleets: by 2020, 51 percent of SoCalGas' fleet and 22 percent of SDG&E's fleet are to run on alternative fuels.

SoCalGas issued a public advisory asking customers to immediately reduce their natural gas use to help lower the risk of natural gas and electricity shortages. The CPUC ordered the creation of this "SoCalGas Advisory program" to help address concerns about regional energy reliability stemming from the continuing moratorium on natural gas injection at the Aliso Canyon natural gas storage facility.

SoCalGas announced that its power-to-gas pilot program successfully converted surplus clean energy into hydrogen. Hydrogen can be blended with natural gas, providing a use for excess renewable electricity that would otherwise go to waste.

Sempra Renewables completed construction of Copper Mountain Solar 4 in Boulder City, Nev.; Mesquite Solar 2 in Tonopah, Ariz.; and Black Oak Getty Wind in Stearns County, Minn. Combined, these projects can produce 272 megawatts of clean, renewable power.

At year-end, half of the generating capacity across all Sempra Energy businesses came from solar, wind and hydroelectric power plants.

Strategy and assets

Sempra Energy, based in San Diego, is a Fortune 500 energy services holding company with 2016 revenues of more than \$10 billion. The Sempra Energy companies' more than 16,000 employees serve approximately 32 million consumers worldwide.

Sempra Energy is organized into two operating groups: Sempra Utilities and Sempra Infrastructure. Sempra Utilities includes SDG&E, SoCalGas and Sempra South American Utilities. Sempra Infrastructure includes Sempra Mexico, Sempra LNG & Midstream and Sempra Renewables.

We believe our balanced portfolio of businesses - long-term contracted energy infrastructure assets and regulated utilities - will continue to perform well in a variety of market conditions. A range of industry and market trends support this assessment:

- Increasing investment in utility safety and reliability;
- Electric grid modernization powered by new technology and additional renewable energy resources;
- Electrification of the transportation sector;
- Increasing worldwide demand for LNG; and
- Growing energy demand in Latin America, creating the need for new energy infrastructure.

Consolidated data

Dollars in millions, except per-share amounts

	2014	2015	2016
Revenues	\$11,035	\$10,231	\$10,183
Earnings	\$1,161	\$1,349	\$1,370
Adjusted earnings¹	\$1,182	\$1,298 ²	\$1,267
Earnings per share of common stock:			
Basic	\$4.72	\$5.43	\$5.48
Diluted	\$4.63	\$5.37	\$5.46
Adjusted diluted¹	\$4.71	\$5.21 ²	\$5.05
Weighted average number of common shares outstanding (diluted, in millions)	250.7	250.9	251.2
Total assets	\$39,651	\$41,150	\$47,786
Common dividends declared per share	\$2.64	\$2.80	\$3.02
Debt to total capitalization	54%	54%	53%
Book value per share	\$45.98	\$47.56	\$51.77
Capital expenditures & investments	\$3,363	\$3,356	\$5,796

¹ Sempra Energy adjusted earnings and adjusted diluted earnings per share are non-GAAP financial measures (GAAP represents accounting principles generally accepted in the United States of America). For an explanation and reconciliation of these non-GAAP financial measures, see "Reconciliation of Sempra Energy Non-GAAP Earnings and Diluted Earnings Per Share (Unaudited)" on page 69 of this report.

² Adjusted earnings and adjusted diluted earnings per share for the year ended December 31, 2015 have been revised to include after-tax LNG development expenses of \$10 million for consistency with 2016. LNG development expenses are included in adjusted earnings and adjusted diluted earnings per share in 2016.

Sempra Energy's values and code of conduct (see p. 14) guide the implementation of our business strategy. We strive to be a responsible partner: ethical, respectful, high-performing and forward-looking. We engage with our stakeholders - our customers, employees, investors, business partners, regulators and the communities we serve - and consider and incorporate their feedback when we can, building trust and strengthening relationships.

Sempra Utilities

Southern California Gas Company: SoCalGas has the largest customer base of any U.S. natural gas distribution utility, providing safe, reliable and affordable service to 21.7 million consumers.

San Diego Gas & Electric: SDG&E is an electric and gas utility that provides safe and reliable energy to 3.6 million consumers in San Diego and southern Orange Counties.

Sempra South American Utilities: The Sempra South American Utilities are Chilquinta Energía in Chile and Luz del Sur in Peru. Both utilities invest in electric infrastructure that provides energy to more than 7.2 million consumers.

Sempra Infrastructure

Sempra Mexico: Sempra Mexico includes IEnova, one of the largest private energy companies in Mexico. IEnova develops, builds, operates and invests in energy infrastructure in Mexico.

Sempra LNG & Midstream: Sempra LNG & Midstream develops and builds liquefied natural gas facilities, midstream natural gas infrastructure and natural gas storage.

Sempra Renewables: Sempra Renewables is a leading U.S. developer of renewable energy. Together with its partners, the company owns and operates nearly 2,400 megawatts of renewable energy capacity.

Sempra South American Utilities, Sempra Infrastructure, Sempra LNG & Midstream, Sempra Renewables, Sempra Mexico and Infraestructura Energética Nova, S.A.B. de C.V. (IEnova) are not the same as the California Utilities, San Diego Gas & Electric Company (SDG&E) or Southern California Gas Company (SoCalGas), and are not regulated by the California Public Utilities Commission.



Electric vehicles at SDG&E's Century Park office complex in San Diego, Calif.

Our energy assets

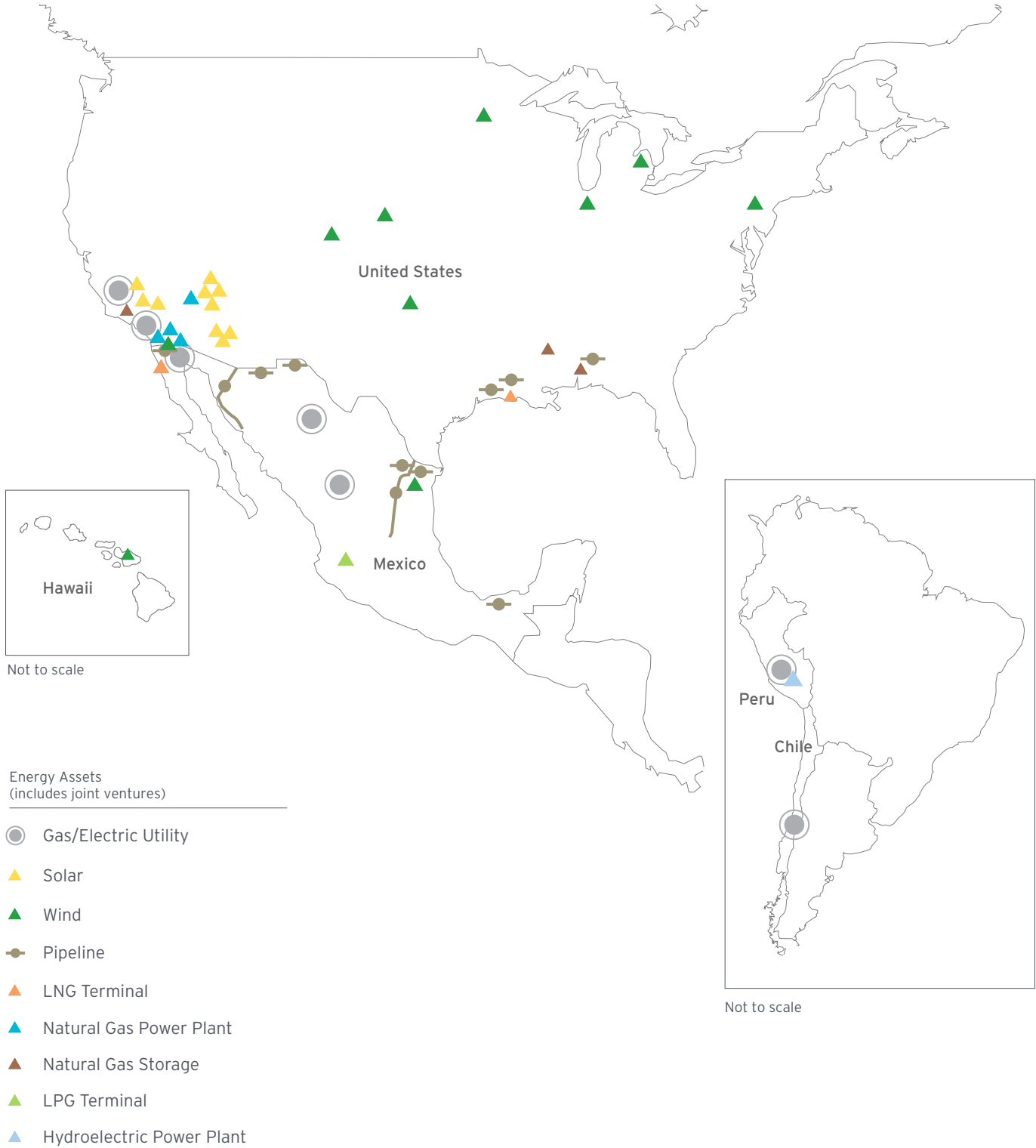

Nearly **70 percent** of the members of our board of directors are women and/or people of color.



We think strategically and critically, with an eye toward the future.

Governance

Board of directors

The business and affairs of Sempra Energy are managed under the direction of the Sempra Energy board of directors, our company's highest governing body. The members of our board have a fiduciary responsibility to Sempra Energy and its shareholders to act in their best interests.

Our board provides diverse and independent leadership. With the exception of our CEO, all members of our board are independent according to the principles and standards established by the New York Stock Exchange.

As of December 31, 2016, six of the 11 members of our board were women or people of color. The average board tenure was 8.5 years: six of the 11 members had tenure of fewer than six years; one had tenure of eight years; and four had tenure exceeding 13 years.

In the first half of 2017, the gender, ethnic and tenure diversity of our board increased, as we appointed three new directors and one director retired. As of May 15, 2017, nearly 70 percent of the members of our board of directors were women and/or people of color.

Our board reviews business plans and performance; reviews succession planning; and establishes corporate governance policies that guide Sempra Energy's operations. Our board has oversight of risk management with a focus on the most significant risks facing Sempra Energy, including strategic, operational, financial, legal and compliance risks. Throughout the year, the full board and its committees meet to review and discuss specific risk topics in greater detail.

The board is organized into five standing committees: the Audit Committee; the Compensation Committee; the Corporate Governance Committee; the Environmental, Health, Safety and Technology (EHS&T) Committee; and the Executive Committee. The EHS&T Committee is responsible for oversight of corporate responsibility, including review of environmental, health and safety programs and performance, as well as review of new technologies and topics such as cybersecurity management. The EHS&T Committee reviews Sempra Energy's annual corporate responsibility reporting efforts and is briefed on sustainability disclosure trends and initiatives.

Board member tenure¹

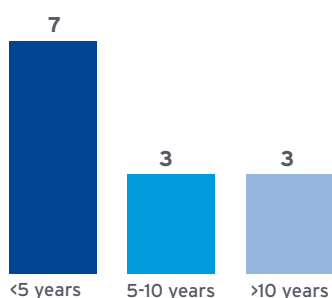

¹ As of May 2017

Our board members have the skills and experience relevant to managing a large multinational energy services holding company.

Our board members have the skills and experience relevant to managing a large multinational energy services holding company, including in the following areas:

- Energy distribution and generation
- Real estate
- International business
- Executive experience
- Oil and gas industry
- Engineering
- Public sector and regulation
- Information technology
- Infrastructure development
- Finance and investment
- Risk management
- Legislative and public policy

Shareholder engagement

Sempra Energy's board is accountable to shareholders. Each year, in conjunction with our annual meeting, shareholders have the opportunity to elect each member of our board of directors; to approve the selection of our independent public accounting firm; and to cast an advisory vote on the company's executive compensation program.

In addition to these recurring votes, a shareholder who has held \$2,000 of voting shares of Sempra Energy stock for at least one year may submit one proposal per year with respect to how we conduct business. These proposals are either: published in our annual proxy statement and voted on by shareholders in conjunction with the annual meeting; excluded, according to U.S. Securities and Exchange Commission guidelines; or withdrawn by the shareholder. The board may also submit proposals for shareholder consideration.

Proxy vote summary

Proxy item	Percent vote "For" ¹				
	2013	2014	2015	2016	2017
Election of directors (average) ²	95	99	99	96	99
Ratification of independent auditors ²	99	99	99	99	99
Advisory vote on executive compensation ²	87	97	97	71	98
Frequency of executive compensation vote (every year) ³	-	-	-	-	90
Independent board chairman	19	-	16	-	-
Long-term incentive plan ²	96	-	-	-	-

¹ Defined as For/(For + Against), expressed as a percentage. Abstentions and broker non-votes are not included in the calculation.

² Proposals submitted by the board.

³ Options to vote every two years and every three years received 0.25 percent and 9.75 percent of the vote, respectively.

In 2016, as part of our investor relations outreach, we met with shareholders representing 33 percent of our total outstanding shares (approximately 43 percent of our institutional share ownership) to discuss a range of environmental, social and governance issues, including the Aliso Canyon natural gas leak, methane emissions, executive compensation and the company's long-term incentive plan.

We reviewed and clarified our approach to a variety of issues, including:

Executive compensation: Following the "say-on-pay" vote at our 2016 annual meeting, we conducted extensive shareholder engagement to gather feedback on our compensation program, and made a number of refinements. The Compensation Committee now uses two distinct peer groups for the purposes of determining Long Term Incentive Plan (LTIP) performance: the S&P 500 Utilities Index and the S&P 500 Index. The Committee also now excludes stock buybacks not contemplated in the company's five-year financial plan from the earnings-per-share growth that is used to determine LTIP performance.

In addition to these changes to our compensation program, the committee also did not increase our CEO's salary or total target compensation for 2017. More details can be found in our [proxy statement](#).

Board refreshment: Our annual proxy statement now includes the number of members of our board with fewer than five years; five to 10 years; and more than 10 years of service. Prior proxy statements used broader categories.

Values and code of conduct

At Sempra Energy, our work is guided by our values. What we do is important, but how we do it is even more critical. We act with honesty and integrity. We listen to and engage with others and seek diverse perspectives. We set and achieve tough goals. And we think strategically and critically, with an eye toward the future.

Corporate values

What we do is important, but how we do it is even more critical.

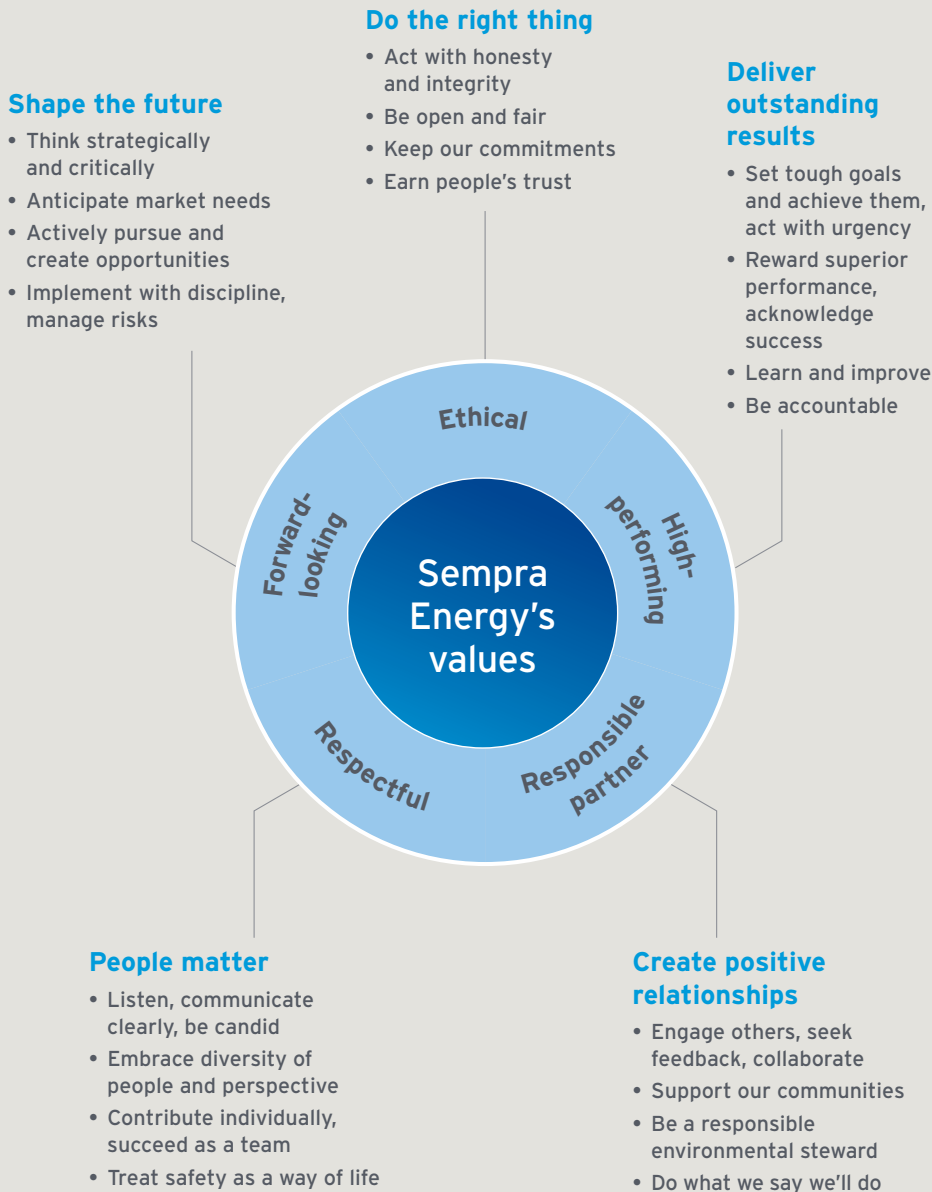

Every employee regularly completes ethics and compliance training, customized to their position and responsibilities.

We expect each Sempra Energy director, employee and supplier to abide by our values - and also to understand and comply with our Code of Business Conduct (Code).

Our Code covers a wide range of topics, including safety; discrimination- and harassment-free workplace; confidentiality and privacy; environmental protection; charitable activities; political participation; anti-trust, anti-corruption and bribery; fair competition; conflicts of interest; information management; and securities trading.

Our commitment to responsible and ethical behavior is further detailed in a range of corporate policies and position statements, including our Discrimination- and Harassment-Free Workplace Policy, our Environmental Policy, our Climate Change and Air Emissions Position Statement, our Political Engagement and Contributions Policy and many others.

Every employee regularly completes ethics and compliance training, customized to their position and responsibilities.

Employees, contractors, customers and suppliers can report a potentially unsafe, unethical or compliance-related concern without fear of retaliation. To encourage this, Sempra Energy provides a wide range of reporting channels.

Employees may report a concern to: their immediate supervisor; the next level of management above their supervisor; the corporate compliance department; the human resources department; our chief ethics officer, currently Senior Vice President, Chief Human Resources and Administrative Officer G. Joyce Rowland; or the Ethics & Compliance Helpline. Or they may take other actions as outlined in our Code of Business Conduct.

Any contractor, supplier, employee or member of management who does not comply with applicable laws or corporate policies is subject to disciplinary action, including termination.

Any stakeholder, including an employee, contractor, customer or supplier, may report a concern or grievance - anonymously, if desired - via the Ethics & Compliance Helpline, available 24 hours a day, seven days a week. Every report made to the Ethics & Compliance Helpline is investigated. The helpline can be accessed in the following ways:

- SempraEthics.com
- United States: 800-241-5689
- Mexico: 001-770-582-5249
- Chile: 600-320-1700
- Peru: 0800-7-0690

Political involvement

Representatives from Sempra Energy and its businesses interact with policymakers at the federal, state and local level. They participate in meetings; testify before committees; write letters in support of, or in opposition to, proposed policies; and make political contributions as allowed by law.



California State Assembly Speaker Anthony Rendon shares thoughts with Sempra Energy employees.

The company and its businesses also maintain memberships in various business and trade associations that advocate on public policy.

In 2016, Sempra Energy reported aggregated lobbying expenditures across its companies, excluding political contributions, of \$3,937,595 at all levels of government. Lobbying expenses include time and expenses incurred in the course of lobbying; expenses related to the operation of our offices in Washington, D.C., and Sacramento, Calif.; fees paid to lobbying firms; and the lobbying portion of fees we paid for membership in business or trade organizations. In addition to lobbying expenses, Sempra Energy and its companies made \$995,689 in campaign contributions to state and local candidates and political committees and caucuses, as allowed by law. Sempra Energy does not make political contributions to federal candidates or outside the United States.

The Sempra Energy Employees' Political Action Committee (SEEPAC) supports candidates and elected officials, regardless of political party, who are open to learning about and addressing the issues our industry faces. In 2016, SEEPAC made \$232,250 in political contributions, in compliance with the requirements governing political action committees.

Twice a year, we publicly disclose, corporate and SEEPAC political contributions as well as fees of \$20,000 or more that were paid for memberships in business and trade associations, specifying the amount of such fees that were attributable to lobbying.

In 2016, Sempra Energy received the highest score for transparency on the Center for Political Accountability's CPA-Zicklin Index, a ranking that benchmarks the political disclosure and accountability policies and practices of leading U.S. companies.

Cybersecurity risk and mitigation

Cybersecurity is a priority at Sempra Energy. In addition to the cyber risks that all corporations face, the utility industry faces evolving cybersecurity risks associated with protecting confidential customer information and electric and gas system infrastructure. An attack on our information systems or the electric or natural gas system infrastructure could have a material adverse effect on our businesses, cash flows, financial condition, results of operations and/or prospects. The theft, damage or improper disclosure of sensitive electronic data could subject us to penalties for violation of applicable privacy laws; subject us to claims from third parties; require compliance with notification and monitoring laws, regulations and requirements; and harm our reputation.

Cybersecurity and related risks for the company are overseen by the company's senior leadership through the Compliance and Enterprise Risk Committee. The Committee is chaired by Joe Householder, corporate group president of infrastructure businesses, and Steven Davis, corporate group president of utilities. In March 2017, Sempra Energy announced the appointment of P. Kevin Chase as chief information officer. Mr. Chase has responsibility for the physical and cyber security of the Sempra Energy family of companies.

Risk management

To develop and deliver safe, reliable and affordable energy and energy services to approximately 32 million consumers, our company and its businesses must prepare for adverse events and uncertainties. We take this responsibility very seriously.

Key risks

Sempra Energy identifies, assesses and, where possible, mitigates a broad and complex set of risks commonly associated with the energy industry, as well as risks specific to our company. Our [Annual Report on Form 10-K](#), filed each year with the U.S. Securities and Exchange Commission, provides a description of these risks.

Types of risk assessed include financial risks; operational risks, including safety and cybersecurity risks; regulatory and compliance risks; and other risks. Examples are listed below.

- Safety risk - There are inherent public and employee safety risks associated with operating energy generation, processing, transmission and distribution facilities.
- Financial risk - Sempra Energy's cash flows, ability to pay dividends and ability to meet its debt obligations largely depend on the performance of its businesses and the ability to utilize the cash flows from its businesses.
- Operational risk - Severe weather conditions, natural disasters, catastrophic accidents or acts of terrorism could materially adversely affect our businesses, financial condition, results of operations, cash flows and/or prospects. (SoCalGas President and Chief Operating Officer Bret Lane discusses the Aliso Canyon natural gas leak on [page 36](#).)
- Cybersecurity risk - The malicious use of technology could present a risk to our information systems and the integrity of our energy grid and our natural gas pipeline infrastructure and storage facilities.
- Regulatory risk - Our businesses are subject to complex government regulations and may be materially adversely affected by changes in these regulations or in their interpretation or implementation.
- Reputational risk - The reputation of our companies is fundamental to our license to operate in or near communities. This includes impacting our ability to site projects and receive needed approvals and permits from local governments and regulatory and permitting agencies.
- Compliance risk - Our businesses incur environmental compliance costs, and future environmental compliance costs could have a material adverse effect on our cash flows and results of operations.
- Climate change risk - A combination of other risks: A changing climate could have operational, regulatory and reputational impacts on our businesses. A more detailed description of climate risk is on [page 23](#).

Risk management process

At Sempra Energy, we assess a risk based on its ability, probability and potential to have a significant adverse impact on our business.

We take a rigorous approach to risk management. We use a risk framework and risk registry to assign and track risks internally. We also use a range of tools and methods, including risk maps, risk composition, risk correlation and sensitivity analysis. We look to mitigate, share or transfer risk where appropriate through methods such as operational enhancements; sharing counterparty/liquidity risk in joint ventures; use of guarantees or long-term contracts; insurance; and risk indemnification.

Risk management teams from across the company use this approach. For each identified risk, the teams assess the potential impact, likelihood of the event and strength of controls. Once a risk has been assessed, risk managers work to mitigate it.

Each principal business' risk management department reports directly to its CEO, chief operating officer and/or chief risk officer - and reports both risks and risk mitigation strategies to its board of directors. Sempra Energy's corporate risk management department reports to the chief financial officer - and reports aggregated risks to the Sempra Energy board of directors.

Effective risk management is essential to maintaining the stable operation of our businesses - and to achieving strong and predictable business outcomes.

Risk mitigation in Cleveland National Forest

A team of hundreds of SDG&E employees are working to fire-harden portions of the utility's electrical distribution system in an 880 square-mile high-risk fire area of San Diego's backcountry. Similar work has been completed in other areas of the utility's service territory.

Crews are replacing more than 2,200 existing wood poles with steel poles. These steel poles resist fire and also allow for increased spacing between wires, reducing the risk of fire from wire-to-wire contact caused by strong winds. Crews are replacing existing conductors (power lines) with stronger steel-core conductors. Crews are also placing approximately 13 miles of power lines underground. All of these activities improve system resilience and mitigate fire risk.

The project utilizes sophisticated Geographic Information System (GIS) technology to provide information on each specific area of the project to all the people working on it. Work is being overseen by more than 40 environmental monitors. The project even has its own fire prevention plan.

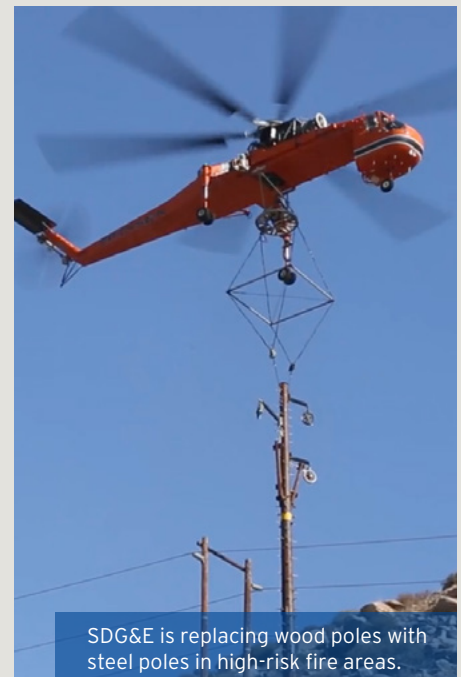

SDG&E is replacing wood poles with steel poles in high-risk fire areas.

By tracking compliance performance and key metrics, we protect our company from exposure to unnecessary risk.

Compliance and management systems

As an energy services holding company, Sempra Energy expects its businesses to utilize effective processes and systems to optimize performance and ensure compliance with company policies and all applicable laws, rules and regulations. By tracking compliance performance and key metrics, we protect our company from exposure to unnecessary risk and help ensure strong performance.

At the core of our compliance processes is our “tone from the top,” which is highlighted in our [Code of Business Conduct](#) - integrity, honesty and respect. But we believe tone from the top is not enough. We expect all employees to embrace our values and our commitment to compliance and ethical behavior.

A wide range of processes and management systems help us achieve compliance. These are based on the following core elements:

- **Leadership oversight and accountability** - Our senior leadership team is committed to promoting and enhancing our culture of compliance. Our company has designated chief compliance officers and related oversight committees to oversee compliance programs at the parent company as well as at each principal business.
- **Standards of conduct, policies and procedures** - Our company has a Code of Business Conduct for directors, employees and suppliers. We also keep our policies up-to-date, and communicate on a regular basis to those impacted.
- **Education, communication and awareness** - Our company has implemented a risk-based program to provide education and communication on a variety of compliance topics. Training courses are customized according to each employee's position and responsibilities. Compliance personnel can monitor employee comprehension of key compliance principles, and can make changes to course curricula to improve training effectiveness.
- **Risk assessments, auditing and monitoring** - Our company completes an enterprise-wide risk assessment each year. The risk assessment is one of our key inputs into the development of our annual internal audit plan. In addition, each compliance program designs and implements processes to monitor effectiveness and implement improvements.
- **Establishment of reporting processes and procedures** - Anyone may anonymously report ethics and compliance concerns, grievances or potential violations through our Ethics & Compliance Helpline, available 24 hours a day, seven days a week. Every report made to the Helpline is investigated in a timely manner. More information on the Helpline is on [page 16](#).

To support the production and publication of our corporate responsibility report, we use an enterprise-wide system to collect, aggregate and analyze emissions, environmental compliance, water, safety, diversity and other types of data from Sempra Energy's businesses. These data are also used to develop and review companywide performance objectives, responsibilities and deadlines.



Supplier selection and monitoring

Supplier selection and monitoring* is an important aspect of risk management at Sempra Energy. Our businesses must provide reliable energy and energy services to their customers. They need suppliers that can deliver essential equipment, parts and services - even in adverse conditions.

Procurement procedures and policies guide our businesses as they select and monitor suppliers and business partners. Working with a wide range of suppliers (small, mid-sized and large companies; new as well as more established companies; and companies with operations in different locations) helps ensure system reliability, and results in better service and lower costs.

Once a supplier has been selected, supply chain managers monitor performance to assess whether a particular company delivers goods or services as expected and whether their operations are in alignment with Sempra Energy's values and standards. This includes acting with integrity (suppliers are subject to anti-corruption review); complying with applicable laws and regulations; achieving strong health and safety performance; respecting employee rights; and minimizing impacts on the environment. We provide each of our suppliers with a copy of our Code of Business Conduct, which is also posted on sempra.com.

To complement the work of supply chain managers, our Audit Services group conducts supplier audits, reviewing safety procedures and performance; training programs; subcontracting policies; and other areas.

Information on how to do business with Sempra Energy companies can be found on sempra.com.

Examples of compliance and management systems

Sempra Energy and its businesses utilize many different programs, processes and management systems to optimize compliance performance.

- Our Audit Services department, which reports directly to the Sempra Energy board of directors, completed 120 audits in 2016, reviewing business practices and identifying possible improvements.
- Cybersecurity-focused employee communications, one-click reporting and other tracking and reporting tools help protect company assets.
- Our California utilities (SDG&E and SoCalGas, collectively) use an environmental and safety compliance management program to ensure compliance with environmental and safety laws; rules and regulations; and company standards. Our other businesses utilize ISO14001 and other international standards.
- Business resumption plans outline how we will recover and resume operations following a natural or human-caused disaster or other unforeseen disruption.
- We use a lobbying activity tracking system to manage political activity and meet local, state and federal political reporting requirements.

*Information on the impact of our supply chain may be found on [page 44](#).

The environment



The 150-megawatt Mesquite Solar 1 facility in Tonopah, Ariz.

Climate change 22

Climate change risk

Actions to reduce emissions

Emissions 30

Water 38

Waste and recycling 40

Environmental compliance 42

Biodiversity 43

Supply chain impacts 44

Climate change

Sempra Energy is concerned about climate change. That's why we've been developing low-carbon energy infrastructure and reducing emissions across our portfolio for more than a decade.

We see great opportunity in addressing climate change. A range of industry and market trends indicate that demand for energy, including lower-carbon energy and energy-related services, will continue to increase. These trends include:

- Increasing investment in utility safety and reliability;
- Electric grid modernization powered by new technology and additional renewable energy resources;
- Electrification of the transportation sector;
- Increasing worldwide demand for LNG; and
- Growing energy demand in Latin America, creating the need for new energy infrastructure.

As we work to meet the demands of this marketplace, we simultaneously reduce emissions. A description of the many ways we do this is on [page 26](#). A list of our emissions-reduction milestones is on [page 25](#).

We also manage a wide range of risks associated with climate change.

Climate change risk

A changing climate has regulatory, operational and reputational impacts on our business.

Regulatory climate risk: Sempra Energy's businesses are subject to many rules and regulations that require us to limit our greenhouse gas emissions. Many of these regulations are related to increasing concerns about climate change.

We are required to obtain permits, licenses, certificates and other approvals to operate our businesses and disclose our environmental impact. Failure to comply with these requirements could subject our businesses to substantial penalties and fines - and might result in the significant curtailment of our operations.

The way we operate our infrastructure helps to mitigate these risks. Our natural gas power plants are built with the latest emissions-control technology. Our solar and wind assets require negligible amounts of water to operate. And we work to operate our natural gas infrastructure safely and efficiently, protecting the integrity of our pipelines and other assets.

Operational climate risk: Climate change could exacerbate physical risks to our infrastructure. Rising temperatures, drought conditions and extreme winds can impact our operations in the Southwest United States.

SDG&E customers can choose 100 percent renewable energy

With just a few clicks, and for just a few dollars more per month, SDG&E customers can now opt to have 100 percent of their electricity come from renewable sources through a program called EcoChoice.SM

Here's how it works:

- An interested customer estimates their monthly cost using the calculator at sdge.com/EcoChoice and enrolls in the program online;
- SDG&E purchases renewable power; and
- The customer begins receiving power attributable to* renewable sources.

Customers can specify how much of their power will come from renewable sources - from 50 percent to 100 percent.

SDG&E already delivers power from renewable sources (43 percent at year-end 2016). EcoChoice provides a simple way for customers to be even greener, and increase that amount to 50 percent, 60 percent or even 100 percent.

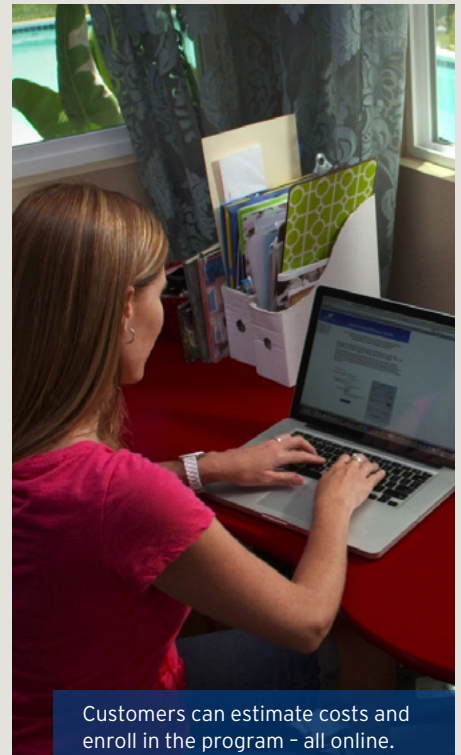

Customers can estimate costs and enroll in the program - all online.

* Note: SDG&E purchases this electricity specifically for EcoChoice customers, but delivers it using its electrical grid, a system that carries power from a range of sources.

Hurricanes and flooding can impact our operations in the Gulf Coast. Sea level rise can impact operations in both of these areas.

We mitigate these risks by strengthening our infrastructure. This includes repositioning electric lines underground (where they are not exposed to vehicles, tree branches or other potential sources of trouble); converting power poles from wood to steel; working to prevent wildfires, including vegetation management (tree trimming); monitoring and predicting the weather with company meteorologists and an extensive system of weather stations (in SDG&E's service territory); preparing the communities where we work for possible disasters or unforeseen events; and training our employees.

We also prepare for possible longer-term impacts of climate change by incorporating climate change projections into our planning process for upgrading or building new facilities.

Reputational climate risk: At Sempra Energy, we set clean energy targets. We implement energy-efficiency incentives and technologies to help our customers minimize their emissions and reduce their costs. We also work to operate our infrastructure safely and efficiently.

We face reputational risk if we miss these targets; if new technologies do not perform as expected; or if we encounter unforeseen challenges as we integrate new types of energy into the grid (renewables, storage and customer-generated energy). Moreover, events such as changing or extreme weather conditions, natural disasters, equipment failures, catastrophic accidents or other events might impact our infrastructure, our customers and our reputation.

We mitigate these risks by identifying strategies, making investments and taking actions that help us meet our targets; by exploring and investing in many different technologies; and by encouraging regulators to allocate costs fairly given the rapid transformation that is occurring in our industry.

For a more detailed discussion of Sempra Energy's climate risks and opportunities, please see our response to CDP's annual climate change survey at www.cdp.net.



SDG&E meteorologists work to monitor and predict the weather.

Emissions-reduction milestones

At Sempra Energy, we develop low-carbon energy infrastructure and reduce emissions.

- Coal has not been a part of our power-generation portfolio for over a decade.
 - Sempra Renewables launched the first utility-scale photovoltaic (solar) generation facility in the U.S. in December 2008.
 - SDG&E became the first fully smart-meter-enabled utility in the U.S. in 2012. Smart meters help customers become more energy-efficient.
 - Sempra Renewables' Auwahi wind farm, which went into service in 2012, was one of the first integrated storage-wind projects in the country.
 - In 2015, SDG&E's Borrego Springs microgrid became the first in the nation to leverage renewable energy to power an entire residential community.
 - SDG&E was the first investor-owned utility to achieve California's 33-percent renewable energy mandate. The utility met the target in 2015, a full five years before the deadline.
 - SoCalGas worked with partners to develop a near-zero-NOx-emissions heavy-duty engine fueled by natural gas. The engine, the first of its kind, was deployed commercially in 2016.
 - SDG&E, with partners, is responsible for one of the largest lithium-ion grid-connected battery systems of its kind in the world. The 30-megawatt system became operational in early 2017.
 - Our California utilities have installed advanced meters throughout their service territories. These meters gather data remotely, eliminating the fleet vehicle emissions associated with in-person meter reading.
 - At year-end 2016, half of the generating capacity across all Sempra Energy businesses came from solar, wind and hydroelectric power plants.
- In addition to these milestones, Sempra Energy's businesses continue to innovate.
- SDG&E is involved in a demonstration project that would allow electric vehicle owners to provide battery power to the electrical grid.
 - SoCalGas, in collaboration with the University of California at Irvine, is testing a power-to-gas system that creates hydrogen gas from water through a chemical reaction known as electrolysis. The hydrogen gas, which is carbon-free, can be blended with natural gas to create a lower-emissions fuel source.
 - A Sempra Renewables start-up unit is developing software that allows utilities to more easily integrate renewable energy into the electric grid.
 - SoCalGas is exploring ways to add dairy biogas to its natural gas distribution system. This would offset a significant amount of greenhouse gas emissions: California's dairies release nearly 20 million metric tons of CO₂e into the atmosphere each year. (See p. 26 for definition of CO₂e.)

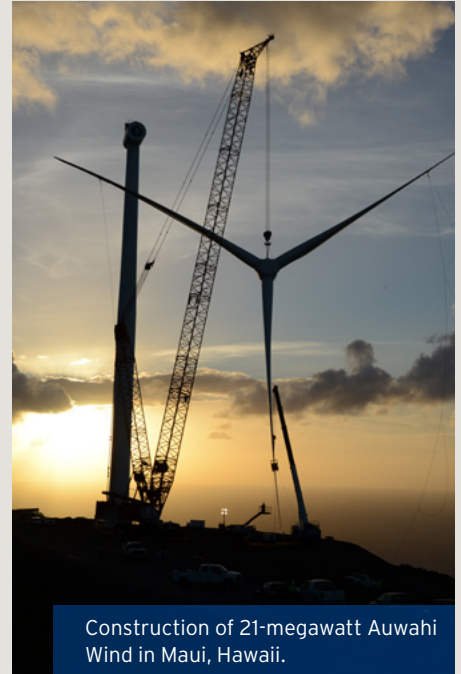

Construction of 21-megawatt Auwahi Wind in Maui, Hawaii.

What is CO₂e?

Not all greenhouse gases have the same impact on the environment. For example, one unit of methane has approximately 25 times the impact of one unit of carbon dioxide. To make it easier to quantify greenhouse gas emissions, organizations and businesses calculate and report their emissions as carbon-dioxide equivalent (CO₂e) to accurately describe the cumulative impact of the different types of greenhouse gases they emit.

Actions to reduce emissions

We work to reduce our emissions and those of our customers.

We build and operate natural gas and LNG infrastructure. Natural gas is the cleanest fossil fuel and is increasingly available and affordable. Our Mexico business, IEnova, operates and is developing natural gas pipelines that will make natural gas a viable and cleaner option for industrial users and power generators in Mexico. Also, when it is liquefied, natural gas can be transported over long distances and provide end users with a cleaner alternative to fuel oil or coal. Our work with our partners to develop LNG infrastructure may bring this lower-carbon fuel to countries that currently rely on fuel oil or coal. Over time, these activities could contribute in a meaningful way to a reduction in global greenhouse gas emissions.

We use natural gas instead of coal in our power plants. In 2016, our businesses' natural gas-fired power plants generated more than 6 million megawatt-hours of "always-on" electricity, emitting some 2.6 million metric tons of carbon dioxide equivalent (CO₂e) - roughly half what would have been produced if that power had been supplied by coal-fired power plants. We have not owned coal-fired generation assets for more than a decade.

We generate energy using renewable sources. In 2016, our businesses, with their partners, generated about 6 million megawatt-hours of emissions-free renewable electricity. (Traditional power plants, producing the same amount of power, would have emitted more than 3 million metric tons of carbon dioxide.)

We purchase and deliver renewable energy. In 2016, 43 percent of the energy SDG&E delivered to its customers came from renewable sources, far exceeding the regulatory requirement that it deliver 33 percent renewable energy by 2020.

We build and invest in emissions-free energy infrastructure. Since 2008, we have developed or invested in projects in North America that can produce more than 2,700 megawatts of renewable energy. We anticipate that projects representing an additional 274 megawatts will begin operation by year-end 2019. Our Luz del Sur subsidiary in Peru operates the Santa Teresa hydroelectric plant which can produce 100 megawatts of clean energy. As the cost of developing renewable energy continues to fall, it will represent a greater proportion of the energy mix.

We improve the efficiency of energy infrastructure, including our natural gas pipelines and storage facilities. We minimize the amount of energy and water needed in operations. And our businesses inspect and repair or replace natural gas pipelines and related equipment to improve safety and reduce emissions.

We encourage our customers to save energy or to shift their energy use to off-peak hours. Energy-efficiency measures save hundreds of thousands of megawatt hours of electricity and tens of millions of therms of natural gas each year. Improving energy efficiency is one of the easiest and lowest-cost ways of reducing energy use and associated greenhouse gas emissions. In some of our utility operations, we also implement time-of-use rates for customers, offering incentives to use energy when demand is low, and minimizing the need to deploy higher-emission peaker power plants to generate energy.

We use clean transportation and develop the infrastructure that allows our customers to do the same. SoCalGas and SDG&E have said that, by 2020, 51 percent and 22 percent of their fleets, respectively, will use alternative fuels. In 2016, SDG&E received approval from the CPUC to install up to 3,500 electric vehicle charging stations to facilitate customer transition to electric vehicles. SoCalGas is working to expand the availability of natural gas (including methane captured from organic sources, also known as renewable gas) as a low-carbon fuel source. In 2016, San Diego's Metropolitan Transit System moved its fleet to 100 percent renewable gas.

We integrate new technologies into our operations. The smart grid integrates battery storage; advanced meters (which transmit customer usage data to utilities and eliminate the emissions from fleet vehicles used for manual meter reading); smart devices, such as thermostats; home energy management systems; electric vehicles; and electric vehicle charging stations; allowing our utilities to more precisely deliver energy when and where it is needed. For additional examples of innovation, please see the "Emissions-reduction milestones" sidebar on [page 25](#).

Growing tomatoes, with an assist from SoCalGas

New technologies are changing the way our customers use electricity and natural gas. One example comes from Houweling's Tomatoes and Nursery in Camarillo, Calif. Houweling's 125-acre greenhouse uses a combined heat-and-power system that generates electricity, heat and condensed water, and repurposes carbon dioxide to benefit crop production.

Here's how it works: Three on-site internal-combustion engines generate heat and electricity for the greenhouse, including its 24/7 grow lights. Excess heat from the engines heats the greenhouse. Carbon dioxide from the exhaust system increases crop production. And condensed water produced by the exhaust system (up to 9,500 gallons per day) helps water the plants. The nursery also sells excess electricity from the system back to the grid.

SoCalGas demonstrated this system to show agricultural companies how they can meet California's stringent air quality compliance regulations, while increasing efficiency and cutting operational costs.



Houweling's 125-acre greenhouse is both innovative and efficient.

At year-end, **half of the generating capacity** across all Sempra Energy businesses came from solar, wind and hydroelectric power plants.

Since 2006, we have publicly disclosed our greenhouse gas emissions. In 2016, we received an "A-" on our disclosure, reflecting the fact that Sempra Energy is utilizing best practices in reporting on greenhouse gas emissions and climate change risk.

Sempra Energy generating capacity by energy source

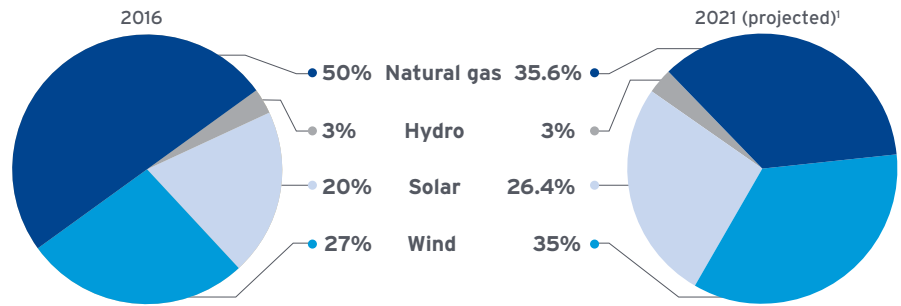

¹Includes all generation capacity planned or under construction as of June 15, 2017.



Weather-related impacts may intensify in the coming years.

Climate change resilience at SDG&E

SDG&E's energy infrastructure is subject to many weather-related impacts, projected to intensify in the coming years. To protect its ability to continue to deliver gas and electricity, SDG&E is strengthening its system. This includes incorporating the probability of sea-level rise into its planning process for coastal facilities; ensuring that electricity and natural gas distribution systems are prepared for both drought conditions and extreme rainfall; making the electric system more resistant to wildfire impacts; and ensuring that its systems can deliver electricity to cool homes and businesses during periods of extreme temperatures and high demand.

Individuals from 15 different departments participate in internal climate advisory group that evaluates and monitors climate-related risks. SDG&E also is collaborating with the U.S. Department of Energy and 18 other utilities through the Partnership for Energy Sector Climate Resilience.

Sempra Energy's position on U.S. energy policy



Complex energy infrastructure requires long lead times and significant financial investment.

Sound and stable policies are particularly important to the energy industry, given the long lead times and significant financial investment required to develop energy infrastructure.

Our position on U.S. energy policy is based on the following principles:

- We advocate for a balanced policy approach that ensures consumers have access to safe, clean, affordable and reliable energy. We support national energy policies that promote supply diversity, technological innovation, energy efficiency and sound environmental stewardship.
- We believe that we can develop energy resources while also protecting the environment. Both of these objectives can and must be achieved to help power our national economy, preserve and create jobs and protect our quality of life.
- We believe U.S. policy should address climate change and energy in a coordinated manner. Natural gas, renewable energy and the development of new energy technologies like batteries should play a central role in U.S. climate and energy policy.
- We support the efficient use of energy, including in the transportation sector where electric and natural gas vehicles play an increasingly important role. Greater energy efficiency improves energy security and reduces environmental impacts.
- We believe that government support of technology development is essential. Government investment in technical education as well as research and development encourages the advancement of emerging energy technologies, which often have a high level of technical risk and long lead times to market.
- We support the implementation of stable and sensible tax policies that encourage investment in energy infrastructure and spur innovation in nascent technologies.
- We advocate for sensible and consistent regulation of our industry. Changing, excessive, duplicative or potentially conflicting regulations can increase costs, delay government approvals and adversely impact investment decisions; all of which increase consumer energy prices.
- We advocate for a free- and fair-trade policy that breaks down foreign barriers to U.S. goods and services and addresses unfair foreign trade practices and imports. Our economy and national security benefit from the export and import of energy resources such as LNG.

Our scope 1 and scope 2 emissions decreased **20 percent***, year-over-year.

Emissions

At Sempra Energy, we work to reduce emissions and to identify and mitigate climate-change related risks.

In 2016, our scope 1 and scope 2 emissions (see [page 33](#) for definitions) were approximately 4.9 million metric tons of carbon-dioxide equivalent, also known as CO₂e (defined on [page 26](#)). This represents a year-over-year decrease of about 20 percent*, primarily due to less energy production at SDG&E's natural gas-fired power plants and the sale of the Mobile Gas and Willmut Gas utilities. We reported all emissions from the Aliso Canyon natural gas leak, which took place from October 2015 to February 2016, in our 2015 report - these emissions totaled approximately 2.1 million metric tons of CO₂e.

Sempra Energy's 2016 scope 3 emissions (emissions not directly associated with our operations) were approximately 52.8 million metric tons of CO₂e (see [page 33](#) for a definition of "scope 3" and [page 26](#) for a definition of "CO₂e"). This figure includes emissions from the generation of electricity that SDG&E purchased and delivered to its customers; emissions from our customers' combustion of natural gas delivered to them by our SoCalGas, SDG&E and Ecogas utilities; and emissions from employee air travel. Our reported scope 3 emissions do not include upstream emissions from natural gas production wells.

As required by state law, our California utilities purchase emissions allowances and offsets to cover emissions from power plants, natural gas compressor stations, purchased power imported from out of state and customer use of natural gas. When feasible, the utilities purchase offsets within the State of California.

*Excluding emissions from the Aliso Canyon natural gas leak



Scope 1 and 2 greenhouse gas emissions^{1,2,3}

Million metric tons of CO₂ equivalent

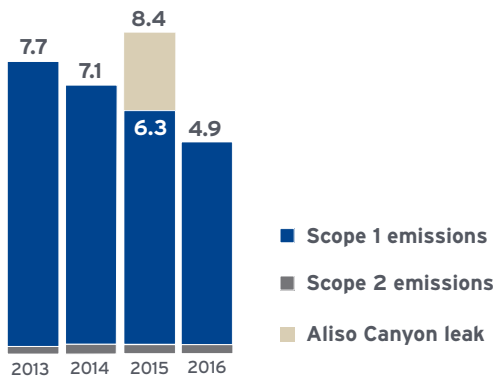

¹ Emissions from electric utility Luz del Sur are not included. Only some of the emissions from Cameron LNG and Chilquinta Energía are included. These entities do not currently track all of their emissions.

² 2016 emissions data are undergoing third-party verification and may be updated. 2015 emissions data have been updated following an independent verification.

³ The leak at the Aliso Canyon storage facility resulted in the loss of approximately 4.62 billion cubic feet of natural gas. Using the 100-year global warming potential (GWP) value of 25 for methane, this is equal to 2.1 million metric tons of CO₂ equivalent. This GWP comes from the Fourth Assessment Report of the Intergovernmental Panel on Climate Change and is consistent with the GWP used for estimates produced by the California Air Resources Board. We remain committed to fully mitigating the emissions impact of the natural gas lost.

2016 Scope 1 and 2 greenhouse gas emissions by source^{1,2}

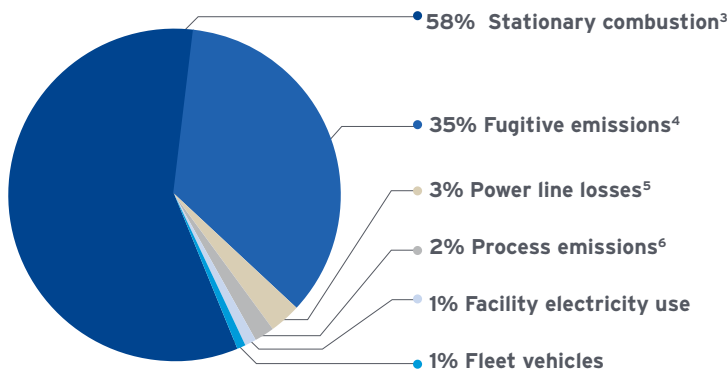

¹ Emissions from electric utility Luz del Sur are not included. Only some of the emissions from Cameron LNG and Chilquinta Energía are included. These entities do not currently track all of their emissions.

² 2016 emissions data are undergoing third-party verification and may be updated.

³ Emissions primarily from our natural gas power plants.

⁴ Emissions from leaks or other unintended releases of natural gas, excluding emissions from the Aliso Canyon leak. The leak at the Aliso Canyon storage facility resulted in the loss of approximately 4.62 billion cubic feet of natural gas. Using the 100-year global warming potential (GWP) value of 25 for methane, this is equal to 2.1 million metric tons of CO₂ equivalent. This GWP comes from the Fourth Assessment Report of the Intergovernmental Panel on Climate Change and is consistent with the GWP used for estimates produced by the California Air Resources Board. All emissions from the leak were included in our 2015 numbers.

⁵ Emissions from the generation of electricity that we lose during transmission and distribution.

⁶ Emissions from physical or chemical processes related to combustion.

Encouraging energy efficiency through our utilities

Under California state law, utility profits are not driven by the amount of energy sold. So SDG&E and SoCalGas work with their residential, business and industrial customers to determine ways they can save energy and reduce their energy bills. In 2016 alone, these energy-efficiency programs saved approximately 346,000 megawatt-hours of electricity, enough to power 57,627 homes for a year; and nearly 40 million therms of natural gas, enough to serve nearly 80,000 homes for a year. Both utilities are incentivized by regulators to meet or exceed energy-efficiency goals.

In Chile, our Chilquinta Energía business continued its energy-efficiency program named “Iluminados.” Customers in the cities of Valparaiso, Quilpué and Villa Alemana can have advanced meters installed in their homes or businesses - and can exchange older inefficient refrigerators for a reduced price on a new, more efficient (A+ or A++ rated) refrigerator.

Nearly 400 customers have benefited from Iluminados, achieving an average energy savings of 15 percent per household.

Reducing methane emissions at SoCalGas

Since the company joined the Natural Gas Star program in 1993, SoCalGas has implemented practices that have resulted in the reduction of more than 800,000 metric tons of CO₂e, the equivalent of removing 169,000 cars from the road for a year. As a result of these efforts, SoCalGas has one of the lowest methane emission rates of natural gas utilities in the U.S. (See sidebar on page 55 to learn more about natural gas pipeline testing and methane sensors at SoCalGas.)

For additional information on emissions, methane, safety and regulatory issues, please click below:

[Sempra Energy - Emissions](#)

[SoCalGas - Methane](#)

[SoCalGas - Safety](#)

[SoCalGas - Regulatory](#)

[SDG&E - Methane](#)

[SDG&E - Safety Enhancement](#)

[SDG&E - Safety & Reliability](#)

CO₂ emissions rate for power generation¹

Pounds of CO₂ per megawatt-hour

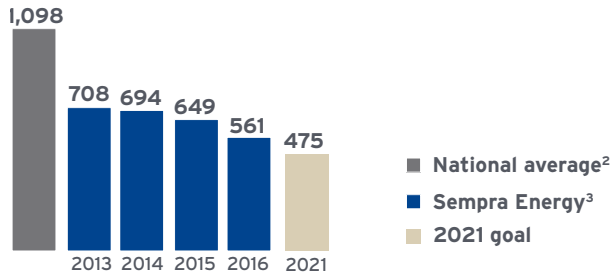

¹ 2016 emissions data are undergoing third-party verification and may be updated.

² Source: U.S. Energy Information Administration Electric Power Annual 2015.

³ Emissions rate of Sempra-owned generation on an equity share basis. Data from 8-megawatt Chilquinta Energía plant is not included.

Natural gas-fired power plants operated by Sempra Energy businesses represent our most significant source of direct (scope 1) greenhouse gas emissions. Yet these power generation operations are very efficient: In 2016, we emitted 561 pounds of carbon dioxide per megawatt-hour of electricity generated. This rate is half of the average U.S. emissions rate for power generation.

As we continue to develop and operate additional renewable energy resources, we expect that our total energy mix will become even cleaner and our power-generation CO₂ emissions rate will continue to decline.

In 2013, we set a target of achieving a rate of 658 pounds per megawatt hour or less by 2016, a 10-percent decrease compared with our 2010 baseline. We achieved this goal in 2015. We are now aiming to achieve a rate of 475 pounds per megawatt hour or less by 2021, a 35-percent decrease compared with our 2010 baseline. We are also looking into developing a science-based emissions-reduction target, aligned with the level of carbon-emissions reduction required to keep global temperature increase below 2 degrees Celsius compared with pre-industrial temperatures. More information on science-based targets is available at sciencebasedtargets.org.

Fugitive emissions (natural gas/methane emissions from leaks or other types of unintended or irregular releases) are our second most significant type of greenhouse gas emissions, behind emissions from stationary combustion. In 2016, fugitive emissions accounted for 94 percent of our methane emissions. Process emissions accounted for the remaining 6 percent. Our companywide methane emissions were 1.8 million metric tons of CO₂e: 1.5 million metric tons from SoCalGas; 0.15 million metric tons from SDG&E; and 0.12 million metric tons from our other businesses.

Categorizing greenhouse gas emissions



Greenhouse gas emissions are categorized as follows: scope 1 or direct emissions are emitted by the reporting company; scope 2 and scope 3 emissions are emitted by other companies or customers, as a result of the reporting company's activity.

- **Scope 1 emissions** - Emissions from sources that are owned or controlled by the reporting company. For Sempra Energy, these include emissions from natural gas-fired power plants, natural gas pipelines and fleet vehicles.
- **Scope 2 emissions** - Emissions emitted by another company to generate electricity, heating/cooling or steam that the reporting company purchases and then uses in its own operations. For Sempra Energy, these include emissions from electricity purchased and used in our own facilities, as well as emissions from the electricity purchased for our customers but lost during transmission and distribution.
- **Scope 3 emissions** - Emissions (excluding those already reported in scope 2) that are a result of the reporting company's activity, but occur at sources owned or controlled by others. For Sempra Energy, these include emissions from customer use of our services (such as customers burning natural gas we have delivered); emissions

from the generation of electricity purchased for and delivered to our customers; emissions from the production of natural gas purchased for and delivered to our customers; and emissions from the production and delivery of the raw materials we need for our business (pipes, wires, meters, office supplies). Note that due to the complexity involved in tracking or estimating emissions from some sources, Sempra Energy does not report on all of types of scope 3 emissions.

These descriptions are based on definitions provided in the [World Resources Institute's Greenhouse Gas Protocol](#).



Capturing - and then using - dairy biogas

According to the California Air Resources Board, California's dairies release approximately 19.6 million metric tons of CO₂e into the atmosphere each year. By capturing and conditioning this biogas, then putting it into the natural gas distribution system and delivering it to customers, we can offset a significant amount of greenhouse gas emissions. This also helps California meet its renewable-energy goals, as biogas is considered a renewable resource.

SoCalGas' biogas conditioning service helps customers use biogas produced in their own operations. The company is exploring other ways to increase the supply of biogas in California.

SoCalGas and SDG&E have been focused on measuring, monitoring and reducing methane emissions for many years. All of our operations in the U.S. follow the U.S. Department of Transportation Pipeline and Hazardous Materials Safety Administration (PHMSA) regulations for infrastructure monitoring and testing. To facilitate our compliance with all federal and state regulations, we have implemented or are taking the following actions to help detect and reduce methane emissions:

- We implement best management practices through programs such as the U.S. Environmental Protection Agency's Natural Gas STAR program, of which SoCalGas has been a member for nearly two decades;
- We are proposing to capture bio-methane (renewable gas) from dairies and other sources, and add it to our natural gas distribution system;
- We eliminated all cast-iron pipe from our natural gas distribution system more than 20 years ago;
- We prioritize replacement of pipelines that do not have current corrosion-prevention technologies;
- We capture natural gas during pipeline testing instead of venting it to the atmosphere;
- We conduct leakage surveys using unmanned aerial vehicles (drones), fiber optic cable and point sensors;
- We implement new advanced monitoring technologies and practices in all natural gas storage operations; and
- We are piloting a power-to-gas system that uses surplus renewable energy to drive a chemical reaction known as electrolysis that creates carbon-free hydrogen gas from water. This hydrogen gas can be blended with natural gas to create a lower-emissions fuel source.



Best management practices help our utilities reduce methane emissions.

Helping customers reduce their emissions



The new station strengthens the network of CNG stations across a key regional goods-movement corridor.

In July, SoCalGas opened a compressed natural gas (CNG) station in the heart of a warehouse and distribution district east of Los Angeles.

The new station is open to the public, and strengthens the network of CNG stations across a key regional goods-movement corridor, providing owners and operators of natural gas-fueled trucks and other vehicles with a convenient place to refuel.

Newly available heavy-duty CNG trucks can reduce smog-forming nitrogen oxide emissions 90 percent below California Air Resources Board 2010 emissions standards, and reduce greenhouse gas emissions by 15 percent. This can help improve the quality of life for families in communities near transportation corridors. An expanded network of CNG stations gives companies the confidence to invest in more CNG vehicles.



Interview

Bret Lane, President and Chief Operating Officer of SoCalGas

Editor's note: In October 2015, SoCalGas discovered a leak at one of its injection and withdrawal wells at its Aliso Canyon natural gas storage facility located in the northern part of the San Fernando Valley in Los Angeles County. The leak was sealed in February 2016. For more information, visit alisoupdates.com.

Q: It's been a little over a year since the Aliso Canyon incident. Have you learned what caused the leak?

A: While we know generally that the failure came from the well casing in one of the wells, we do not know the specific cause of the failure. About a month before the well was permanently sealed, the California Department of Conservation's Division of Oil, Gas and Geothermal Resources (DOGGR) and the CPUC hired Blade Energy Partners (Blade) to conduct an independent investigation to determine the root cause of the leak. The timing of the root cause analysis is under the control of Blade, DOGGR and the CPUC.

Q: From a risk management standpoint, what has the company been doing to make sure something like this doesn't happen again?

A: Since the well was sealed, SoCalGas has not stopped working to enhance the infrastructure, technology and safety at Aliso Canyon and our other three storage fields.

At Aliso Canyon, we are conducting comprehensive testing of the wells in two phases involving a battery of six different types of tests, some of which are similar to the testing we do on our pipelines. We test the conditions of the well, including the

integrity of the well's casing. We install and pressure-test brand new steel tubing, which goes inside the casing. (We've installed more than 40 miles of new tubing so far.) And we monitor the pressure on the tubing and the casing from a control room, 24 hours a day, seven days a week.

Going forward, we will withdraw and inject natural gas at the Aliso Canyon storage field through the newly installed inner steel tubing, and only at wells that have passed all tests and have been approved for use by DOGGR. In addition, we are also now operating wells at a reduced pressure, further increasing the margin of safety.

We are also implementing a suite of advanced monitoring technologies and practices that will allow for early detection of leaks at all of our storage fields. These include in-person patrols of every well several times each day; increased training for our employees and contractors; and daily scans of each well with infrared thermal-imaging cameras, which can detect even the tiniest leak by sensing minute temperature differences.

We submitted a risk management plan to DOGGR that includes ongoing physical assessments and monitoring of each well at Aliso Canyon.

Q: Since the leak, SoCalGas has not been allowed to add (inject) natural gas to the Aliso Canyon storage field and yet there have been no major interruptions in service. Is natural gas storage still needed, especially given the growing amount of battery storage in California?

A: The short answer is yes, gas storage is still critical. While we have not been injecting gas, it has sometimes been necessary to use the natural gas already stored in the field. As an example, although this past winter was quite mild, we did have a period of particularly cold weather. During that time, the demand for natural gas was so high that, for several days, we needed to withdraw some of the gas remaining at Aliso to meet natural gas and electric reliability needs in our service territory.

We also take a longer view. As the state of California moves to 33-percent and, ultimately, 50-percent renewable power, we need to be able to continue supplying energy when the sun goes down and solar energy rapidly drops from the electric grid. Quick-starting, efficient natural gas-fired power plants meet these energy needs. And natural gas storage has played - and will continue to play - a vital role in supplying the natural gas needed by

these power plants. Battery storage just hasn't been developed to the point where it will be able to meet that huge demand.

In fact, we're developing our own battery. We are working with the University of California at Irvine to test a "power-to-gas" system which uses excess renewable energy to create hydrogen. We can mix hydrogen, which is carbon-free, into our natural gas pipelines and storage fields to create a lower-emissions fuel source. So in a way, SoCalGas' natural gas infrastructure could be thought of as the world's largest renewable-energy battery.

Q: SoCalGas has made a commitment to fully mitigate the actual natural gas lost from the Aliso Canyon leak. Have you made any progress on this?

A: We remain committed to fully mitigate the emissions impact of the actual natural gas lost during the leak. We're working with various regulatory agencies and are looking at different solutions, including capturing fugitive methane from active waste sources such as dairies and wastewater facilities.

"We need to be able to supply energy when the sun goes down and solar energy rapidly drops from the electric grid."



Northern San Fernando Valley in Los Angeles County, Calif.

Fresh water represents just **one percent** of our total water withdrawal.



The Energía Costa Azul LNG terminal in Baja California, Mexico.

Water

We use billions of gallons of water, primarily to regasify LNG and cool our power plants. We minimize our use of fresh water, particularly in areas where water availability is a concern. Our water policy may be found at sempra.com.

In 2016, Sempra Energy and its businesses withdrew 21.9 billion gallons of water: 19.7 billion gallons of salt/brackish or seawater, primarily used to support LNG operations; 2 billion gallons of reclaimed or recycled water, primarily used to support power generation operations; and 200 million gallons of fresh water, primarily used in employee-occupied facilities and to support our Midstream operations. Fresh water represents just one percent of our total water withdrawal.

We returned 90 percent of the water we withdrew to the source.

We have minimized our need for fresh water in our power generation operations by using dry-cooling technology and reclaimed or recycled water:

- SDG&E's 566-megawatt Palomar Energy Center in Escondido, Calif., uses reclaimed water (treated wastewater) in the electric generation process. This saved 680 million gallons of fresh water in 2016.
- SDG&E's 485-megawatt Desert Star power plant near Boulder City, Nev., uses dry-cooling, which requires only 10 percent of the water used by traditional wet-cooled power plants.
- IEnova's 625-megawatt Termoeléctrica de Mexicali power plant in Mexicali, Mexico, uses treated sewage, cleaned in our own water treatment facility, to cool the plant. As a result, we saved more than 1.3 billion gallons of fresh water in 2016.

Water withdrawal by source (2016)

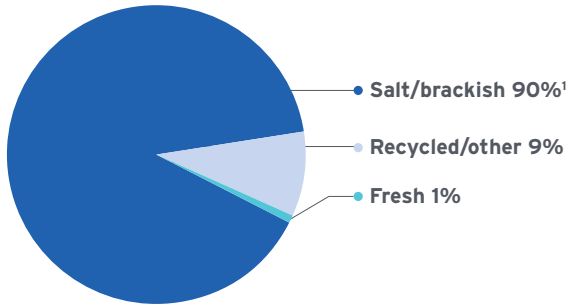

¹ These operations do not have a significant impact on water supplies, because the vast majority of this water is withdrawn from and returned to the ocean.

Water withdrawal by use (2016)¹

Billions of gallons

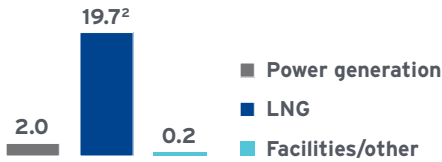

¹ While we continue to improve data collection related to water use, these numbers do not yet account for all aspects of our operations, including natural gas pipeline testing at our California utilities.

² These operations do not have a significant impact on water supplies, because the vast majority of this water is withdrawn from and returned to the ocean.

Xeriscape project cuts water use 60 percent at SoCalGas facility

In August 2016, SoCalGas celebrated the completion of its San Dimas Customer Call Center’s new landscaping project. The utility replaced water-intensive turf with drought-tolerant plants such as agaves, kangaroo paws and red yucca. These colorful shrubs and plants provide a vivid contrast to boulders and a dry stream bed, designed to capture storm water run-off.

As a result of the new xeriscape landscaping, the facility expects to reduce its yearly water usage 60 percent - a savings of 1.6 million gallons of water annually.



Installing drought-tolerant plants can save millions of gallons of water over time.

We are committed to reducing hazardous waste, and expect to see significant reductions over time.

Waste and recycling

At Sempra Energy, we reduce our waste, reuse materials, extend the life of equipment and expand our recycling programs.

In 2016, Sempra Energy and its businesses generated and disposed of 97,585 tons of waste. Our waste and recycling programs diverted nearly 14,350 tons of material from landfills, generating more than \$3.8 million in revenue. Electric transformers, meters and other metals constituted 84 percent of this total by weight.

In 2016, we generated 5,575 tons of hazardous waste and managed and disposed of it according to applicable laws. We are committed to reducing hazardous waste, and expect to see significant reductions over time. The amount of hazardous waste we generate fluctuates from year to year as we complete the clean-up of historic manufactured gas sites, and replace other energy infrastructure.

Sempra Energy businesses encourage customers to switch to paperless billing (e-billing) to reduce the amount of paper we use. As of December 31, 2016, 3.1 million, or 34 percent, of our customers have opted for paperless billing.



Reducing waste and improving efficiency at Sempra Energy headquarters

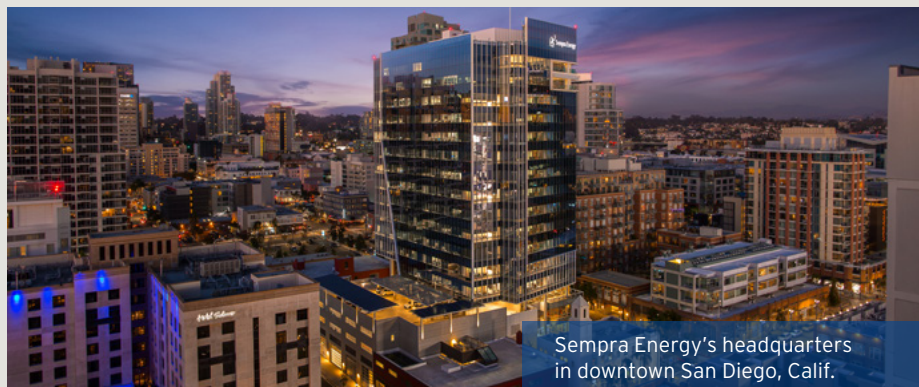

In mid-2015, Sempra Energy moved into a new 16-story headquarters in downtown San Diego. In 2016 we began to realize many of the benefits of the LEED-Gold* structure:

- A 58-percent reduction in electricity use. The building includes a 52-kilowatt solar panel system and abundant natural light.
- A 19-percent reduction in water use. The building was designed for optimal water efficiency, with drought-tolerant landscaping, irrigation efficiency technologies and a bio-filtration system to process storm water.
- A central location, close to public transportation options; dedicated parking for electric vehicles and carpools; and numerous bike-friendly features (the building was certified "bicycle-friendly" by the League of American Bicyclists in 2016).

In addition, employees eliminated more than 200,000 single-use plastic water bottles from the waste stream by using water-bottle refilling stations.

These efficiencies and other operational savings make Sempra Energy's new building cost-neutral, and are a point of pride for headquarters-based employees.

*Leadership in Energy and Environmental Design, or LEED, is a rating system devised by the United States Green Building Council to evaluate the environmental performance of a building.

In 2016, our businesses made **\$53 million** in capital expenditures to comply with environmental laws and regulations.

Environmental compliance

Every Sempra Energy business is accountable for following all applicable environmental regulations and laws, and for obtaining required permits and fulfilling the requirements of such permits. Environmental compliance programs include detailed plans; extensive training and monitoring; and performance evaluation.

In 2016, our businesses made \$53 million in capital expenditures to comply with environmental laws and regulations. This included costs to mitigate or prevent future environmental contamination or extend the life, increase the capacity, or improve the safety or efficiency of existing operations.

In 2016, 97 percent of all agency inspections resulted in no notice of violation (NOV). We received 22 NOVs and paid \$9,012 in fines and penalties, not including settlements. Six of the NOVs were related to operational protocols; five were related to air quality and emissions; five were related to permitting and reporting; four were related to waste; and two were related to water discharge. Compliance personnel at our businesses review, respond to, correct, or, in some cases, challenge the NOVs they receive.

In February 2017, SoCalGas announced that it would pay \$8.5 million as part of a settlement with the South Coast Air Quality Management District to resolve a dispute related to the Aliso Canyon natural gas leak. A description of SoCalGas' response to this incident can be found in our 2015 corporate responsibility report. Additional detail on Aliso Canyon leak-related fines, penalties and settlements may be found in our [2016 10-K](#).

Environmental compliance

	2013	2014	2015	2016
Agency inspections	395	443	563	638 ¹
Internal compliance assessments and audits ²	569	422	422	325
Notices of violation (NOV) ³	8	10	22	22
Percentage of agency inspections with no NOV issued	98	98	96	97
Fines and penalties ⁴	\$1,734	\$1,810	\$50,343	\$9,012

¹ Agency inspections increased after the leak at SoCalGas' Aliso Canyon natural gas storage field.

² 2013 number updated due to a reporting error. The number of internal compliance assessments and audits may vary from year-to-year due to adjustment of inspection cycles as determined by risk assessments.

³ Self-reported violations are not included.

⁴ Does not include settlements. The amount of fines and penalties paid varies from year to year depending on the nature of the violation and the timing of its resolution.

Biodiversity

At Sempra Energy, we are committed to protecting and preserving biodiversity in the areas where we do business, and have restored or protected more than 13,000 acres of land.

We work to meet or exceed laws and regulations related to biodiversity. Our [biodiversity policy](#) articulates how we integrate biodiversity considerations into the planning, construction and operation of energy facilities, balancing the protection of sensitive plant and animal life with our needs as a business. We also work with independent organizations to verify sustainable practices related to land use and biodiversity.

Sempra Renewables' protection of birds and bats provides a good example of how our businesses protect biodiversity.

During project planning, employees identify major biodiversity issues that might have an adverse impact on plant or animal species. They meet with regulatory agencies such as the U.S. Fish & Wildlife Service, Federal Aviation Administration, relevant state agencies and local land use authorities to gain understanding of agency concerns. They initiate field studies (raptor nesting surveys, wetland studies and habitat assessments) and provide input on construction plans, including the need for buffers around areas of concern, such as nests. Project employees also prepare a bird and bat conservation strategy to ensure compliance with federal and state laws and regulations throughout the life of the project. All of these activities take place before construction begins.

During construction, the project group monitors construction activities to ensure protection of biological resources. This includes training construction personnel; minimizing disturbance of critical habitat, roosting areas or wetlands; and ensuring that a biologist or environmental health and safety specialist is present to monitor construction activities, particularly during nighttime work.

During operation, the project group assesses the ongoing impact of the project and makes operational adjustments. Changing conditions, such as new weather patterns, might impact the facility - and might consequently impact plant and animal life. Employees visit the site to help ensure compliance, and stay up-to-date on regulatory changes that might impact the project.

Our other businesses implement similar conservation plans, protecting a wide range of animal species including the desert tortoise, Belding's savanna sparrow, snowy plover, California least tern, light-footed clapper rail, coastal California gnatcatcher, least-Bell's vireo, southwestern willow flycatcher, arroyo toad, Peninsular bighorn sheep and many plant species.

Sempra Energy companies have restored or protected more than **13,000** acres of land.



Construction of the Gasoducto Sonora pipeline in Sonora, Mexico.

Supply chain impacts

Sempra Energy's largest supply chain impacts* are from the natural gas and electricity we procure. Our core business is delivering energy to the approximately 32 million consumers served by our five utilities.

In 2016, of the electricity they delivered, SDG&E purchased 78 percent; Chilquinta Energía purchased 100 percent; and Luz del Sur purchased 95 percent.

Our businesses purchase natural gas through short- or long-term contracts that specify the source of the gas - as well as from supply aggregation points, exchanges and electronic bulletin boards that do not specify the source of the gas. Given the complexity of the natural gas supply chain, Sempra Energy advocates for a consistent set of standards for all natural gas producers.

Thousands of suppliers provide goods and services (beyond electricity and natural gas) to Sempra Energy and its businesses. They provide pipelines and cable to deliver natural gas and electricity; steel and wood for electric towers and poles; meters to measure customer usage; and office supplies and equipment. They also provide tree trimmers, construction workers, security guards, accountants and other professionals.

What impact do our suppliers have on the environment? And how can we encourage them to minimize this impact?

At our California utilities, prospective suppliers bidding on requests for proposals (RFPs) over a specific dollar amount are required to answer sustainability-related questions, and their responses are factored into the decision-making process. We continue to work to find new ways to help suppliers reduce their impact on the environment.

*Supplier selection and monitoring is on [page 21](#), Supplier diversity is on [page 60](#).

Purchased power¹

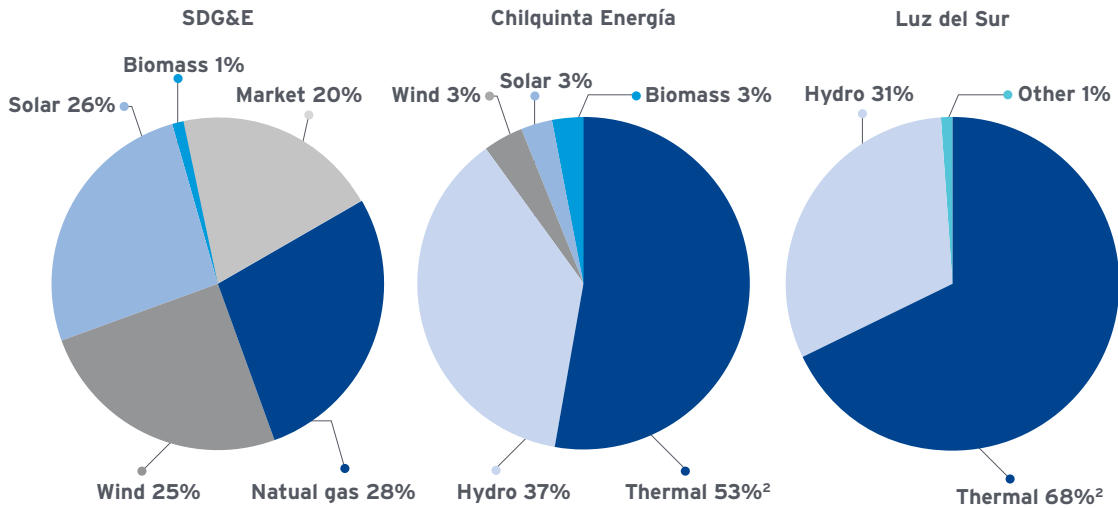

¹ Purchased power does not include power that the utility generated and delivered to its customers.

² Contracts with fuel sources that include natural gas, coal or diesel are collectively referred to as thermal.

Responsible natural gas production

Hydraulic fracturing is the process of using pressurized fluid to fracture rock formations and extract natural gas or oil. The use of hydraulic fracturing has expanded in recent years due to technological advances.

Sempra Energy businesses purchase, store, transport and distribute natural gas. We do not extract, or produce, natural gas in any significant quantities. Nevertheless, we support reasonable rules and regulations to ensure that all natural gas producers are operating to a standard that protects consumers, the environment, the energy industry and our nation’s access to this abundant supply of domestic energy. Our hydraulic fracturing [position statement](#) outlines this view.

Our Responsible Natural Gas Production Working Group is a group of company experts evaluating how Sempra Energy and its businesses can work with key suppliers to minimize the impact of natural gas extraction. We are evaluating existing industry partnerships, voluntary standards and other initiatives to determine how this can inform our practices and purchasing policies.

In addition, SoCalGas is a member of the Natural Gas Collaborative for Responsible Supply, a group of natural gas purchasers interested in promoting the safe and sustainable development of natural gas. The group is working to develop a common set of questions to evaluate and publicly report on the environmental performance of natural gas producers, addressing stakeholder concerns about hydraulic fracturing



We support the safe, sustainable development of natural gas.

Our stakeholders



An employee at the SoCalGas natural gas compressor station in Ventura, Calif.

Employees 46

- Engagement
- Safety
- Employee benefits and wellness
- Diversity and inclusion
- Training and development
- Labor relations

Customers and communities 54

- Engagement
- Human rights
- Public safety
- Energy affordability and customer-assistance programs
- Reliability
- Economic impact
- Philanthropy and community involvement

Business partners and suppliers 60

Regulators 61

Investors and shareholders 61

Employees

Sempra Energy's more than 16,000 employees serve approximately 32 million consumers worldwide. When our employees are trained, challenged and empowered to take initiative, our business thrives.

Engagement

What determines how our employees work; whether they want to stay at Sempra Energy; and whether they recommend our company as a desirable place to work?

Employee engagement is a combination of satisfaction, loyalty and pride. Every other year, our employees are asked to complete a survey to assess their engagement. Employee confidentiality is maintained: The survey is administered by a third party, and results are aggregated, shared and discussed with supervisors who have five or more direct reports. Supervisors with fewer direct reports receive higher-level results.

Employees at all levels from across the company look closely at survey results and take action to make changes or improvements where needed.

Results from the 2015 survey were published in our 2015 report, and indicated strong engagement: Eighty-five percent of respondents stated they "agree" or "strongly agree" with the statement "Overall, I am extremely satisfied with this company as a place to work." Results from 2017 will be published in our 2017 report, to be released in 2018.

Safety

At Sempra Energy, we are not satisfied unless each employee and contractor returns home safely after every workday. We encourage a safety-focused culture in which each individual feels responsible for their own safety as well as the safety of their co-workers.

In 2016, our employee safety performance continued to improve, and we saw decreases in both the rate of recordable injuries and illnesses and the rate of injuries that resulted in time away from work.

The most common employee injuries at Sempra Energy’s businesses are body sprains and strains. We work to minimize these types of injuries through specific training programs on body mechanics and ergonomics. We also focus on safety during pre-work briefings before crews head out to the field. And at safety stand-downs, we review safety lessons learned.

Safety best practices, near misses, alerts and messages are shared within and across our businesses.

Safety performance

	2013	2014	2015	2016
Employee work-related fatalities	1	0	1	0
Employee OSHA recordable injury rate ¹	2.41	2.41	2.35	2.31
Employee lost work time case rate ²	0.88	0.8	0.77	0.73
Contractor work-related fatalities	1	0	1	0
Contractor OSHA recordable injury rate ³	n/a	n/a	n/a	0.8

¹ The number of recordable injuries or illnesses per 100 full-time workers.

² The number of lost time cases per 100 full-time workers.

³ Data from 2013-2015 are not available.

SDG&E launches, expands safety programs

San Diego Gas & Electric launched or expanded several safety programs in 2016.

The utility increased its use of certain types of safety communications, including safety-related e-mails, printed bulletins with safety awareness messages and digital signage. It expanded the Environmental and Safety Compliance Management Program (ESCMP) training to include site managers, with the purpose of supporting the required year-end ESCMP certification of compliance with training and inspections.

SDG&E also tested a fleet telematics program which monitors the location, movement, status and behavior of fleet vehicles. Driver safety remains a critical component of both employee and customer safety at the utility.



SDG&E personnel inspect a pipeline in San Diego County, Calif.

Sempra headquarters designated as a bike-friendly business

The League of American Bicyclists designated Sempra Energy's headquarters building as a bike-friendly business in mid-2016.

A dedicated team of Sempra Energy cyclists worked to develop and implement initiatives that met the League's "5E" requirements for a bike-friendly business: education, encouragement, engineering, enforcement (safe riding) and evaluation.

Building amenities include secure bike racks, a bike repair station and a locker/shower area set aside for cyclists.

Employee benefits and wellness

Sempra Energy offers its employees* a highly competitive compensation and benefits package:

- Market-competitive base pay plan
- Performance-based incentive program
- Flexible benefit program that allows employees to choose the benefits that best meet their needs and the needs of their families, including:
 - Medical, dental and vision insurance;
 - Life insurance, long-term disability, parental leave, long-term care and accidental death & dismemberment insurance;
 - A cash balance pension plan;
 - A 401(k) savings plan with company match;
 - Tuition reimbursement of up to \$5,250 per year;
 - Paid time off including vacation, flex days, holidays and sick leave;
 - An employee assistance program that includes the opportunity for clinical counseling, financial consultation, pre-retirement counseling, child-care consultations, elder-care consultations and legal counseling;
 - Volunteer/giving incentive programs; and
 - A mass-transit/parking subsidy.

Employee wellness improves recruitment, employee retention and performance. We provide a range of resources and programs to help our employees live healthier lives. Programs and amenities vary by location, but are more widely available at facilities with more employees:

- On-site fitness facilities, lockers and showers and subsidized fitness classes encourage employees to incorporate exercise into their workday routine.
- Bicycle-friendly amenities and financial incentives promote the use of biking to work as a healthy, lower-stress alternative to commuting by automobile.

*Sempra Energy businesses offer similar benefits, as detailed on their websites.



Wellness programs help improve employee recruitment and retention.

- When feasible, flexible work schedules, including the option to telecommute, allow for a beneficial balance between work and personal commitments. Backup dependent care provides a safety net for employees experiencing a scheduling conflict with regular childcare or eldercare providers.
- Occasional lunch and learn sessions teach employees about topics such as stress management, heart health and nutrition.
- Ergonomics consultations and free on-site flu vaccinations protect employee health and reduce sick days. Sit-stand desks are available at many locations.

Sempra Energy's wellness, by the numbers* (2016)



*Includes California operations only.

Mentoring Moments

In 2016, the company launched a speed-mentoring program called “Mentoring Moments.” The program, based on a similar national “minute mentoring” program, was championed by Sempra Energy’s Chairman, President and CEO Debra Reed.

At the first “Mentoring Moments” program, employees were divided into small groups. Each group spent 10 minutes with each of the 14 diverse company executives who had volunteered for the program. Employees had the opportunity to access a range of company leaders; get exposure to meaningful advice; and build relationships across the company.

Mentoring can play a critical role in career development. The wisdom gained from such interactions can be instrumental for both personal and professional growth.



Achieving diversity and inclusion in the workplace requires commitment, hard work and effort at every level. More than **300 employees** serve on company diversity and inclusion councils.

Diversity and inclusion

At Sempra Energy, we are a stronger company when we value, respect and include people with different perspectives and diverse backgrounds. A wide range of factors influence and impact every one of our employees, including race, color, national origin, ancestry, ethnicity, education, age, marital status, veteran status, sexual identity and orientation, gender, gender identity or expression, religion, spiritual beliefs, mental and physical capabilities, and life experiences.

By respecting each employee, we create a workplace where unique perspectives yield new ideas – and stronger business performance becomes possible.

Our Discrimination- and Harassment-Free Workplace Policy formalizes our approach. Our executive commitment is a signed statement of our leadership’s belief in the importance of diversity and inclusion. Our chairman, president and CEO is a signatory to a “CEO Action for Diversity and Inclusion” pledge, and has committed that we will welcome different points of view, discuss tough issues and share successes and challenges in our workplace.

Achieving diversity and inclusion in the workplace requires commitment, hard work and effort at every level. More than 300 employees serve on our corporate-wide diversity council or on one of 13 local diversity and inclusion councils. These councils establish priorities and develop employee-focused programs and initiatives. They work to build diversity awareness, celebrate differences and foster an environment of acceptance, respect and inclusion. In 2016, in seminars, meetings (including at Sempra Energy’s annual Diversity and Inclusion Summit) and at lunchtime gatherings, employees discussed a wide range of diversity- and inclusion-related topics including: working across generations; an introduction to LGBT; disability in the workplace; bipolar disorder; gender and gender identity; faith in the workplace; diversity and innovation; diversity and safety; and implicit bias.

Our workforce demographics provide strong evidence of our commitment to, and success with, diversity and inclusion. When job openings occur, we cast a wide net to build a diverse pool of candidates.

U.S. workforce diversity (2016)

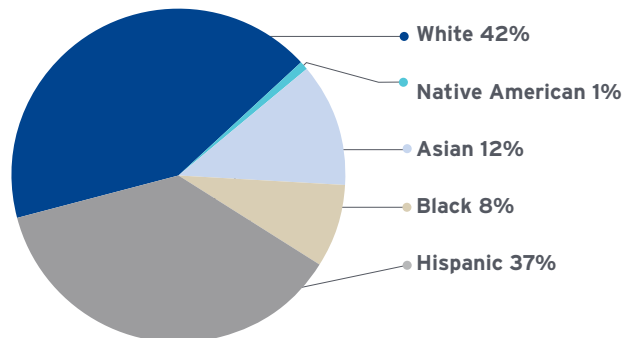

Women in workforce (2016)

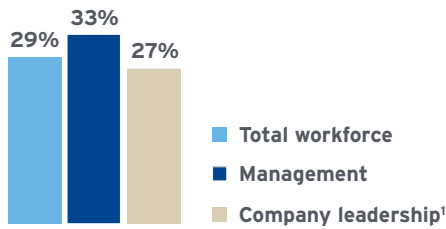

¹Employees in positions that place them in the top 2 percent of the company.

People of color in U.S. workforce (2016)

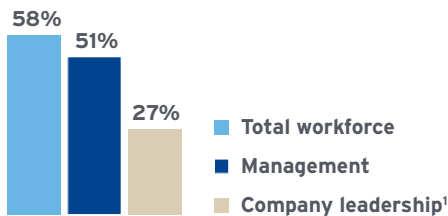

¹Employees in positions that place them in the top 2 percent of the company.

Across the company, women make up 29 percent of the workforce and 33 percent of management. (By comparison, across the utility industry in the U.S., women make up 25 percent of the workforce and 21 percent of management.) Since 2010, the percentage of people of color in our U.S. workforce has increased from 53 percent to 58 percent; the U.S. utility average is 25 percent. Sempra Energy has received several awards for its approach to, and record of achievement on, diversity and inclusion issues.

Training and development

Employee development at Sempra Energy is an employee-driven process utilizing company-provided tools and resources. We encourage each employee to create a career development plan, including both short- and long-term goals, and discuss it with their manager.

MyInfo is an online portal and one-stop shop for any learning or development an employee needs. It includes performance reviews, short- and long-term career goals, required and completed training, compensation, benefits and other information. Using MyInfo, employees may also indicate their career interests and receive notification when matching jobs are posted.

For training, employees may access a menu of online and instructor-led courses that strengthen competencies in areas critical to the company's continued success, as identified in the Sempra Energy Leadership Model. These include leading change, inspiring trust, building talent, acting strategically and exercising good judgment. We also encourage employees to pursue educational opportunities outside of work; our Professional Development Assistance Program provides up to \$5,250 per year to cover the educational expenses of employees working toward a degree or certificate. More than 450 employees participated in this program in 2016.

In 2016, Sempra Energy tested a suite of tools to assess the effectiveness and value of employee training and talent-development programs. Human resources personnel used pre- and post-training surveys to measure changes in quality, productivity, customer satisfaction, employee engagement and costs. Managers participating in the pilot program reported that training was responsible for an improvement of approximately 10 percent in their employees' job performance. The company plans to expand the use of these analytical tools in 2017.

The company also supports mentoring including through its "M-Power" program, a diversity-focused mentoring program designed to help employees set professional goals, work in a diverse workplace, network, transfer knowledge and prepare for career advancement.

Labor relations

Nearly one-half of Sempra Energy's U.S. employees, and 27 percent of its non-U.S. employees, are represented by labor unions. We respect our partnerships with unions and work with them to achieve business results that benefit our employees, our businesses and the communities we serve. We also seek opportunities to collaborate with our unions.

More information on the labor unions representing employees at each of our businesses may be found in our [2016 Annual Report on Form 10-K](#).



Chilquinta Energía was recognized for its excellent safety culture.

Chilquinta Energía recognized for safety culture based on respect and transparency

Sempra Energy utility Chilquinta Energía was recognized in 2016 for its excellent safety culture. The company received the Preventive Management Award from the Carlos Vial Espantoso Foundation and the Chilean Safety Association for its commitment to the health and safety of its employees as demonstrated by a culture focused on accident prevention. The distinction celebrates companies that build labor relations based on respect and transparency.

Chilquinta Energía's safety management is based on a system of inspections, preventive meetings, drills and training via the Center of Applied Technical Competencies (CCTA). All Chilquinta Energía employees and contractors must become certified by the CCTA. As a result of this program, accident rates at the company are well below industry standards.

Collaborating with labor unions on employee safety and health at SoCalGas



A natural gas pipeline inspection. In 2016, employee safety performance continued to improve.

Safety committees discuss operations-related issues and opportunities for improvement.

Working with employees and employee organizations is a critical part of our approach to safety throughout the Sempra Energy family of companies.

At SoCalGas, “safety champions” committees convene at the operating base or regional level and discuss operations-related issues and opportunities for improvement. The companywide Safety Leadership Team is made up of labor union officers and members of safety departments. They discuss topics of concern to the represented employees. The SoCalGas Executive Safety Committee meets quarterly at locations around the service territory with all levels of management and employees to discuss safety issues.

All safety committees have the same objectives:

- To provide continuous focus on employee safety and health as a high priority;
- To empower all employees to take an active role in managing safety;
- To clearly define and then promote (through education and training) each employee’s responsibility and accountability for safe behaviors and work practices;
- To educate all employees about the impacts of unsafe behavior on the individual, family, co-workers and the company;
- To identify company-wide injury and accident trends and recommend best safety practices for implementation;
- To improve the effectiveness of district and department joint safety committees; and
- To form closer alliances with customers about safety hazards employees face in the work environment.

We engage with stakeholders to listen to their concerns and incorporate their suggestions and ideas whenever and wherever feasible.

Customers and communities

Sempra Energy's businesses serve approximately 32 million consumers worldwide. Our businesses operate utilities in California, Mexico, Chile and Peru, meeting the energy needs of a wide range of residential, commercial and industrial customers.

Engagement

Our reputation depends on strong customer and community relationships throughout our operations. Company leaders work with public affairs and community relations personnel to ensure the strength of these relationships.

Our utilities connect with their customers through mail, email, door hangers, advertising, social media and news media. They provide information and answer questions through websites and customer call centers. They review customer research and satisfaction-survey results; host community forums or information sessions; and arrange face-to-face meetings. Information on customer-assistance programs may be found on [page 56](#).

Our infrastructure businesses also engage with people and communities. Project construction provides a good example: Beginning in the early stages of project development, they make sure local residents and business owners have an opportunity to ask questions and make suggestions. As development continues, they keep them informed through face-to-face meetings, community open house events and project update newsletters and other communications. Once development is complete, they continue to engage with stakeholders to ensure community needs are being met.

In addition to these ongoing activities, Community Advisory Councils made up of a cross section of community leaders meet periodically to provide input on topics relevant to a specific business or project.

Human rights

Throughout all of our operations, and across all stakeholder groups, Sempra Energy respects human rights. We engage with stakeholders to listen to their concerns and incorporate their suggestions and ideas whenever and wherever feasible.

Our approach to human rights is specified in several corporate policies, including our [Discrimination and Harassment-Free Workplace policy](#). We are also in the process of developing a human rights policy.

We recently completed a human rights assessment which included benchmarking and an analysis of our operations for areas of potential risk and opportunity. According to the assessment, the siting and operation of certain energy infrastructure projects might have a moderate impact on local communities, property owners and in some cases indigenous peoples. Local, regional and national governments and permitting agencies in the countries where we operate (U.S., Mexico, Chile and Peru) require us to follow specific protocols and to have appropriate public outreach and mitigation plans in place to account for these potential impacts.



Our reputation depends on strong customer relationships throughout our operations.

Public safety

At Sempra Energy, our top priority is safety. Nothing is more important to us than keeping our employees and customers safe.

As of December 31, 2016, our operations span 15 U.S. states, four countries and two continents. We operate five energy utilities, 119,500 miles of natural gas pipeline and 49,881 miles of electric transmission and distribution lines. We also operate two LNG receipt terminals, six underground storage facilities capable of storing 179 billion cubic feet of natural gas, and five natural gas-fired power plants. With our partners, we operate more than 850 wind turbines and nearly 6,800 acres of photovoltaic solar facilities.

Protecting the public from dangerous contact with energy facilities is an important objective and an ongoing challenge - we do not control the actions of third parties which may place them in such contact. In 2016, there were 79 injuries and six fatalities alleged to involve company pipes, poles and wires, construction areas, motor vehicles and other facilities.* Due to pending litigation and the confidential nature of settlements, Sempra Energy cannot provide further information on these incidents.

Our businesses manage the safe operation of their assets, with oversight provided by their own boards of directors, as well as the Environmental, Health, Safety and Technology Committee of Sempra Energy's corporate board of directors. Public safety-related areas of focus include, but are not limited to:

- Educating customers about energy safety: Customers should avoid contact with electric and natural gas equipment, including poles, transformers, pipes and wires. We produce and disseminate safety education materials and encourage customers to "Dial 8-1-1 before you dig," so our U.S. utility personnel can mark the location of buried utility-owned gas pipelines or electric lines free of charge;
- Testing and replacing natural gas pipelines; retrofitting or replacing valves to enable automatic or remote controlled response; and installing new technology for better system monitoring;
- Replacing and upgrading electrical cables, wires and other equipment;

* Does not include incidents alleged to involve the Aliso Canyon leak.

Pipeline testing and methane sensors at SoCalGas

In September 2016, SoCalGas announced the successful test of a system that captures natural gas associated with pipeline testing and replacement - natural gas that previously would have been vented to the atmosphere. The system, now in use, uses a gas compressor to move gas from the pipeline into a mobile compressed natural gas (CNG) storage system, also known as a "tube trailer." SoCalGas has been able to collect or mitigate an average of 85 percent of the gas per testing event.

SoCalGas also completed the successful test of sensors that read methane levels every five minutes near high-pressure pipelines. The prototype module utilized commercially available sensors and sent signals through SoCalGas' advanced meter radio system to communicate with the testing operations center to improve early leak detection. Sensors are now being installed at certain locations around SoCalGas' service territory.

“Stop the job”

At SoCalGas, a safety best practice is “Stop the job.” This means that anyone has the power to stop a job - at any time - if they feel something is not right or if they see a condition that might be unsafe. The job can only be restarted once all concerns have been addressed and safety precautions have been taken.

Employees are encouraged to share and report safety issues because the culture at SoCalGas promotes an approach of continuous learning: Something bad could have happened, how can we learn from it? This focus can be empowering because employees know they can get involved in problem solving in a positive way.

- Installing smart-grid devices to help identify the location of an outage;
- Repositioning electric line underground (where it is not exposed to vehicles, tree branches, Mylar balloons or other potential sources of trouble); and converting power poles from wood to steel, further improving system strength, safety and reliability;
- Engaging in wildfire prevention and preparedness, including vegetation management (tree trimming); extensive weather forecasting; and employee training programs; and
- Assessing and mitigating vulnerabilities related to deliberate cyber or physical attacks on energy infrastructure.

It is vital that our utilities restore natural gas and electric service quickly and safely in the aftermath of a major disaster or emergency. Employees train for such events alongside government officials and first responders. They develop and update contingency plans and emphasize the importance of emergency preparedness to their customers: Uninterrupted access to energy is not guaranteed, so they encourage each customer to develop a written emergency plan and practice implementing it.

Energy affordability and customer-assistance programs

Public agencies, such as the CPUC, make the rules that determine how our utilities may operate, including what rates they may charge. These regulators try to balance the growing needs and demands of utility customers with the utilities' obligation to earn a reasonable rate of return.

Sempra Energy's utility businesses abide by these rules and regulations. They offer programs that help both business and residential customers use less energy: Energy-efficiency retrofits, appliance upgrades and on-bill financing of energy upgrades are a few examples. Level-payment plans help customers smooth out monthly volatility in energy bills. Time-of-use rates, “Reduce your Use” days, and other programs and options provide utility customers with additional money-saving options.

In addition to these customer choices, our California utilities also provide customer-assistance programs to help low-income or medically qualified customers pay their energy bills and/or reduce their energy use. The CPUC establishes enrollment targets for these programs, which include California Alternate Rates for Energy (CARE) ratepayer assistance, the Medical Baseline Allowance program and the Energy Savings Assistance Program (ESAP). Utility performance against these targets is detailed in our “Goals & results” chart on [page 65](#).

Our South American utilities also provide customer assistance. In 2016, Chilquinta Energía made more than 28,000 payment agreements with customers who were having trouble paying their energy bills. Luz del Sur provides a 30- to 40-percent discount for three to six months to approved low-income customers.



Reliability

Our utilities build, operate, maintain and improve their energy infrastructure to provide electricity and natural gas service to their customers. When service interruptions occur, our utilities identify the location or source of the outage and work to restore service quickly and safely. Vehicle crashes, equipment failure and construction activity are some common causes of power outages and natural gas service disruptions.

SDG&E has been recognized for 11 consecutive years with the “Best in the West” award for electric reliability from PA Consulting, an independent consulting firm. A typical SDG&E customer experiences one power outage every other year. On average, an outage lasts about one hour.

Both Chilquinta Energía and Luz del Sur provide service reliability that far exceeds standards established by local regulators. In 2016, for the sixth consecutive year, Chilquinta Energía ranked No. 1 in terms of quality electricity supply among electric distribution utilities in Chile with more than 120,000 customers.

Electric reliability performance (2016)¹

	SAIDI ² : (Average outage duration, in minutes)	SAIFI ³ : (Average number of outages per customer, per year)
SDG&E	72	0.61
Chilquinta Energía	649	3.98
Luz del Sur	540	2.34

¹ System operating conditions and methodology for calculating performance vary significantly from country to country.

² System Average Interruption Duration Index.

³ System Average Interruption Frequency Index.

Reliability is also important to our natural gas utilities. They develop short- and long-term demand forecasts to help ensure that they are prepared to meet the needs of their customers. As an example, SoCalGas delivers natural gas to companies that own and operate natural gas-fired power plants. If SoCalGas does not have an adequate supply of natural gas, these power plants might need to curtail their operations, leading to widespread electricity outages.

Storing energy improves reliability

In March 2016, SDG&E announced that it signed a contract with Hecate Energy Bancroft LLC for a new 20-megawatt energy storage facility. And in August, the utility received regulatory approval to build two energy storage projects with a combined capacity of 37.5 megawatts in San Diego County.

Energy storage improves grid reliability: Batteries charge when there is an abundance of solar or wind power and provide energy in the early evening when demand for electricity peaks.

The CPUC has set energy storage targets for SDG&E: 165 megawatts of energy storage must be operational by 2024; 330 megawatts must be operational by 2030.

SDG&E's Whenergy® shifts energy demand, gives customers options

The CPUC is changing California's electricity pricing to reflect when customers use it. SDG&E calls this Whenergy.

Whenergy prices are based on the time of day and season. By shifting heavy energy use to less costly times, customers can reduce their energy costs while also reducing demand on the electric grid.

Whenergy is already in effect for SDG&E's business customers. The utility plans to roll out Whenergy for residential customers over the next two years.

Economic impact

A company's financial performance matters, not just to its employees and shareholders, but also to its suppliers, contractors, customers and communities it serves, as well as the governmental jurisdictions where it does business. The economic value a company creates is distributed to these stakeholders in the form of wages and benefits; payments for operating costs; dividends to shareholders; payments to governments in the form of fees or taxes; and contributions to community organizations.

In 2016, Sempra Energy generated direct economic value of nearly \$11 billion,* of which \$8.8 billion* was distributed to stakeholders:

Economic value¹

For year ended December 31, 2016
Dollars in millions
Unaudited

Economic value generated

Revenues	\$10,183
Interest and dividend receipts	51
Proceeds from sale of assets and investments	763
	\$10,997

Economic value distributed

Operating costs	\$4,922
Employee wages and benefits	1,971
Shareholders and providers of capital	588
Payments to government	517
Shareholder dividends	749
Community investments	15
	\$8,762
Economic value retained (generated-distributed)	\$2,235

¹ Mobile Gas and Wilmot Gas data are included through the date of sale.

Philanthropy and community involvement

Sempra Energy's philanthropy and employee volunteerism are aligned with our business priorities. We focus on the environment because we recognize that our business operations have an impact. We contribute to community development and education because strong economies support a higher quality of life - and effective schools can develop skilled workers and wise leaders. And we prioritize emergency preparedness to help make sure our communities are ready to respond to unforeseen events.

* These figures were determined according to the guidelines provided by the Global Reporting Initiative.



Employee volunteers from SDG&E work in the City Heights neighborhood of San Diego, Calif.

We contribute to community development and education because strong economies support a higher quality of life - and effective schools can develop skilled workers and wise leaders.

Sempra Energy and Sempra Energy Foundation community giving¹

In millions of dollars

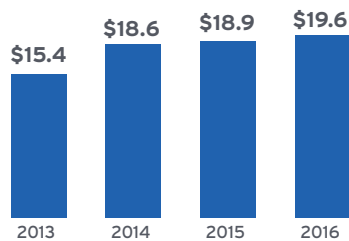

¹Community giving includes charitable giving to fully charitable entities as well as nonprofit civic and community groups.

Examples of community involvement include:

- As part of its Environmental All-Stars program, nearly 100 SDG&E volunteers worked with local residents to repair and renovate nine homes during the annual City Heights Facelift. The team painted, cleaned parkways and planted drought-resistant succulents and trees, helping to improve the neighborhood.
- Employees from the Gas Engineering division at SoCalGas supported the Team Science Summer Science Camp. Employees helped design and teach several science workshops where students applied scientific, technical, engineering and mathematical principals to real-world situations. A contribution from the company also helped provide scholarships for area children to attend the camp.
- The Mesquite Solar Wildlife Oasis is located adjacent to Sempra Renewables' Mesquite Solar complex. A donation from the company, in partnership with the education nonprofit Wildlife for Tomorrow, allowed more than 3,000 K-12 students from the Phoenix area to visit this living lab, where they had the opportunity to learn about the desert habitat and wildlife.
- 150 employees from across the Sempra Energy family of companies biked more than 2,000 miles, gave more than 500 hours of their time and raised more than \$185,000 to fund cancer research in the San Diego area, in collaboration with the nonprofit Pedal the Cause.

In 2016, the company recorded **\$3.3 million** in employee giving and employee volunteer time of **22,000 hours**.

The Sempra Energy Foundation encouraged employees to contribute to relief agencies in the wake of three natural disasters in 2016: the floods in Louisiana, the earthquake in Ecuador and Hurricane Matthew in the Southeastern U.S. The Foundation and employees gave \$140,000 to help people impacted by these events.

Sempra Energy business IEnova's foundation donated school supplies, toys and clothing, and provided financial support to foster homes in Mexicali, Ensenada, Hermosillo, Chihuahua, Torreón, Monterrey and Mexico City.

Sempra Energy supports employee giving through programs like the Sempra Energy Giving Network, a 501(c)(3) nonprofit organization that allows employees to set up direct payroll contributions to charities of their choice. The company also supports employee volunteerism through programs such as the Volunteer Incentive Program, which allows employees who give at least 10 hours of their personal time to a nonprofit organization or school to request a grant from the Sempra Energy Foundation to that nonprofit organization or school.

In 2016, the company recorded \$3.3 million in employee giving and employee volunteer time of 22,000 hours.

Business partners and suppliers

Business partners and suppliers are critical to Sempra Energy's success. We often submit bids in collaboration with business partners who can play an important role in managing or implementing different phases of a project. We depend on suppliers for equipment, parts and services essential to system reliability.

Once a supplier has been selected, supply chain managers in our businesses monitor their performance and work with them to find ways to limit their environmental impact. For a description of how we engage with suppliers, please see the Supplier selection and monitoring section of this report on [page 21](#). For a description of how we manage the environmental impacts of our suppliers and supply chain, please see the Supply chain impacts section of this report on [page 44](#).

At our California utilities, supplier diversity includes working with Diverse Business Enterprises (DBEs). It is important that the companies that provide materials and support to SoCalGas and SDG&E reflect the communities these utilities serve. In 2016, 42 percent* and 43 percent of total spending at SoCalGas and SDG&E, respectively, went to DBEs, far exceeding the guidelines established by the CPUC.

* Excludes highly specialized companies brought in to help stop the Aliso Canyon leak. Including leak-related expenditures, SoCalGas' DBE spend was 35 percent.

Regulators

Sempra Energy's utility customers want safe, clean, reliable and affordable energy. Our utilities want to provide this service, while earning a reasonable rate of return for their efforts. Regulators work to balance these sometimes-competing requirements: Although our utilities may have the exclusive right to provide energy service to their customers, regulators set rules that specify where that energy comes from; how much infrastructure is needed to deliver it; and how much it should cost. Regulators review project proposals, issue permits and oversee utility procurement and delivery of natural gas and electricity.

Regulatory affairs, government affairs and other employees work to ensure regulators understand our company's perspective on a wide range of relevant issues. They participate in public meetings, provide testimony and interact with regulators via phone, email or in-person meetings. Strict rules of conduct govern how we engage with regulators and how these interactions must be reported.

For more information on how our utilities are regulated, please see [page 9](#) of our [2016 Annual Report on Form 10-K](#).

Investors and shareholders

A description of how we engage with shareholders can be found on [page 13](#) of this report, in the Governance section.



Sempra Renewables' Copper Mountain Solar 1 facility in Boulder City, Nev.

About this report



Chilquinta Energía utility trucks head back to base after a full day's work.

Report overview 62

- Reporting framework and materiality
- Data verification and report review

Performance data 64

Goals & results 65

Disclaimers 68

- Forward-looking statements
- Reconciliation of Non-GAAP Measures (Unaudited)

GRI index 71

Content index 85

Report overview

Sustainable Growth is Sempra Energy's corporate responsibility report for the year 2016.

To sustain our growth, we must serve our customers while ensuring we have the raw materials, the public support, the market demand and the skilled employees we will need over the long term.

Reporting framework and materiality

This report has been prepared in accordance with the Global Reporting Initiative (GRI) Standards: Core option. A detailed GRI index can be found on [page 71](#).

Report data includes all businesses and facilities where we have operational control. Additionally, report data includes Cameron LNG, a joint venture that we do not control but that will have a significant impact on our earnings. Data are based on our percent ownership. Report data does not include the Mobile Gas and Willmut Gas utilities; the sale of these facilities was announced in April 2016 and completed in September. Other data exclusions or additions are noted.

Sempra Energy's corporate responsibility report focuses on material issues.

In 2016, we reviewed industry-specific materiality assessments conducted by the Sustainability Accounting Standards Board (SASB) and the Electric Power Research Institute (EPRI) and updated the material issues we address (developed in 2014, based on feedback from approximately 400 stakeholders) as follows:

1. Employee engagement and safety (p. [46-47](#))
2. Ethics and governance (p. [12-16](#))
3. Rates and reliability (p. [56-57](#))
4. Customers and communities (p. [54-56](#), [58-60](#))
5. Compliance (p. [20](#), [42](#))
6. Water (p. [38-39](#))
7. Climate change and emissions (p. [22-35](#))
8. Environmental impact (p. [30-34](#), [38-45](#))
9. The future (p. [4-9](#), [19](#), [22-28](#), [34-35](#), [41](#), [45](#), [46-52](#), [55](#), [57](#), [58](#))
10. Supply chain (p. [21](#), [44-45](#), [60](#))

This report provides detailed descriptions of our approach and performance related to each of these topics.

Please let us know how we can improve our sustainability reporting to better meet your needs.

Contact:

Molly Cartmill
Director, Corporate Social Responsibility
619-696-2000
corporateresponsibility@sempra.com.

Data verification and report review

We use an online system to collect performance data and supporting documentation from our corporate headquarters and principal businesses. We conduct periodic internal audits to review data accuracy. We report some data publicly to government agencies, and obtain third-party verification of a subset of this data in the year following publication.

Greenhouse gas emissions for 2015 were verified as follows: SDG&E, by GHD Services, Inc.; SoCalGas, by Lloyd's Register Quality Assurance, Inc.; and Termoeléctrica de Mexicali, by Cameron-Cole, LLC. The verification process for 2016 greenhouse gas emissions will be completed later in 2017.

The Environmental, Health, Safety and Technology Committee of Sempra Energy's board of directors reviewed this report prior to its publication.

Performance data

	2013	2014	2015	2016
Business and governance				
Revenues (millions of dollars)	10,557	11,035	10,231	10,183
Earnings (millions of dollars)	1,001	1,161	1,349	1,370
Earnings per diluted share (dollars)	4.01	4.63	5.37	5.46
Total assets (millions of dollars)	37,165	39,651	41,150	47,786
Number of board directors	13	13	12	11
Number of independent board directors	12	12	11	10
Independent board directors that are women or minorities (% of independent directors)	50	50	45	50
Ethics and compliance helpline calls	167	202	260	232
Environment				
Renewable energy deliveries (% of previous year total sales) ¹	23.6	31.9	35.2	43
Agency inspections	395	443	563	638 ²
Notices of violation (NOV) ³	8	10	22	22
Inspections with no NOV issued (% of total inspections)	98	98	96	97
Fines and penalties (dollars) ⁴	1,734	1,810	50,343	9,012
Internal compliance assessments and audits ⁵	569	422	422	325
Scope 1 greenhouse gas emissions (million metric tons CO ₂ e)	7.5	6.7	8.1 ^{6,8}	4.7 ⁷
Scope 2 greenhouse gas emissions (million metric tons CO ₂ e)	0.226	0.308	0.250 ⁶	0.212 ⁷
Scope 3 greenhouse gas emissions (million metric tons CO ₂ e) ⁹	56.4	58.9	54.5	52.8
CO ₂ emissions rate for power generation (lbs CO ₂ /megawatt-hour) ¹⁰	708	694	649	561
NO _x emissions from power generation (tons)	464	388	355	235
NO _x emissions rate from power generation (lbs/megawatt-hour) ¹⁰	0.06	0.05	0.05	0.05
SO ₂ emissions from power generation (tons)	21	16	16	8
SO ₂ emissions rate from power generation (lbs/megawatt-hour) ¹⁰	0.003	0.002	0.002	0.002
Total water withdrawal (billions of gallons) ¹¹	31.9	31.4	27.9	21.9
Returned water (billions of gallons) ¹¹	28.7	28.2	25	19.7
Hazardous waste (tons) ¹²	2,901	1,947	5,073	5,575
Our stakeholders				
Number of employees	17,100	17,000	17,400	16,600
Employee work-related fatalities	1	0	1	0
Recordable injury case rate (per 100 full-time workers)	2.41	2.41	2.35	2.31
Employee lost work time case rate (per 100 full-time workers)	0.88	0.80	0.77	0.73
Women in workforce (% of total workforce)	29	29	28	29
Women in management (% of management employees)	33	33	33	33
People of color in workforce (% of U.S. employees)	56	56	57	58
People of color in management (% of U.S. management)	47	48	50	51
Spending with diverse business enterprises (% of total spending) ¹³	45	46	44	43 ¹⁴
Community giving (millions of dollars)	15.4	18.6	18.9	19.6

¹ Power delivered to SDG&E customers only, based on SDG&E's renewable-portfolio-standard reporting, subject to CPUC revision.

² Agency inspections increased after the leak at SoCalGas' Aliso Canyon natural gas storage field.

³ Self-reported violations are not included.

⁴ Does not include settlements. The amount of fines and penalties paid varies from year to year depending on the nature of the violation and the timing of its resolution.

⁵ 2013 number updated due to reporting error. The number of internal compliance assessments and audits may vary from year-to-year due to adjustment of inspection cycles as determined by risk assessments.

⁶ 2015 greenhouse gas emissions data have been updated following an independent verification of the data.

⁷ 2016 greenhouse gas emissions data are undergoing third-party verification and may be updated upon completion of the analysis.

⁸ Includes an estimated 2.1 million metric tons CO₂e equivalent from the Aliso Canyon leak.

⁹ Data includes emissions from power purchased and delivered to SDG&E customers and emissions from our customers' combustion of natural gas. The 2016 number also includes employee air travel.

¹⁰ Emissions rate for power generation on an equity-share basis. Data from Chiliquinta Energía's 8-megawatt peaker plant are not included.

¹¹ While we continue to improve data collection related to water use, these numbers do not yet account for all aspects of our operations, including natural gas pipeline testing at our California utilities.

¹² Hazardous waste generated increased in 2015 in part due to increased remediation activity and pipeline testing. In 2016, an asphalt replacement project also increased hazardous waste numbers.

¹³ Covers spending on diverse business enterprises at SDG&E and SoCalGas only.

¹⁴ Excludes highly specialized companies brought in to help stop the Aliso Canyon leak. Including leak-related expenditures, the utilities' overall DBE spend was 38 percent.

Goals & results¹ ● Met ◐ Partly/in Progress ○ Below target

2016 Goals	2016 Results	2017 Goals
Emissions reduction		
Decrease our CO ₂ emissions rate for power generation by at least 10 percent by 2016 compared to a 2010 baseline.	● Decreased rate by 23 percent	Decrease our CO ₂ emissions rate for power generation by at least 35 percent by 2021 compared to a 2010 baseline.
Renewable energy and innovation		
Provide an average of 25 percent of customers' electricity from renewable sources of energy by 2016 and 33 percent by 2020 (SDG&E)	● Provided 43 percent² from renewable sources of energy	Provide an average of 50 percent of customers' electricity from renewable sources by 2030 (SDG&E)
Invest in 2,028 megawatts of renewable power by 2018 (Sempra Renewables)	● Completed 422 megawatts , bringing the company's wholly and jointly owned operating renewables portfolio up to 2,297 megawatts	Invest in 2,945 megawatts of renewable power by the end of 2021 (68 percent of our generation portfolio) (Sempra Renewables & IEnova)
n/a		Develop or interconnect at least 165 megawatts of energy storage on the system by 2024 and 330 megawatts by 2030 (SDG&E)
n/a		By 2025, develop the charging infrastructure to support 150,000 electric vehicles (SDG&E)
n/a		By 2020, 51 percent of fleet will run on alternative fuels (SoCalGas)
n/a		By 2020, 22 percent of fleet will run on alternative fuels (SDG&E)
Install approximately 6 million natural gas smart meters by end of 2017 (SoCalGas)	◐ 5.8 million meters installed	Install approximately 6 million natural gas smart meters by end of 2017 (SoCalGas)
n/a		By 2030, facilitate the conversion of 160,000 heavy-duty trucks from diesel to natural gas (SoCalGas)
n/a		Decrease carbon in SoCalGas' pipelines by introducing renewable natural gas to the Core natural gas procurement portfolio by 2025
Energy efficiency		
Aim for the following, through customer energy efficiency programs (SDG&E):	Saved:	Aim for additional savings through customer energy efficiency programs (SDG&E):
324 gigawatt-hours in energy savings	● 346 gigawatt-hours	304 gigawatt-hours in energy savings
57 megawatts of demand reduction	● 93 megawatts	50 megawatts of demand reduction
3.2 million therms of natural gas saved	● 3.6 million therms	3.3 million therms of natural gas saved
Aim for the following, through customer energy efficiency programs (SoCalGas):	Saved:	Aim for additional savings through customer energy efficiency programs (SoCalGas):
29.1 million therms of natural gas saved	● 36 million therms	30.3 million therms of natural gas saved
Reduce facility electricity consumption per square foot compared to 2015 usage (SDG&E)	● Reduced consumption 0.4 percent over 2016, a nearly 30 percent reduction from the 2003 baseline	Reduce facility electricity consumption per square foot compared to 2016 usage, while adding infrastructure to charge 300 employee electric vehicles (SDG&E)
Reduce facility electricity consumption 5 percent in 2016 compared 2015 (SoCalGas)	○ Reduced consumption 3 percent	Reduce facility electricity consumption 5 percent in 2017 compared 2016 (SoCalGas)

Goals & results¹ (continued) ● Met ● Partly/in Progress ○ Below target

2016 Goals		2016 Results		2017 Goals
Water				
Reduce facility water consumption compared to 2015 levels and 20 percent less than baseline year of 2010 (SDG&E)	○	Increased consumption 1.8 percent		Reduce consumption compared to 2016 and use 20 percent less than consumed in our baseline year of 2010 (SDG&E)
Reduce facility water consumption 5 percent compared to a 2007 baseline (SoCalGas)	●	Reduced consumption 11 percent		Maintain at least a 5 percent reduction in facility water consumption compared to a 2007 baseline (SoCalGas)
Safety and Public Safety				
Achieve a consolidated recordable injury rate ³ of 2.31 cases per 100 full-time workers	●	Achieved rate of 1.78 cases		Maintain a culture of safety, striving for zero injuries ⁴
n/a				Decrease overall pipeline damage rate (per 1,000 service tickets) by 15 percent compared to a 2016 baseline (SoCalGas & SDG&E)
n/a				Complete enhanced well integrity inspections on 100 percent of underground storage wells by the end of 2019 (SoCalGas)
n/a				Replace approximately 800 miles of pipeline at SoCalGas and 100 miles at SDG&E by 2021 as part of the Pipeline Safety Enhancement Program (PSEP) (SoCalGas & SDG&E)
n/a				Complete high pressure pipeline inspections on 1,700 miles of pipeline at SoCalGas and 120 miles at SDG&E by 2021 as part of the PSEP (SoCalGas & SDG&E)
n/a				Install and retrofit more than 100 automated control valves and test/replace more than 180 miles of high pressure pipeline by 2021 as part of the PSEP (SoCalGas & SDG&E)
Reliability				
Limit average duration of electricity outages (SAIDI) to:				Limit average duration of electricity outages (SAIDI) to:
60 minutes (SDG&E)	○	72 minutes		63 minutes (SDG&E)
553 minutes (Chilquinta Energía)	○	649 minutes		553 minutes (Chilquinta Energía)
643.1 minutes (Luz del Sur)	●	540 minutes		390 minutes (Luz del Sur)
Limit average number of electricity outages (SAIFI) to:				Limit average number of electricity outages (SAIFI) to:
0.51 outages (SDG&E)	○	0.61 outages		0.51 outages (SDG&E)
5.11 outages (Chilquinta Energía)	●	3.98 outages		5.11 outages (Chilquinta Energía)
2.9 outages (Luz del Sur)	●	2.34 outages		3 outages (Luz del Sur)
Customer assistance programs				
Enroll 90 percent of eligible customers in California Alternate Rates for Energy program (SDG&E)	○	Enrolled 77 percent		Enroll 90 percent of eligible customers in the California Alternate Rates for Energy program (SDG&E)
Enroll 90 percent of eligible customers in California Alternate Rates for Energy program (SoCalGas)	○	Enrolled 82 percent		Enroll 90 percent of eligible customers in California Alternate Rates for Energy program (SoCalGas)
Weatherize 20,316 homes through the Energy Savings Assistance Program (SDG&E)	○	Weatherized 19,792 homes		Weatherize 20,316 homes through the Energy Savings Assistance Program (SDG&E)

Goals & results¹ (continued) ● Met ○ Partly/in Progress ○ Below target

2016 Goals

Weatherize **136,836 homes** through the Energy Savings Assistance Program (SoCalGas)

2016 Results

Weatherized **69,811 homes**

2017 Goals

Weatherize **110,000 homes** through the Energy Savings Assistance Program (SoCalGas)

Diverse Business Enterprises (DBEs)

Aim for **40 percent** in spending with diverse business enterprises (DBEs) (SDG&E)



Achieved **43 percent**

Aim for **40 percent** in spending with diverse business enterprises (DBEs) (SDG&E)

Aim for at least **38 percent** in spending with diverse business enterprises (DBEs) (SoCalGas)



Achieved **42 percent**⁵

Aim for at least **38 percent** in spending with diverse business enterprises (DBEs) (SoCalGas)

Community Giving

Contribute **1 percent** of annual pretax income to our communities



Contributed **1.07 percent**

Contribute **1 percent** of annual pretax income to charities⁶

¹ If goal is not Sempra-wide, the relevant business unit is indicated in parentheses in the Goals columns.

² These results subject to review and audit by the CPUC and other regulatory agencies.

³ Goal includes not only employees, but also contractors at our utilities in Mexico, Chile and Peru, where they perform a very substantial proportion of the work.

⁴ Year-to-year safety performance can be found in the Performance data table on [page 64](#).

⁵ Excludes the highly specialized companies brought in to help stop the Aliso Canyon leak. Including leak-related expenditures, SoCalGas' DBE spend was 35 percent.

⁶ Our methodology has changed and going forward our goal will be to give one percent of pretax income to fully charitable entities.

Disclaimers

Forward-looking statements

We make statements in this report that are not historical fact and constitute forward-looking statements within the meaning of the Private Securities Litigation Reform Act of 1995. Forward-looking statements are based upon assumptions with respect to the future, involve risks and uncertainties, and are not guarantees of performance. These forward-looking statements represent our estimates and assumptions only as of the date that this report was first published. We assume no obligation to update or revise any forward-looking statement as a result of new information, future events or other factors.

In this report, when we use words such as “believes,” “expects,” “anticipates,” “plans,” “estimates,” “projects,” “forecasts,” “contemplates,” “assumes,” “depends,” “should,” “could,” “would,” “will,” “confident,” “may,” “can,” “potential,” “possible,” “proposed,” “target,” “pursue,” “outlook,” “maintain,” or similar expressions, or when we discuss our guidance, strategy, plans, goals, opportunities, projections, initiatives, objectives or intentions, we are making forward-looking statements.

Factors, among others, that could cause our actual results and future actions to differ materially from those described in forward-looking statements include actions and the timing of actions, including decisions, new regulations, and issuances of permits and other authorizations by the California Public Utilities Commission, U.S. Department of Energy, California Division of Oil, Gas, and Geothermal Resources, Federal Energy Regulatory Commission, U.S. Environmental Protection Agency, Pipeline and Hazardous Materials Safety Administration, Los Angeles County Department of Public Health, states, cities and counties, and other regulatory and governmental bodies in the United States and other countries in which we operate; the timing and success of business development efforts and construction projects, including risks in obtaining or maintaining permits and other authorizations on a timely basis, risks in completing construction projects on schedule and on budget, and risks in obtaining the consent and participation of partners; the resolution of civil and criminal litigation and regulatory investigations; deviations from regulatory precedent or practice that result in a reallocation of benefits or burdens among shareholders and ratepayers; modifications of settlements; delays in, or disallowance or denial of, regulatory agency authorizations to recover costs in rates from customers (including with respect to regulatory assets associated with the San Onofre Nuclear Generating Station facility and 2007 wildfires) or regulatory agency approval for projects required to enhance safety and reliability; the availability of electric power, natural gas and liquefied natural gas, and natural gas pipeline and storage capacity, including disruptions caused by failures in the transmission grid, moratoriums on the withdrawal or injection of natural gas from or into storage facilities, and equipment failures; changes in energy markets; volatility in commodity prices; moves to reduce or eliminate reliance on natural gas; the impact on the value of our investment in natural gas storage and related assets from low natural gas prices, low volatility of natural gas prices and the inability to procure favorable long-term contracts for storage services; risks posed by actions of third parties who control the operations of our investments, and risks that our partners or counterparties will be unable or unwilling to fulfill their contractual commitments; weather conditions, natural disasters, accidents, equipment failures, computer system outages, explosions, terrorist attacks and other events that disrupt our operations, damage our facilities and systems, cause the release of greenhouse gases, radioactive materials and harmful emissions, cause wildfires and subject us to third-party liability for property damage or personal injuries, fines and penalties, some of which may not be covered by insurance (including costs in excess of applicable policy limits) or may be disputed by insurers; cybersecurity threats to the energy grid, storage and pipeline infrastructure, the information and systems used to operate our businesses and the confidentiality of our proprietary information and the personal information of our customers and employees; capital markets and economic conditions, including the availability of credit and the liquidity of our investments; and fluctuations in inflation, interest and currency exchange rates and our ability to effectively hedge the risk of such fluctuations; changes in the tax code as a result of potential federal tax reform, such as the elimination of the deduction for interest and non-deductibility of all, or a portion of, the cost of imported materials, equipment and commodities; changes in foreign and domestic trade policies and laws, including border tariffs, revisions to favorable international trade agreements, and changes that make our exports less competitive or otherwise restrict our ability to export; the ability to win competitively bid infrastructure projects against a number of strong and aggressive competitors; expropriation of assets by foreign governments and title and other property disputes; the impact on reliability of San Diego Gas & Electric Company’s (SDG&E) electric transmission and distribution system due to increased amount and variability of power supply from renewable energy sources;

the impact on competitive customer rates due to the growth in distributed and local power generation and the corresponding decrease in demand for power delivered through SDG&E's electric transmission and distribution system and from possible departing retail load resulting from customers transferring to Direct Access and Community Choice Aggregation; and other uncertainties, some of which may be difficult to predict and are beyond our control.

We caution you not to rely unduly on any forward-looking statements. You should review and consider carefully the risks, uncertainties and other factors that affect our business as described herein and in our most recent Annual Report on Form 10-K and other reports that we file with the Securities and Exchange Commission.

Reconciliation of Non-GAAP Measures (Unaudited)

Reconciliation of Sempra Energy GAAP Earnings and Diluted Earnings Per Share (EPS) to Sempra Energy Adjusted Earnings and Adjusted Earnings Per Share (Unaudited)

We prepare the consolidated financial statements in conformity with U.S. GAAP. However, management may use earnings and earnings per share adjusted to exclude certain items (adjusted earnings and adjusted earnings per share) internally for financial planning, for analysis of performance and for reporting of results to the Board of Directors. We may also use adjusted earnings and adjusted earnings per share when communicating our financial results and earnings outlook to analysts and investors. Adjusted earnings and adjusted earnings per share are non-GAAP financial measures. Because of the significance and/or nature of the excluded items, management believes that these non-GAAP financial measures provide a meaningful comparison of the performance of Sempra Energy's business operations to prior and future periods.

Non-GAAP financial measures are supplementary information that should be considered in addition to, but not as a substitute for, the information prepared in accordance with U.S. GAAP. The table that follows reconciles adjusted earnings and adjusted earnings per share to Sempra Energy Earnings and Diluted Earnings Per Common Share, which we consider to be the most directly comparable financial measures calculated in accordance with U.S. GAAP, for the years ended December 31, 2016, 2015 and 2014.

Sempra Energy adjusted earnings and adjusted earnings per share

(Dollars in millions, except per share amounts)

	Pretax amount	Income tax expense (benefit)(1)	Non-controlling interests	Earnings	Diluted EPS
Year ended December 31, 2016					
Sempra Energy GAAP Earnings				\$1,370	\$5.46
Excluded items:					
Remeasurement gain in connection with GdC	\$(617)	\$185	\$82	(350)	(1.39)
Gain on sale of EnergySouth	(130)	52	–	(78)	(0.31)
Permanent release of pipeline capacity	206	(83)	–	123	0.49
SDG&E tax repairs adjustments related to 2016 GRC FD	52	(21)	–	31	0.12
SoCalGas tax repairs adjustments related to 2016 GRC FD	83	(34)	–	49	0.19
Impairment of investment in Rockies Express	44	(17)	–	27	0.11
Impairment of TdM assets held for sale	131	(20)	(21)	90	0.36
Deferred income tax expense associated with TdM	–	8	(3)	5	0.02
Sempra Energy Adjusted Earnings				\$1,267	\$5.05
Weighted-average number of shares outstanding, diluted (thousands)					251,155
Year ended December 31, 2015					
Sempra Energy GAAP Earnings				\$1,349	\$5.37
Excluded items:					
Gain on sale of Mesquite Power block 2	\$(61)	\$25	–	(36)	(0.14)
SONGS plant closure adjustment	(26)	11	–	(15)	(0.06)
Sempra Energy Adjusted Earnings				\$1,298	\$5.17
Weighted-average number of shares outstanding, diluted (thousands)					250,923
Year ended December 31, 2014					
Sempra Energy GAAP Earnings				\$1,161	\$4.63
Excluded item:					
SONGS plant closure loss(2)	\$6	\$15	–	21	0.08
Sempra Energy Adjusted Earnings				\$1,182	\$4.71
Weighted-average number of shares outstanding, diluted (thousands)					250,655

¹ Income taxes were calculated based on applicable statutory tax rates, except for adjustments that are solely income tax. Income taxes on the impairment of TdM were calculated based on the applicable statutory tax rate, including translation from historic to current exchange rates.

² After including a \$17 million charge to reduce certain tax regulatory assets attributed to SONGS, the adjustment to loss from plant closure is a \$21 million charge to earnings.

Global Reporting Initiative (GRI) index

Sempra Energy follows the GRI standards, an internationally-recognized standardized framework for disclosing economic, environmental and social performance. The 2016 report qualifies at the in accordance- core level. We also provide information on additional standard disclosures where data is available.

General standard disclosures

Standard number	Description	Response	Omissions
102-1	Name of the organization	Sempra Energy	
102-2	Primary brands, products, and services	Strategy and assets 2016 10K	
102-3	Location of organization's headquarters	San Diego, CA	
102-4	Number and name of countries where the organization has significant operations	We have operations in the United States, Mexico, Chile and Peru (4).	
102-5	Nature of ownership and legal form	Sempra Energy is an investor-owned corporation. Common shares trade on the New York Stock Exchange under the symbol "SRE".	
102-6	Nature of markets served (including geographic breakdown, sectors served, and types of beneficiaries)	Strategy and assets 2016 Annual Report 2016 Statistical Report	
102-7	Scale of the reporting organization (employees, operations, net sales, capitalization, quantity of products/services)	Strategy and assets Performance data 2016 Statistical Report	
102-8	Workforce	Employees Contractors perform a variety of services for our companies. This includes office support services and field support including vegetation management, construction, trenching, etc. In the U.S. approximately 550 of our 13,000 employees work a part-time schedule. Data related to our workforce is compiled through the annual corporate responsibility data collection process. In general human resources information is available in a system called MyInfo which houses a variety of data and information.	Employees by employment type and by gender
102-9	Describe supply chain	Business partners and suppliers Supply chain impacts	Data for diverse supplier spend is currently only available for our California utilities.
102-10	Significant changes from previous report regarding size, structure, and ownership	Year in review 2016 10K In late 2016 we reorganized our businesses into a new structure: Sempra Utilities and Sempra Infrastructure. Sempra Utilities includes SDG&E, SoCalGas, Chilquinta Energia and Luz del Sur. Sempra Infrastructure includes our business in Mexico, IEnova, Sempra LNG & Midstream and Sempra Renewables. Sempra Renewables acquired the 100-megawatt Apple Blossom wind project in Michigan from Geronimo Energy, LLC. In September, IEnova entered into an agreement to purchase the Ventika I and Ventika II wind-generation facilities in Nuevo León, Mexico. Sempra LNG & Midstream sold EnergySouth, the parent company of natural gas utilities Mobile Gas and Willmut Gas, to Spire Inc., formerly known as The Laclede Group, Inc.	

Standard number	Description	Response	Omissions
102-11	Explanation of whether and how the precautionary approach or principle is addressed by the organization	Risk management	
102-12	External charters, principles, initiatives	These are referenced throughout the 2016 Corporate Responsibility Report.	
102-13	Memberships in associations	On sempra.com we publish [http://www.sempra.com/about/governance/political-engagement/] a list of trade organizations and business memberships which received annual dues and payments of \$20,000 or more.	
102-14	Statement from senior decision-maker	Letter from our Chairman, President and CEO	
102-15	Key impacts, risks and opportunities	Risk management The environment Performance data Goals and Results 2016 10k	
102-16	Values, principles, standards and norms of behavior such as code of conduct and code of ethics	Codes of conduct: - Board of directors and senior officers - Employees - Standards for an ethical workplace - Suppliers - Extension of Sempra conduct standards Corporate values	
102-17	Mechanisms for advice and concerns about ethics	Values and code of conduct	
102-18	Governance structure of the organization, including committees under the highest governance body responsible for specific tasks, such as setting strategy or organizational oversight	Governance 2017 Proxy Statement Board Committee Charters The board's Environmental, Health, Safety and Technology Committee assists the board in overseeing the Company's programs and performance related to these matters. The committee also reviews the annual corporate responsibility report prior to its publication and is briefed on related data and content. This committee's focus is consistent with the board's general oversight role of corporate responsibility and stewardship.	
102-20	Identify executive-level position with responsibility for economic, environmental and social topics and reporting to highest governance body.	Dennis Arriola, Executive Vice President - External Affairs and Corporate Strategy, also serves as Sempra Energy's Chief Sustainability Officer. Arriola reports directly to Debra Reed, Chairman and CEO of Sempra Energy.	
102-21	Mechanisms for consultation between stakeholders and highest governance body on economic, environmental and social topics	2017 Proxy Statement	
102-22	Composition of the highest governance body and its committees	2017 Proxy Statement	
102-23	Indicate whether the Chair of the highest governance body is also an executive officer, and if so, reason for this arrangement.	Sempra Energy shareholder proposals have included the request that the company adopt a policy that our chairman of the board be independent and not a current or former executive of the company. Our board of directors believes we are best served by retaining the board's flexibility to determine on a case-by-base basis whether the chief executive officer or an independent director should serve as chairman of the board. In November 2012, our board of directors elected CEO Debra Reed as chairman of the board. During those periods in which our chairman is not independent, an independent lead director is appointed by the independent members of our board. William C. Rusnack has served in this role since 2009. Sempra Energy has established a strong lead director role, consistent with input from shareholders.	

Standard number	Description	Response	Omissions
102-24	Process for determining the qualifications and expertise of the members of the highest governance body for guiding the organization's strategy on economic, environmental, and social topics	Corporate Governance Guidelines	
102-25	Processes in place for the highest governance body to ensure conflicts of interest are avoided	Corporate Governance Guidelines 2017 Proxy Statement	
102-26	Role of highest governance body in setting purpose, values, and strategy	Governance	
102-27	Collective knowledge of highest governance body	Governance	
102-28	Process for evaluating the board's own performance	Corporate Governance Committee Charter	
102-32	Highest governance body's role in sustainability reporting	Governance	
102-35	Remuneration policies for highest governance body and senior executives; Linkage between compensation for members of the highest governance body, senior managers, and executives, and the organization's performance	2017 Proxy Statement	
102-36	Process for determining remuneration	2017 Proxy Statement	
102-37	How stakeholders' views are sought and taken into account regarding remuneration and whether they are independent of management	Governance 2017 Proxy Statement	
102-40	List of stakeholder groups engaged by the organization	Engaging, building trust and fostering relationships with our stakeholders leads to a more stable and predictable business environment. These stakeholders include: our 16,600 employees; the 32 million consumers we serve; the hundreds of communities where we do business; regulators, policymakers and concerned leaders in the jurisdictions where we operate; and our shareholders. Governance Employees Customers and communities About this report	
102-41	Percentage of employees covered by collective bargaining agreements	Labor relations Field employees and some technical, administrative and clerical employees are represented by labor unions in their respective countries. Nearly one-half of Sempra Energy's U.S. employees, and 27 percent of our non-U.S. employees, are represented by labor unions. 2016 10K	
102-42	Basis for identification and selection of stakeholders with whom to engage	Governance Customers and communities About this report	
102-43	Approaches to stakeholder engagement, including frequency of engagement by type and by stakeholder group	Governance Customers and communities About this report	
102-44	Key topics and concerns that have been raised through stakeholder engagement, and how the organization has responded to those key topics and concerns	Governance Customers and communities About this report	

Standard number	Description	Response	Omissions
102-45	Entities included in financial statements, and specify which are included/excluded from this report.	<p>Sempra Energy's principal operating units are:</p> <p>Sempra Utilities</p> <ul style="list-style-type: none"> - SDG&E and SoCalGas, which are separate, reportable segments; - South American Utilities which includes Chilquinta Energía in Chile and Luz del Sur in Peru <p>Sempra Infrastructure</p> <ul style="list-style-type: none"> - Sempra Mexico includes IEnova, one of the largest private energy companies in Mexico - Sempra LNG & Midstream develops liquefied natural gas facilities, midstream natural gas infrastructure and natural gas storage - Sempra Renewables is a leading U.S. developer of renewable energy. Together with its partners, the company owns and operates nearly 2,300 megawatts of renewable energy capacity. <p>Information and data on all operating units is included in this report. Limitations are noted per metric within the Content Index omissions column or as footnotes throughout the report.</p>	
102-46	Process for defining report content and topic boundaries	About this report	Partial response.
102-47	List all material topics identified in the process for defining report content	About this report	
102-48	Explanation of the effect of any re-statements of information provided in earlier reports	2015 greenhouse gas emissions data was updated following an independent review. In addition, we updated the number of internal assessments and audits related to the environment in 2013 upon discovery of a reporting error.	
102-49	Significant changes from previous reporting periods in the scope, boundary, or measurement methods applied in the report	<p>On October 1, 2014, Sempra Natural Gas and its joint venture project partners completed the formation of a joint venture for their investment in the development, construction and operation of a natural gas liquefaction export facility. Our 50.2-percent retained equity in the joint venture, Cameron LNG Holdings, was derived from the contribution of our existing Cameron LNG regasification facility in Hackberry, Louisiana to the joint venture. Given the significance of this project to our future earnings we will report 50.2 percent of the data associated with this facility even though we do not have operational control. 2018 is expected to be the first year of full operations of the liquefaction facility.</p> <p>Report data does not include the Mobile Gas and Willmut Gas utilities; the sale of these facilities was announced in April 2016 and completed in September</p> <p>About this report</p>	
102-50	Reporting Period	Calendar year 2016	
102-51	Date of most recent previous report	June 2016, covering calendar year 2015	
102-52	Reporting cycle	Annual	
102-53	Contact information	Molly Cartmill, Director, Corporate Social Responsibility corporateresponsibility@sempra.com	
102-54	"In accordance" option	About this report	
102-55	Location of GRI Index	GRI Index	
102-56	Assurance	Greenhouse gas emissions for 2015 were verified as follows: SDG&E, by GHD Services, Inc.; SoCalGas, by Lloyd's Register Quality Assurance, Inc.; and Termoeléctrica de Mexicali, by Cameron-Cole, LLC. The verification process for 2016 greenhouse gas emissions will be completed later in 2016. We are working towards assurance for other data in our corporate responsibility report in future years.	

Standard number	Description	Response	Omissions
EU1	Installed capacity, broken down by primary energy source and by regulatory regime	Installed capacity (MW) U.S. Mexico Chile Peru Thermal: 8 Natural Gas: 1,194 625 Wind: 658 329.5 Solar: 732 Hydro: 100	
EU2	Net energy output broken down by primary energy source and by regulatory regime	Energy output (MWh) U.S. Mexico Chile Peru Thermal: 7,022 Natural Gas: 3,678,063 2,697,445 Wind: 1,957,516 211,411 Solar: 994,091 Hydro: 648,527	
EU3	Number of residential, industrial, institutional, and commercial customer accounts	<u>2016 Statistical Report</u>	
EU4	Length of above and underground transmission and distribution lines by regulatory regime	U.S. Chile Peru Above ground (miles): 25,359 10,470 13,957 Underground (miles): 14,432 365 8,187	
EU5	Allocation of CO ₂ e emissions allowances or equivalent, broken down by carbon trading framework	<u>Emissions</u> As part of the effort to meet California's legal requirement that GHG emissions be reduced to 1990 levels by 2020, a cap and trade program was adopted. We participate in the program, which is now linked with Québec's cap and trade system. The first auction of vintage 2013 and 2016 allowances took place in November 2012 and quarterly auctions began in February 2013. Cap and trade compliance began in 2013, with the first compliance period covering electric generators, electricity importers and industrial sources that emit more than 25,000 metric tons of CO ₂ e per year. Phase 2 began in January 2016 and expanded to include distributors of fuels. See https://www.arb.ca.gov/cc/capandtrade/capandtrade.htm for more information.	
103-1	Topic boundaries within the organization	See Appendix	
103-2	Management approach	<u>Strategy and Assets</u> <u>Values and code of conduct</u> <u>Performance data</u> <u>Goals and results</u> Also see references under each material topic.	

Specific standard disclosures

Category: Economic			
Economic performance			
103-2	Management approach	Sempra Energy combines deep industry expertise with rigorous risk management to deliver superior shareholder returns. A company's financial performance matters, not just to its employees and shareholders, but also to its suppliers and contractors; to the customers it serves; and to the communities and governmental jurisdictions where it does business. <u>Year in Review</u> <u>2016 Annual Report</u>	
201-1	Direct economic value generated and distributed, including revenues, operating costs, employee compensation, donations and other community investments, retained earnings, and payments to capital providers and governments	<u>Customers and communities</u>	

Standard number	Description	Response	Omissions
201-2	Financial implications and other risks and opportunities for the organization's activities due to climate change	Risk management Climate change Sempra's response to the CDP's climate change survey also covers this in detail. Please see www.cdp.net 2016 10K	
201-3	Coverage of the organization's defined benefit plan obligations	2016 Annual Report	
201-4	Significant financial assistance received from government	No significant financial assistance was received from any of the governments in countries where we have operations. 2016 Annual Report	
Market presence: This topic did not meet our threshold for materiality			
Indirect economic impacts			
103-2	Management approach	Energy is vital to the communities we serve. We engage with customers and community leaders to identify and discuss potential infrastructure needs and impacts and learn about ways to mitigate them.	
203-1	Development and impact of infrastructure investments and services supported	Customers and communities http://www.semprarenewables.com/our-commitment/community/ http://ienova.com.mx/english/sustainability-community.html	
203-2	Significant indirect economic impacts, including the extent of impacts	Customers and communities http://www.semprarenewables.com/our-commitment/community/ http://ienova.com.mx/english/sustainability-community.html http://sempralng.com/community/	
Procurement practices			
103-2	Management approach	Supply chain impacts Business partners and suppliers	
204-1	Proportion of spending on local suppliers at significant locations of operation	At our California utilities, 66 percent of total supplier spend in 2015 was with suppliers headquartered in California.	Partially reported- only data from California utilities is included.
EU Sector Topic: Availability and Reliability			
EU10	Planned capacity against projected electricity demand over the long term, broken down by energy source and regulatory regime	2016 Annual Report SDG&E Long-Term Procurement Plan	Partially reported- only data from California utilities is included.
EU Sector Topic System efficiency			
EU11	Average generation efficiency of thermal plants by energy source and by regulatory regime	Natural gas U.S. Mexico 7,410 7,292	Partially reported, data from 8-megawatt power plant in Chile is not included.
EU12	Transmission and distribution losses as a percentage of total energy	Transmission losses U.S. Chile Peru Distribution losses 2.04% 1.12% 1.94% 3.06% 7.9% 4.68%	
Anti-corruption			
103-2	Management approach	Code of Business Conduct Values and codes of conduct	
205-1	Total number and percentage of operations assessed for risks related to corruption and the significant risks identified	All business units are analyzed for risks associated with corruption.	

Standard number	Description	Response	Omissions
205-2	Communication and training on anti-corruption policies and procedures	To emphasize the importance of ethics and compliance, we require all employees to complete a training curriculum each year, customized according to their position and responsibilities. The courses address topics such as insider trading; Sarbanes-Oxley regulations; anti-corruption, including local laws and the Foreign Corrupt Practices Act; Federal Energy Regulatory Commission Standards of Conduct; California Public Utilities Commission affiliate-compliance rules; safety; harassment-free workplace' and workplace violence. <u>Governance</u> <u>Risk management</u> <u>Code of Business Conduct</u>	
205-3	Confirmed incidents of corruption and actions taken	No incidents of corruption identified.	
Anti-competitive behavior: <i>This topic did not meet our threshold for materiality, but we are providing some information because of its importance to some stakeholders</i>			
103-2	Management approach	Federal and state antitrust laws were enacted to promote competition, preserve our private enterprise system and protect the public, including companies like Sempra Energy and its subsidiaries, from predatory conduct and unfair competition. It is the long established policy of Sempra Energy and its subsidiaries (the "Companies") to comply with all laws applicable to their conduct and, specifically, with the antitrust laws. Compliance with the antitrust laws can only further the Companies' goals since those laws are intended to protect and preserve a competitive economy in which private enterprise can flourish. <u>Code of Business Conduct</u>	
206-1	Total number of legal actions for anti-competitive behavior, anti-trust, and monopoly practices and their outcomes	There were no legal actions taken for anti-competitive behavior in 2016.	
Category: Environmental			
Materials: <i>This topic did not meet our threshold for materiality</i>			
Energy			
103-2	Management approach	At Sempra Energy, our business strategy is directly linked to our forecast that demand for lower-carbon sources of energy will continue to rise. Our commitment to respecting the environment is aligned with our commitment to delivering shareholder value. We promote energy efficiency; develop and operate lower-carbon energy infrastructure; and embrace innovation because these activities position us to succeed in a low-carbon world and help the environment. <u>Strategy and assets</u> <u>Climate change</u>	
302-1	Energy consumption within the organization	See our response to the CDP climate change survey at www.cdp.net	
302-2	Energy consumption outside of the organization	As an energy utility we work to safely and reliably deliver electricity and natural gas. - Kilowatt-hour sales (millions of hours): 36,810 - Total natural gas throughput (billion cubic feet): 1,004	
302-3	Energy intensity	<u>Emissions</u>	
302-4	Reductions in energy consumption	<u>Goals and results</u>	Only data for electricity reduction at SDG&E and SoCalGas employee-occupied facilities is included.

Standard number	Description	Response	Omissions
Water			
103-2	Management approach	Water Water Policy	
303-1	Total water withdrawal by source	Sempra's response to the CDP's water survey also covers this in detail. Please see www.cdp.net . All numbers in billions of gallons: Surface water: 19.7 Ground water: .41 Rainwater: 0 Waste water: 0 Municipal water: .19	We continue to improve data collection around our water use, but these numbers do not yet account for all of our operations.
303-3	Percentage and total volume of water recycled and reused	Several of our facilities utilize recycled water in their operations. For example, SDG&E's 566-megawatt Palomar Energy Center uses reclaimed water (treated wastewater) to generate electricity and Sempra International's 625-megawatt Termoeléctrica de Mexicali power plant uses treated sewage, cleaned in our own water treatment facility, to cool the plant. Water	Partially reported.
Biodiversity			
103-2	Management approach	Biodiversity Biodiversity Policy	
304-1	Operational sites owned, leased, managed in, or adjacent to, protected areas and areas of high biodiversity value outside protected areas	Biodiversity	Partially reported, not all data available.
304-2	Description of significant impacts of activities, products, and services on biodiversity in protected areas and areas of high biodiversity value outside protected areas	Biodiversity	Partially reported, not all data available.
304-3	Habitats protected or restored	2016 Annual Report SDG&E preservation properties IEnova Sustainability Report	Partially reported, not all data available.
304-4	Number of IUCN Red List species and national conservation list species with habitats in areas affected by operations, by level of extinction risk	<ul style="list-style-type: none"> - <i>Coastal California gnatcatcher</i>: Federal - Threatened; California Department of Fish and Wildlife (CDFW) - Species of Special Concern - <i>Quino checkerspot butterfly</i>: Federal - Endangered - <i>Arroyo toad</i>: Federal - Endangered; CDFW - Species of Special Concern - <i>Least Bell's vireo</i>: Federal and State - Endangered - <i>Southwestern willow flycatcher</i>: Federal and State - Endangered - <i>Barefoot banded gecko</i>: State - Threatened - <i>Peninsular bighorn sheep</i>: Federal and State - Threatened; CDFW - Fully Protected 	Data reported is only for our SDG&E operations.
Emissions			
103-2	Management approach	Climate change Emissions	
305-1	Direct greenhouse gas emissions (Scope 1)	Emissions Sempra's response to the CDP's investor survey also covers this in detail. Please see www.cdp.net .	Emissions from electric utility Luz del Sur are not included.
305-2	Indirect greenhouse gas emissions (Scope 2)	Emissions Sempra's response to the CDP's investor survey also covers this in detail. Please see www.cdp.net .	Emissions from electric utility Luz del Sur and Cameron LNG are not included.

Standard number	Description	Response	Omissions
305-3	Indirect greenhouse gas emissions (Scope 3)	Emissions Sempra's response to the CDP's investor survey also covers this in detail. Please see www.cdp.net .	
305-4	GHG Emissions intensity	Emissions	
305-5	Reduction of greenhouse gas emissions	Emissions	
305-7	NOx, SOx, and other significant air emissions by type	Performance data table	
Effluents and waste			
103-2	Management approach	Waste and recycling Environmental Policy	
306-1	Total water discharge by quality and destination	Water Sempra's response to the CDP's water survey also covers this in detail. Please see www.cdp.net	Partially reported, not all data available, including thermal discharges.
306-2	Total weight of waste by type and disposal method	2016 waste disposal (in short tons) Non-hazardous waste recycled: 9,370 Non-hazardous composted: 56 Non-hazardous waste recovered: 14 Non-hazardous waste incinerated: 8 Non-hazardous waste disposed of through deep well injection: 1,834 Non-hazardous waste disposed of in a landfill: 17,434 Hazardous waste recycled: 704 Hazardous waste composted: 0 Hazardous waste recovered: 29 Hazardous waste incinerated: 191 Hazardous waste disposed of through deep well injection: 0 Hazardous waste disposed of in a landfill: 4,384	
306-3	Total number and volume of significant spills	Sempra Energy did not experience any significant spills in 2016.	
Environmental compliance			
103-2	Management approach	Governance Risk management Environmental compliance	
307-1	Monetary value of significant fines and total number of non-monetary sanctions for non-compliance with environmental laws and regulations	Environmental compliance	
Transport: This topic did not meet our threshold for materiality			
Supplier environmental assessment			
103-2	Management approach	Supply chain impacts Business partners and suppliers Supplier Code of Conduct	
308-1	Percentage of new suppliers that were screened using environmental criteria	At our California utilities, SDG&E and SoCalGas, all new suppliers are screened using environmental criteria.	Partially reported. Other U.S. and international operations are not included in this response, we are working to expand our reporting in this area in future years.
308-2	Significant actual and potential negative environmental impacts in the supply chain and actions taken	We are unaware of any actual or potential negative environmental impacts in our supply chain.	
Environmental grievance mechanisms: This topic did not meet our threshold for materiality			

Standard number	Description	Response	Omissions
Category: Social			
Employment			
103-2	Management approach	Employees	
401-1	Total number and rates of new employee hires and employee turnover by age group, gender and region	Employee turnover: U.S. 13% Voluntary turnover: 6%	Partially reported. While international operations are not included, we are working to expand our reporting in this area in future years.
EU15	Percentage of employees eligible to retire in the next 5 and 10 years broken down by job category and region	Eligible to retire in 5 years: U.S. 36% Eligible to retire in 10 years: 48%	Partially reported. While international operations are not included, we are working to expand our reporting in this area in future years.
EU18	Percentage of contractor and subcontractor employees that have undergone relevant health and safety training	Sempra Energy is committed to the health and safety of its employees, customers, suppliers and the communities in which we operate. Our suppliers are expected to provide a safe working environment that supports accident prevention and minimizes exposure to health risks. It is the supplier's responsibility to know and understand the health and safety laws and regulations impacting the goods and services they provide.	
Labor/Management relations			
103-2	Management approach	Nearly one-half of Sempra Energy employees are represented by labor unions. We value our association with the unions that represent our employees and work collaboratively with them to achieve results that are beneficial to employees, customers and the Sempra Energy family of companies. At Sempra Energy, we are not satisfied unless every employee and contractor returns home safely after every workday. Our culture of personal responsibility is a critical part of safety performance. Our goal is for each employee and contractor to feel personally responsible and empowered to take care of their safety as well as the safety of those around them. Compliance and Management Systems Employees Customers and communities	
402-1	Minimum notice regarding operational changes, including whether it is specified in collective agreements	2016 Annual Report	
Occupational health and safety			
403-1	Workers representation in formal joint management-worker health and safety committees	Safety Labor relations	Percentage of workers represented by committees
403-2	Type of injury and rates of injury, occupational diseases, lost days and absenteeism, and total number of work-related fatalities by region and gender	Employees	
403-4	Health and safety topics in formal agreements	2016 Annual Report	
Training and education			

Standard number	Description	Response	Omissions
103-2	Management approach	Delivering safe, clean, reliable, affordable energy requires significant human capital, creativity and care. When our people are trained, challenged and empowered to take initiative, our business thrives. Employees	
404-1	Average hours of training per year per employee by gender and employee category	Average hours of training and development per FTE in 2016 were 60.	
404-2	Programs for skills management and lifelong learning	Employees	
404-3	Percentage of employees receiving regular performance reviews by gender and employee category	All employees receive regular performance reviews from their manager.	
Diversity and equal opportunity			
103-2	Management approach	Employees	
405-1	Composition of governance bodies and breakdown of employees per employee category according to gender, age, minority group member (other diversity)	Governance Employees	Partially reported.
Sub-category: Human rights			
<i>Non-discrimination: This topic did not meet our threshold for materiality.</i>			
Freedom of association and collective bargaining			
103-2	Management approach	Supplier Code of Conduct	
407-1	Operations and suppliers identified in which the right to exercise freedom of association and collective bargaining may be violated or at significant risk, and measures taken to support these rights	No operations or suppliers identified. 2016 Annual Report Supplier Code of Conduct	
<i>Child labor: Although this topic did not meet our threshold for materiality, we are providing some information because of its importance to some stakeholders.</i>			
103-2	Throughout all of our operations, and across all stakeholder groups, Sempra Energy respects human rights. We recently completed a human rights assessment, which included peer benchmarking as well as an analysis of our worldwide operations for areas of potential risk and opportunity.	Customers and communities	
<i>Forced or compulsory labor: This topic did not meet our threshold for materiality.</i>			
<i>Security practices: This topic did not meet our threshold for materiality</i>			
Rights of indigenous peoples			
103-2	Management approach	Customers and communities	
411-1	Violations of indigenous peoples rights and response and actions taken	No violations have been identified.	
Human rights assessment			
103-2	Management approach	Code of Business Conduct	

Standard number	Description	Response	Omissions
412-1	Percentage and total number of operations that have been subject to human rights reviews and/or impact assessments	<p><u>Human Rights</u></p> <p>Semptra has adopted <u>Business Codes of Conduct</u> that cover human rights, environment, information disclosure, combating bribery, consumer interests, science, and technology, competition, and taxation. We are also currently completing a human rights mapping and assessment project of our operations that will inform future company actions in this area.</p>	

Subcategory: Society

Local communities

103-2	Management approach	<p>Energy is vital to the communities we serve. The infrastructure that delivers this energy includes power poles, substations, service trucks, transformers, valves, meters, pipes and wires. We engage with customers and community leaders to identify and discuss potential infrastructure impacts and learn about ways to mitigate them. Semptra's businesses connect with their customers through mail, email, door hangers, advertising, social media and news media. They host community forums, arrange face-to-face meetings and convene community advisory councils – representative groups of regional leaders who provide input on locally relevant topics. Customer satisfaction surveys provide data that indicate how well Semptra's businesses are serving their customers. With this information, our utilities are able to identify areas where improvement is needed and implement changes to their customer approach, policies and programs.</p> <p><u>Customers and communities</u></p>	
413-1	Percentage of operations with implemented local community engagement, impact assessments, and development programs	<p><u>Customers and communities</u></p> <p>Given the nature of our business, our subsidiaries are deeply engaged and connected with all of the communities we serve.</p>	Partially reported, not all data available.

Supplier social assessment

103-2	Management approach	<p><u>Supplier Code of Conduct</u> <u>Supply chain impacts</u> <u>Business partners and suppliers</u></p>	
414-1	Total and percent of new suppliers and contractors that have undergone human rights screening	All suppliers are expected to comply with Semptra's Supplier Code of Conduct and all applicable employment laws and regulations, including, but not limited to state, federal and applicable in-country laws and regulations regarding: equal employment opportunity; compensation and benefits; child labor; freedom of association; forced or compulsory labor; workplace harassment and discrimination; working hours; paymen	
414-2	Significant actual and potential negative social impacts in the supply chain and actions taken	We are unaware of any actual or potential negative social impacts in our supply chain.	

Public policy

103-2	Management approach	<u>Political involvement</u>	
415-1	Total value of political contributions by country and recipient/boundary	<u>Political contributions</u>	

Sub-category: Product responsibility

Customer health and safety

103-2	Management approach	<u>Customers and communities</u>	
416-1	Percentage of significant product and service categories for which health and safety impacts are assessed for improvement	Semptra Energy's subsidiaries provide gas and electric services to customers. Impacts of both of these products are assessed.	

Standard number	Description	Response	Omissions
416-2	Total number of incidents of non-compliance with regulations and/or voluntary codes concerning health and safety impacts of products and services during their life cycle, by type of outcomes	No incidents identified.	
EU25	Number of injuries and fatalities to the public involving company assets, including legal judgments, settlements and pending legal cases of diseases	<u>Customers and communities</u>	
Marketing and labeling: This topic did not meet our threshold for materiality			
Customer privacy			
103-2	Management approach	Cybersecurity includes the protection of our own operations and activities and the protection of sensitive customer data. The utility industry faces new cybersecurity risks associated with automated metering and smart grid infrastructure. Virtually all SDG&E customers have smart meters. Advanced meter deployment will be completed by 2017 in SoCalGas' service territory. While these new technologies will provide many benefits to customers, including access to their own energy-usage data, both utilities actively monitor, assess and update their systems to avoid cyber breaches. <u>Sempra Energy 2016 10K</u>	
418-1	Total number of substantiated complaints regarding breaches of customer privacy and losses of customer data	No substantiated complaints identified.	
Socioeconomic compliance			
103-2	Management approach	<u>Governance</u> <u>Environmental compliance</u> <u>Code of Business Conduct</u>	
419-1	Monetary value of significant fines and total number of non-monetary sanctions for non-compliance with laws and/or regulations	<u>Environmental compliance</u>	
EU sector topic Access			
EU26	Percentage of population unserved in licensed distribution or service areas	Access to electricity is also an issue in some areas served by our South American utilities, where not everyone is connected to the grid. Peruvian utility Luz del Sur has brought electricity to thousands of Peruvians who live in underprivileged areas through participation in a government program intended to improve economic development and productivity by connecting those communities to electric service.	Partially reported, not all data available.
EU27	Number of residential disconnections for non-payment, broken down by duration of disconnection and by regulatory regime	Number of residential disconnections for non-payment is provided for Sempra's electric and/or natural gas utilities. Chilquinta Energía: 114,457 Ecogas: 3,099 Luz del Sur: 795,325 SDG&E: 40,067 SoCalGas: 129,130	Partially reported, duration of disconnection is not included.
EU28	Power outage frequency	<u>Goals and results</u>	
EU29	Average power outage duration	<u>Goals and results</u>	
EU30	Average plant availability factor by energy source and by regulatory regime	Natural gas: United States 86% Mexico 94%	

Appendix: 103-1

Material issue for Sempra	Corresponding GRI Standards topic	Boundary within Sempra	Boundary outside Sempra
Climate change and emissions	Emissions; Energy; Products and services	All	Customers; Elected officials, community leaders, investors and regulators
Compliance	Environmental compliance; Overall; Biodiversity; Effluents and waste; Public policy; Socioeconomic compliance	All	Customers; Elected officials, community leaders, investors and regulators
Customers and communities	Customer health and safety; Customer privacy; Economic performance; Indirect economic impacts; Rights of indigenous peoples; Human rights assessment; Local communities; Access (EU)	All	Customers; Elected officials, community leaders, investors and regulators
Employee engagement & safety	Occupational health and safety; Labor-management relations; Training and education; Diversity and equal opportunity; Freedom of association and collective bargaining	All	Customers; Elected officials, community leaders, investors and regulators
Environmental impact	Emissions; Energy; Products and services; Water; Biodiversity; Effluents and waste	All	Customers; Elected officials, community leaders, investors and regulators
Ethics and governance	Local communities; Anti-corruption; Customer privacy; Labor/management relations; Diversity and equal opportunity; Non-discrimination; Freedom of association; Indigenous rights; Assessment; Access (EU)	All	Customers; Elected officials, community leaders, investors and regulators
Rates and reliability	Local communities; Access (EU) Availability and reliability (EU); System efficiency (EU)	All utilities	Customers; Elected officials, community leaders, investors and regulators
Supply chain	Procurement practices; Supplier environmental assessment; Supplier social assessment	All	Select external stakeholders
The future	Training and education; Employment	All	Select external stakeholders
Water	Water; Effluents and waste	All	Select external stakeholders

Content index

A

air emissions, 79
 Aliso Canyon, 4, 5, 7, 8, 14, 18, 30, 31, 36, 37, 42, 55, 60, 64, 67, 85
 assets, 9, 11, 55, 58, 70, 71, 77, 83

B

biodiversity, 43, 78
 board of directors, 12, 13, 19, 55, 72

C

carbon emissions. See emissions
 CDP (Carbon Disclosure Project), 7, 76, 77, 78, 79
 CEO letter, 3
 climate change, 22, 23, 24, 28, 29, 76, 77
 emissions reductions, 22, 23, 24, 28, 29, 76, 77
 opportunities, 5, 24, 51, 52, 53, 68, 72, 76
 risks, 22
 U.S. energy policy, 29
 codes of conduct, 76
 community, 25, 54, 58, 59, 75, 76, 82, 84
 community giving, 59
 compliance, 12, 16, 17, 18, 20, 21, 27, 34, 42, 43, 47, 64, 75, 77, 79, 83, 84
 compliance and management systems, 21
 customers, 3, 4, 5, 8, 10, 16, 21, 23, 24, 25, 26, 27, 30, 31, 33, 34, 35, 40, 45, 53, 54, 55, 56, 57, 58, 61, 62, 64, 65, 66, 68, 69, 75, 76, 80, 82, 83
 community engagement, 82
 customer-assistance programs, 54, 56
 philanthropy, 58
 rates, 32, 52, 56, 68, 69, 70, 80
 reliability, 3, 6, 7, 8, 9, 21, 22, 37, 56, 57, 60, 63, 68, 84
 cybersecurity, 12, 18, 68, 83

D

data, 9, 18, 20, 25, 27, 31, 32, 39, 58, 62, 63, 64, 71, 72, 74, 75, 76, 77, 78, 79, 82, 83

E

electric vehicles, 5, 27, 41, 65
 emissions, 3, 14, 20, 22, 23, 24, 25, 26, 27, 28, 30, 31, 32, 33, 34, 35, 37, 42, 63, 64, 65, 68, 74, 75, 78, 79, 84
 biogas, 25, 34
 carbon dioxide equivalent, 26
 climate change, 30
 CO₂e, 25, 26, 30, 32, 34, 64, 75
 emissions rate from power generation, 64
 greenhouse gas emissions, 23, 25, 26, 28, 31, 32, 33, 34, 35, 63, 64, 74, 78, 79
 methane emissions, 14, 32, 34, 36, 37, 55
 scope 1 emissions, 33
 scope 3 emissions, 30, 33
 employees, 3, 5, 7, 9, 10, 17, 19, 20, 24, 36, 41, 43, 46, 48, 49, 50, 51, 52, 53, 55, 56, 58, 59, 60, 61, 62, 64, 67, 68, 71, 73, 75, 77, 80, 81

benefits, 3, 41, 48, 51, 58, 68, 82, 83
 diversity and inclusion, 50, 51
 engagement, 13, 14, 46, 52, 63, 72, 73, 82, 84
 giving, 48, 59, 60, 64
 mentoring, 49, 52
 volunteerism, 58, 60
 wellness, 48, 49
 energy storage, 5, 6, 57, 65
 electric, 4, 5, 6, 7, 8, 10, 18, 24, 25, 27, 28, 29, 31, 37, 38, 40, 41, 44, 55, 56, 57, 58, 65, 68, 69, 75, 78, 82, 83
 natural gas, 4, 5, 6, 7, 8, 10, 14, 18, 23, 25, 26, 27, 28, 29, 30, 31, 32, 33, 34, 35, 36, 37, 39, 42, 44, 45, 46, 53, 55, 56, 57, 61, 64, 65, 68, 71, 74, 77, 83
 environment, 1, 21, 22, 29, 44, 45, 50, 53, 58, 72, 73, 74, 77, 80, 82
 compliance, 12, 16, 17, 18, 20, 21, 27, 34, 42, 43, 47, 64, 75, 77, 79, 83, 84
 emissions, 22
 impact, 19, 23, 24, 29, 31, 37, 39, 43, 44, 45, 50, 54, 58, 60, 62, 63, 68, 69, 76, 82, 84
 training and development, 81
 waste, 37
 water, 23
 ethics, 16, 20, 72, 77

F

fugitive emissions, 32

G

generating capacity, 6, 8, 25, 28
 goals, 8, 14, 31, 34, 51, 52, 68, 77
 governance, 12, 14, 63, 64, 72, 73, 81, 84
 greenhouse gas emissions, 23, 25, 26, 28, 31, 32, 33, 34, 35, 63, 64, 74, 78, 79
 GRI Index, 71, 74

H

health and safety, 12, 21, 43, 52, 80, 82, 83, 84
 human capital, 81
 human rights, 54, 81, 82
 hydraulic fracturing, 45
 hydroelectric, 8, 25, 26, 28

I

innovation, 3, 27, 29, 50, 65, 77

L

labor unions, 52, 53, 73, 80
 LNG, 4, 5, 6, 7, 9, 10, 22, 26, 29, 31, 38, 55, 62, 71, 74, 78

M

materiality, 62, 63, 76, 77, 79, 81, 83
 methane, 14, 26, 27, 31, 32, 34, 37, 55

N

natural gas, 4, 5, 6, 7, 8, 10, 14, 18, 23, 25, 26, 27, 28, 29, 30, 31, 32, 33, 34, 35, 36, 37, 39, 42, 44, 45, 46, 53, 55, 56, 57, 61, 64, 65, 68, 71, 74, 77, 83
 pipelines, 6, 7, 23, 26, 33, 34, 36, 37, 44, 55, 65
 power-to-gas, 8, 34, 37

renewable natural gas, 65
 safety, 26
 storage, 4, 5, 6, 7, 8, 10, 18, 24, 25, 26, 27, 31, 34, 36, 37, 42, 55, 57, 64, 65, 66, 68, 74
 vehicles, 5, 10, 24, 27, 29, 33, 34, 35, 41, 47, 55, 56, 65

P

performance data, 63
 philanthropy, 58
 pipelines, 6, 7, 23, 26, 33, 34, 36, 37, 44, 55, 65
 leak detection, 55
 safety, 7
 political engagement, 72
 contributions, 16, 17, 58, 60, 82
 policies, 12, 16, 17, 20, 21, 29, 45, 54, 68, 73, 77, 82
 position statements, 16

R

recycling, 40, 79
 regulations, 18, 20, 21, 23, 27, 29, 34, 42, 43, 45, 56, 68, 77, 79, 80, 82, 83
 regulators, 4, 10, 24, 31, 56, 57, 61, 73, 84
 reliability, 3, 6, 7, 8, 9, 21, 22, 37, 56, 57, 60, 63, 68, 84
 renewable energy, 9, 10, 22, 23, 25, 26, 29, 32, 34, 37, 68, 74
 risk management, 12, 19, 21, 36, 75

S

safety, 3, 7, 9, 12, 16, 18, 20, 21, 22, 26, 36, 42, 43, 47, 49, 50, 52, 53, 55, 56, 63, 66, 67, 68, 77, 80, 82, 83, 84
 shareholder engagement, 14
 storage, 4, 5, 6, 7, 8, 10, 18, 24, 25, 26, 27, 31, 34, 36, 37, 42, 55, 57, 64, 65, 66, 68, 74
 electricity, 4, 6, 8, 23, 26, 27, 28, 30, 31, 32, 33, 41, 44, 57, 58, 61, 65, 66, 75, 76, 77, 78, 83
 natural gas, 34
 strategy, 10, 43, 68, 72, 73, 77
 supply chain (suppliers), 21, 44, 60, 71, 79, 82
 diverse business enterprises, 64, 67
 impacts, 18, 21, 23, 24, 28, 29, 44, 53, 54, 60, 71, 72, 76, 78, 79, 82, 83, 84
 Supplier selection and monitoring, 21, 44, 60

T

targets, 4, 24, 32, 56, 57

U

utilities, 5, 7, 9, 10, 18, 21, 25, 27, 28, 30, 31, 32, 34, 39, 44, 54, 55, 56, 57, 60, 61, 62, 64, 67, 71, 74, 76, 79, 82, 83, 84

V

values, 10, 14, 15, 16, 20, 21, 72, 73

W

waste, 8, 37, 40, 41, 42, 64, 79, 84
 water, 3, 20, 23, 25, 26, 27, 34, 38, 39, 41, 42, 64, 66, 78, 79
 wind, 2, 6, 8, 23, 25, 28, 55, 57, 71

X

xeriscape, 39



488 8th Avenue | San Diego, California 92101-7123 | sempra.com



**Company Operations Standard
Gas Standard
Gas Operations & System Integrity**

Gas-Handling and Pressure Control	SCG:	184.06
--	-------------	---------------

PURPOSE: To provide guidelines and requirements for gas handling and pressure control operations that involve introducing or interrupting gas flow. This includes the operation of valves, pressure control fittings, and squeeze closures to prevent overpressure of pipelines beyond Maximum Allowable Operating Pressure (MAOP).

1. POLICY AND SCOPE

1.1. This Standard establishes guidelines for written gas handling plans, alternative gas handling plans and various considerations when performing gas handling/pressure control on the gas piping system. Employees are to adhere to these guidelines when performing these duties.

1.2. **Precautions**

1.2.1. Prior to a shut-down, **take precautions** to prevent outage, over and under pressurization caused by unknown obstructions, a rapid increase in load, and/or errors in mapping or planning.

1.2.2. Adhere to all safety concerns and policies.

1.2.3. Utilize temporary EPM (electronic pressure monitor) devices to mitigate over-pressure or under-pressure events as part of the Distribution gas handling procedures.

1.2.3.1. When the project creates a dead-end that is not rated for the available source pressure, a temporary EPM installation is *required* to be part of the gas handling to monitor a terminal point. The temporary EPM shall remain in service until the potential for over-pressurization or under pressurization of the dead-end is eliminated. **See Section 4.1.5.**

2. RESPONSIBILITIES AND QUALIFICATIONS

2.1. Each organization is responsible to designate specific supervisors to be responsible for gas handling operations.

2.2. The following guidelines are intended to indicate the extent this responsibility may be delegated on various types of work:

2.2.1. Written gas handling plans are required for work involving transmission lines, supply lines, medium pressure mains, high pressure services, power-generating plants and any job that is extensive enough for safe handling of gas as determined by the Planner and/or Supervisor. The plans shall be reviewed by the Region Field Operations Manager *and* Gas Control (where applicable) except in an emergency.



**Company Operations Standard
Gas Standard
Gas Operations & System Integrity**

Gas-Handling and Pressure Control	SCG:	184.06
--	-------------	---------------

- 2.2.2. Written Gas Handling plans shall be prepared for other pre-planned projects that require pressure control operations. This includes medium pressure services being tied to the main or tied to another service (as a branch) using any fitting *larger than* a 2-inch steel service tee and/or 2-inch PE SMC fitting.

NOTE: Steel and PE tees installed 'inline' on main to obtain full opening will require Gas Handling regardless of size.

- 2.2.2.1. The Distribution Gas Handling Instructions are provided separately in Word format and are used in conjunction with the gas handling locations depicted on the construction sketch. See [Standard 192.0010](#), *Preparation of Construction Sketches*, and **Appendix A** of this document.
- 2.2.2.2. As a part of the project package pre-construction routing for reviews, the Planner creates and finalizes a Planner's Sketch and preliminary Gas Handling plan. These items along with any pertinent project contents are routed to the following for review, signatures, corrections and/or recommendations. See [Standard 184.0016](#), *Main Construction Project Routing*.
- The Lead Planning Associate (LPA) (if applicable)
 - Planner's Supervisor
 - Field Supervisor
 - Area Manager (if applicable)
 - M&R department (if applicable)
 - Engineering (if applicable)
 - CP
- 2.2.2.3. Post-construction, the responsible supervisor will sign and date the Distribution Gas Handling Instructions to verify the operations were performed as planned.
- 2.2.2.3.1. If the performance of the actual gas handling operations varies significantly from the Distribution Gas Handling Instructions, the responsible supervisor will amend the document in Word and print, sign, and attach the revised Gas Handling Instructions to the original copy and return them in the project package.



**Company Operations Standard
Gas Standard
Gas Operations & System Integrity**

Gas-Handling and Pressure Control	SCG:	184.06
--	-------------	---------------

- 2.2.3. An alternative gas handling plan shall be included with a package (12 inch or larger pipe, or 60 psig and greater), in case of the inability to achieve a "no gas flow" shut-in (potential bypassing valves or line stoppers). The alternative gas handling plan shall be written as a "Cold" or "Hot" tie procedure.
- 2.2.3.1. The sequence of activities in the gas handling plan shall be prioritized. Equipment to monitor and control the pressure shall be installed and operational prior to the system being pressurized and remain in place as long as the system is pressurized.
- 2.2.3.2. The gas handling plan shall require that the work site be left in a safe condition, and any out of service pipe or equipment be closed to gas flow and protected from accidental overpressure due to valve leak-by or other unexpected condition.
- 2.2.3.3. When any work is performed on, or which results in, an isolated pipeline section of 1000 feet or less being served by an active regulator station(s), valve and squeezing operations (both closure and opening) should be executed slowly (over a period of no less than one minute) in order to allow for transient conditions to be dampened, to avoid over-pressuring a short section of pipeline. This is particularly important where the upstream regulator station is served by pilot-operated gas regulators. Pipeline pressure should be noted and recorded after each of these operations.

Note: Although work plans and gas handling plans may support information conducive to a successful shutdown, it is the responsibility of the field supervisor to verify information is accurate before/after making a shutdown.

- 2.2.4. Supervision ensures that safety and gas system integrity are maintained during the Gas Handling Operation. Supervision reviews the Gas Handling Procedure with the crew before the start of the job. In addition, all Main/Line stop operations are performed under the direction of the responsible supervisor.
- 2.2.5. Review gas-handling procedures with the crew(s) performing the job operations mentioning key elements such as, but not limited to:
- Timeline of events
 - Maximum and minimum pressures
 - Operation sequence
 - Each member's responsibilities
 - Items of safety concerns



**Company Operations Standard
Gas Standard
Gas Operations & System Integrity**

Gas-Handling and Pressure Control	SCG:	184.06
--	-------------	---------------

- 2.2.6. When work is performed by a contractor, the supervisor responsible for the gas handling operations confirms that the contractor understands the requirements concerning the installation of pressure gauges, bypass connections, etc., as well as the purging and gas handling plans. Designated Company representative observes, directs or assists the contractor in conducting the gas handling and purging operations as needed.
- 2.2.7. Bypass district regulator stations shall be performed only under the direction of a qualified employee (such as a Meter and Regulation Technician #1). Gauges showing the district pressure are observed continuously while bypassing stations.

3. DEFINITIONS

- 3.1. **Blow-down** – Reduce line pressure by venting.
- 3.2. **Blow-down stack** – A vertical metallic pipe through which air or gas is vented.
- 3.3. **Dead-End** – An isolated pipeline segment that is downstream of a regulator station, valve or pressure control fitting and serves no customer gas demand.
- 3.4. **EPM** (Electronic Pressure Monitor) - a microprocessor-based, stand-alone, self-powered data recorder that measures gas pressure, gas temperature, case temperature, and internal battery voltages.
- 3.5. **Pressure gauge** – Instrument used to measure pressure.
- 3.6. **SMC** – Service to Main Connection.

<p>Note: Install pressure gauges upstream and downstream of the portion of main to be shut-down. Pressure gauge stack is not used as a blow-down stack.</p>
--

4. PROCEDURE

- 4.1. **Shut-Down of Supply, Feeder, or Distribution-Operated Transmission Lines**
- 4.1.1. Follow this procedure when supply lines, feeder lines, or transmission lines are shut down.
- 4.1.2. A detailed written procedure shall be prepared for each shutdown that involves gas handling or fire control work. Exception: emergency situations.



**Company Operations Standard
Gas Standard
Gas Operations & System Integrity**

Gas-Handling and Pressure Control	SCG:	184.06
--	-------------	---------------

4.1.2.1. The sequence of activities in the gas handling plan shall be prioritized. Equipment to monitor and control the pressure shall be installed and operational prior to the system being pressurized and remain in place as long as the system is pressurized.

4.1.2.2. The gas handling plan shall require that the work site be left in a safe condition, and any out of service pipe or equipment be closed to gas flow and protected from accidental overpressure due to valve leak-by or other unexpected condition.

4.1.3. Review plans with Gas Control, where applicable and pursuant to [GS CRMP6](#), *Gas Control Management of Change*, and [GS 223.0145](#), *Planning Shutdowns for Transmission and Storage*, when conducting transmission system shutdowns.

4.1.4. Efforts to limit inconvenience to the general public and governmental agencies shall be made as practical, without jeopardizing any items pertaining to safety. Such agencies may include:

- Air Pollution Control Districts
- Police Departments
- Fire Departments
- Civil Aeronautics Board
- Airfields
- Highway or Street Departments

4.1.4.1. Notify the appropriate agencies of any planned blow-down or release of gas to the atmosphere and coordinate the work with their activities as necessary. See [GS 180.0085](#), *Valve Usage and Selection Guide* for location of blow-down valves.

4.1.4.1.4.1.4.2. Any project that requires gas blown to atmosphere will build time into the project schedule to reduce methane consistent with safe operations and consider alternative potential sources of supply to reliably serve customers and maintain feasibility. Operating pressure should be reduced to the lowest operationally feasible level in order to minimize methane emissions before non-emergency venting of high-pressure distribution (above 60 psig), transmission and underground storage infrastructure consistent with safe operations and whenever practicable, work should be bundled to prevent multiple venting of the same piping.

Formatted: Font color: Red

Formatted: Font color: Red



**Company Operations Standard
Gas Standard
Gas Operations & System Integrity**

Gas-Handling and Pressure Control	SCG:	184.06
--	-------------	---------------

~~4.1.4.2~~~~4.1.4.3~~. If possible, notify the public immediately adjacent to a blow-down site at least one day in advance of blow-down to avoid public concern about noise or odor.

~~4.1.4.3~~~~4.1.4.4~~. Notify the Customer Services Department serving the affected area and arrange for customer notification in shutdowns that will curtail service. Commercial and Industrial meter accounts are notified of impact and or curtailment by means of the RER (Request for Engineering Review) and the various personnel working in the C/I Services group.

~~4.1.4.4~~~~4.1.4.5~~. Notify Customer Call Center, informing them of the areas that may be impacted.

Note: A minimum of 3 days notification to hospitals and schools (within 500') is required before starting non-emergency construction. See [GS 184.011](#), *Notification of Excavation and Construction Activities - Assembly Bill Number 1937/ PUC Code 955.5*

4.1.5. Action Required:

4.1.5.1. When closing any valve or conducting operations that produces a 'Dead-End' pipeline exiting a regulator station and the isolated pipe is not rated for the full-inlet pressure of the regulator station:

4.1.5.1.1. Install pressure monitoring equipment and monitor the pressure both upstream and downstream of any valve or regulator subject to manual operation or for any bypass operation.

4.1.5.1.1.1. If this requires the installation of gauges, make every effort to find a suitable location to install such in the area in which you are working. If this is not practical, employ personnel and/or gauges at locations in the nearest vicinity of your work location where pressures indicative of the pressure on each side of your valve can be monitored.

4.1.5.1.1.2. For work which holds the potential to affect a Distribution pressure district or supply line operation, use of EPM devices (either permanent or temporary) **will be** employed in coordination with Distribution Region Engineering.



**Company Operations Standard
Gas Standard
Gas Operations & System Integrity**

Gas-Handling and Pressure Control	SCG:	184.06
--	-------------	---------------

- 4.1.5.1.1.3. Where possible, monitor pressures for no less than 15 minutes on each side of a valve after conducting such work, to ensure no system upset or destabilization has occurred.
- 4.1.5.1.1.4. Similar pressure monitoring and work coordination should be made with Gas Control pursuant to [GS CRMP6, Gas Control Management of Change](#), and [GS 223.0145, Planning Shutdowns for Transmission and Storage](#) when conducting transmission system shutdowns.
- 4.1.5.1.2. Close the inlet valves to the regulator run(s) in the station prior to downstream valve closure or pinching operation. The handling of regulator station facilities shall be performed only under the direction of a qualified employee (such as a Meter and Regulation Technician #1).
- 4.1.5.1.3. Monitor isolation section pressure for no less than 15 minutes after all valves are closed to ensure a secure shut-in.
- 4.1.5.2. Plan for Equipment Malfunctions.
- 4.1.5.2.1. Be aware that while our system is designed with the highest quality components and redundant safety systems, sometimes equipment operates imperfectly or is otherwise compromised. This potential should be considered in your work plans and execution.
- 4.1.5.2.1.1. Have a backup plan if a valve or regulator does not seal completely or other piece of equipment fails, and be aware of anything that looks out of the ordinary.
- 4.1.5.3. If unsure about a specific operation, plan or Gas Standard, seek guidance from your immediate supervisor or management team.
- 4.1.5.4. Know and understand the piping system you are working on, and the implications of valve operation on upstream and downstream pressures on each relevant pipeline section before beginning work.



**Company Operations Standard
Gas Standard
Gas Operations & System Integrity**

Gas-Handling and Pressure Control	SCG:	184.06
--	-------------	---------------

4.2. Transmission Line Shut-Downs

- 4.2.1. Determine the effect of the Transmission Line shut-down on the distribution system and make plans for necessary distribution operations:
- Make test shut-downs of distribution facilities when necessary to determine the effect of the transmission shut-down on distribution pressures.
 - Assist the responsible supervisor, if required, in conducting shutdowns of transmission facilities for the same purpose.
 - Evaluate remedial measures (providing temporary facilities, more favorable shut-down schedule, etc.) when adverse effects are found.
- 4.2.1.1. Review the proposed transmission shutdown plan. When conflicts are encountered, work out a mutually satisfactory alternate schedule or arrangement with the responsible supervisor.
- 4.2.1.2. Make every effort to assist the responsible supervisor in reducing line pack prior to blow-down in order to minimize the amount of gas blown to atmosphere.
- 4.2.1.3. Plan and arrange for other distribution work that can be performed in conjunction with the shut-down provided the shut-down time is not unduly extended.
- 4.2.1.4. Make arrangements for alternate supply and/or notification to customers affected by the shutdown.
- 4.2.1.5. Isolate distribution facilities from the transmission facilities being shut down. Perform other distribution work as planned only after confirmation of the shutdown is obtained from the responsible supervisor.
- 4.2.1.6. Observe progress of the transmission job, as necessary, to maintain operating control of the distribution system.
- 4.2.1.7. Return the distribution system to normal operation after notification from responsible supervisor.

4.3. Valve Verification

- 4.3.1. Prior to beginning a gas handling procedure, a physical inspection of all affected valves shall be conducted to verify the valve type and position match written gas handling plans, in addition to confirmation of the valves being operable. See [GS 184.16](#), *Valve Inspection and Maintenance* –



**Company Operations Standard
Gas Standard
Gas Operations & System Integrity**

Gas-Handling and Pressure Control	SCG:	184.06
--	-------------	---------------

Distribution. If the physical inspection reveals the valve type or position does not match the written gas handling plans, do not move forward with work until consulting with Engineering to determine the impact and to correct the written gas handling plans.

4.4. Pressure Gauge and Bypass Installations

- 4.4.1. Pressure gauges are to be of a range that will allow the observer to detect minor changes in pressure. For example, use a 0-15 psi gauge when the operating pressure is 10 psig rather than using a 0-60 psi gauge. Prior to use, validate that gauges are accurate and in satisfactory working condition.
- 4.4.2. Where two or more pressurized pipelines are being connected, the pressure in each pipeline being connected must be determined prior to allowing gas to flow between the pipelines. Utilize pressure gauges and bypasses in distribution facilities shut down as follows.
- 4.4.3. Two-Way Feed:
- 4.4.3.1. Where a two-way feed is indicated, verification is required. Install pressure gauges on each side of the portion of the main to be shut-down whether or not a bypass is used.
- 4.4.3.2. The squeeze method of closing off a steel main does not allow it to be reopened immediately or throttled. Install an adequate bypass and gauges around the first squeeze, or the section to be squeezed, to prevent an accidental outage where a two-way feed is indicated but which may not exist.
- 4.4.3.3. The designated supervisor specifies the type and size of the bypass based on pressure and load conditions. When requested, Planning will size the bypass. When working with Distribution facilities, Region Engineering will confirm Planning's bypass recommendation.
- 4.4.3.4. The bypass requirement does not apply when a squeeze is used in combination with a valve or pressure control fitting when the valve or pressure control fitting is used first to stop the flow of gas through the main and the two-way feed is verified.
- 4.4.3.5. On plastic pipe the squeeze method permits immediate reopening; therefore, a bypass may not be necessary.



**Company Operations Standard
Gas Standard
Gas Operations & System Integrity**

Gas-Handling and Pressure Control	SCG:	184.06
--	-------------	---------------

4.4.4. One-Way Feed:

4.4.4.1. Where a one-way feed is indicated, and a bypass is used, install pressure gauges upstream and downstream of the portion of main to be shut-down.

4.4.4.2. Where a one-way feed is indicated, and service is not to be maintained downstream of the shut-down, install a pressure gauge on the upstream and downstream side of the closure to verify one-way feed is accurate.

4.4.4.3. Pressure Gauge Locations:

4.4.4.3.1. Install pressure gauges on existing service connections or pressure taps where they can be properly manned for pressure observation and immediate communication with the responsible supervisor in charge of the shut-down.

4.4.4.3.2. If there are no convenient service connections or pressure taps on the main, make mainline taps adjacent to the closure device for installing pressure gauges. Do not install pressure gauges on blow-down stacks, bypass, or bypass fittings.

4.5. **Pressure Observations**

4.5.1. Artificial Load

4.5.1.1. Install a blow-down stack, or use an adjacent service and create an artificial load, to make certain that facilities to remain in service are adequately supplied. Reduce the main pressure two or more times by means of the stack. Determine that the main pressure returns to district pressure each time the stack is closed after blowing.

4.5.2. Blow-down Stack

4.5.2.1. The blow-down stack and related fittings must be of sufficient size to create a flow in the system which is large enough to verify that an adequate supply exists to serve the area being isolated.

4.5.3. Observe gauges to check the effects of operating valves, fittings, or squeeze closures.

4.5.3.1. When a valve or pressure control fitting is used or a squeeze is made in plastic pipe, close it slowly so that any change in pressure may be observed before the main is completely shut-down.



**Company Operations Standard
Gas Standard
Gas Operations & System Integrity**

Gas-Handling and Pressure Control	SCG:	184.06
--	-------------	---------------

4.5.3.2. After closure, observe the pressure for a sufficient amount of time to verify pressure has stabilized before proceeding with any piping changes.

4.5.3.3. If the pressure does not hold as planned, reposition the valve or stopper immediately to restore supply unless the pressure has dropped too low to maintain adequate pressure on customers' facilities.

4.5.3.3.1. If the pressure has dropped too low, leave closed and handle as an outage. Do not re-pressure until all affected customers have been shut-off at the meter.

4.6. Temporary Gas Supply

4.6.1. If you have a need for portable Gas Pods and/or for portable manifolds (Christmas tree) please contact.

4.6.1.1. During regular working hours 6:00 AM – 2:30 PM, Monday – Friday.

- For Gas Pods: Call the Shipping Dispatcher at (562) 806-4222.
- For manifolds (Christmas tree): Call the Natural Gas Vehicles Group at (562) 806-4309.

4.6.1.2. During off hours

- The Logistics On-Call Supervisor through the Message Center at (213)-244-8900 during off-hours.

5. OPERATOR QUALIFICATION COVERED TASKS
(See [STANDARD 167.0100](#), *Operator Qualification Program, Appendix A, Covered Task List*)

Not Applicable

6. RECORDS

Not Applicable

7. APPENDIX

Appendix A

Distribution Gas Handling Instructions (*See next page*)



**Company Operations Standard
Gas Standard
Gas Operations & System Integrity**

Gas-Handling and Pressure Control	SCG:	184.06
--	-------------	---------------



Gas Handling Instructions
*Standard 184.06 Gas Handling and Pressure Control
Standard 184.0350 Pressure Control - General*

Click here to enter text.

Notification No. Click here to enter text.

Work Order No. Click here to enter text.

Pre-Construction Review/Approval		Construction Approval/ Verification	
SIGN	DATE	SIGN	DATE
<small>(PRINT NAME BELOW LINE)</small>		<small>(PRINT NAME BELOW LINE)</small>	
LPA		FTL OR FOSH	
TSS		NOTE: If Gas Handling changed from the Pre-Construction plan, modify the document to suit in Word, print - sign - date the revised document and attach it to the original instructions and return it with the project package. Check the box below if instructions are revised.	
		<input type="checkbox"/> Revised Gas Handling Instructions	
FTL OR FOSH			

NOTE: Install a test fitting or utilize a suitable existing fitting to verify system pressure is 35 PSIG.

1.

Double click the icon below to save a copy of the Distribution Gas Handling Instructions template.



Gas Handling
Template Distribution. <% Gas Handling Template Distribution%>



**Company Operations Standard
Gas Standard
Gas Operations & System Integrity**

Gas-Handling and Pressure Control	SCG:	184.06
--	-------------	---------------

NOTE: Do not alter or add any content from this page down; the following content is automatically generated.

Brief: Added in Section 2.2.1.–Now requires gas-handling for any job that is extensive enough for safe handling of gas as determined by the Planner and/or Supervisor.’ Added in Section 2.2.2.–Now requires gas-handling for medium pressure services being tied to the main or tied to another service (as a branch) using any fitting larger than a 2-inch steel service tee and/or 2-inch PE SMC fitting.
Added ‘Note’ after Section 2.2.2.–Now requires gas-handling for steel and PE tees installed ‘inline’ on main, regardless of size, to obtain full opening. Modified routing in Section 2.2.2.2 to match guidelines in 184.0016, Main Construction Project Routing. Added Section 3.6 defining SMC.

Document Profile Summary	
Responsible Person:	
Published On:	06/29/2017
Last Full Review Completed On:	02/27/2017
Writer:	
Document Status:	Active
Document Type:	GAS
Category (Prior FCD system only):	
If Merged, Merged To Document Number:	
Utility:	SoCalGas
Department:	Gas Operations & System Integrity
Number of Common Document (if applicable):	
Contains OPQUAL Covered Task:	No
Part of SoCalGas O&M Plan:	Yes
Part of SDG&E O&M Plan:	No
Last O&M Review date:	2017-08-23
O&M 49 CFR Codes & Impacted Sections of Document:	192.605(b)(5); Entire Document
Part of Non-O&M Parts 191-193 Plan	No
Non-O&M 49 CFR Codes & Impacted Sections of Document	
Part of Distribution IMP (DIMP)	No
Part of Transmission IMP (TIMP)	No
Part of Storage IMP (SIMP)	No
Impacts GO112F	No
GO112F Codes & Impacted Sections of Document	
Impacts GO58A	No
GO58A Codes & Impacted Sections of Document	
Impacts GO58B	No
GO58B Codes & Impacted Sections of Document	
Indices/Binders in Which Document is Filed:	TRAN, STOR, PSEP, PCF, PC, MR, MS, DISTM, CM, CF
NOP Learning Module (LM) Training Code:	NOP00410



**Company Operations Standard
Gas Standard
Gas Engineering**

Purging Pipelines and Components	SCG:	182.0160
---	-------------	-----------------

PURPOSE This gas standard provides the policy and procedures for safely purging natural gas pipelines. All company and contract employees shall follow these guidelines when purging pipeline systems.

1. POLICY AND SCOPE

- 1.1. Pipelines are purged to prevent the presence of a combustible mixture of gas and air. Failure to abide by the guidelines and procedures of this Gas Standard may result in serious or catastrophic consequences.
- 1.2. This procedure does not include purging operations that utilize air movers. For these purges, see [GS 187.0103](#), *Purging Pipelines Using Air Movers For Cold Tie Operations*.
- 1.3. The Purging Operation Supervisor shall conduct a meeting, prior to a purging activity, to ensure all personnel engaged in purging operations understand the procedures involved. The Purging Operation Supervisor shall ensure that all employees and contractors involved in purging understand the potential hazards of improper operation. If changes in operations occur, all personnel will be informed of the changes before proceeding.
- ~~1.3.1.4.~~ Any project that requires gas blown to atmosphere will build time into the project schedule to reduce methane consistent with safe operations and consider alternative potential sources of supply to reliably serve customers and maintain feasibility. Operating pressure should be reduced to the lowest operationally feasible level in order to minimize methane emissions before non-emergency venting of high-pressure distribution (above 60 psig), transmission and underground storage infrastructure consistent with safe operations, and whenever practicable, work should be bundled to prevent multiple venting of the same piping.
- ~~1.4.1.5.~~ Written procedures shall be understood and approved by the Purging Operation Supervisor so as to assure the safe and successful completion of the job. See Section 4.2.8 for further details about the written plan.
- ~~1.5.1.6.~~ Limit access to the work area of the purging operation to only those persons who are necessary to perform the activity, keeping all-non-essential personnel and the public clear of harm's way.
- ~~1.6.1.7.~~ All personnel directly involved in purging shall be outfitted with personal protective equipment including ear and eye protection, gas monitors, gloves, head protection, etc.
- ~~1.7.1.8.~~ Gas shall be vented into the atmosphere without hazard to workers, public and property.

Formatted: Font color: Red

Formatted: Font: (Default) +Body (Calibri), 11 pt, Font color: Red

Formatted: Font color: Red



**Company Operations Standard
Gas Standard
Gas Engineering**

Purging Pipelines and Components	SCG:	182.0160
---	-------------	-----------------

1.8-1.9. Considerations must be given to the public with regard to objectionable noise and odor as well as any noise or pollution abatement requirements. Such considerations may include the use of noise suppression equipment, notification of law enforcement, Fire Department and Air Pollution Control District.

1.9-1.10. All parts and equipment involved in the purging operation shall be in proper working condition and are visually inspected before use.

1.10-1.11. Adequate visual and/or radio communications shall be established between all work locations including the injection and venting points.

1.11-1.12. Fire extinguishers are manned and readily available at injection, vent, and upwind of the vent location.

1.12-1.13. When purging out-of-service follow procedures stated in [GS 182.0032](#), *Blowdown Time, Sizing, and Volume Calculations* and [Form 3466](#), *Reporting of Gas Blown to Atmosphere* to account for the gas lost to atmosphere.

1.13-1.14. Sources of Ignition.

1.13.1-1.14.1. All possible sources of ignition shall be eliminated, including but not limited to; standing pilots, open flames, cigarettes, operating appliances and equipment. See [GS 166.0025](#), *Prevention of Accidental Ignition of Natural Gas*. Cathodic protection rectifiers shall be turned off.

1.13.2-1.14.2. Ground all machinery, pipes, squeeze tool, and other equipment where static electricity might accumulate. A static electric charge can build up on both the inner and the outer surface of the PE piping. See [GS 184.0160](#), *Control of Static Electricity on Polyethylene (PE) Pipe*.

1.13.3-1.14.3. Pipelines are bonded or grounded before purging, cutting, or disconnecting. See [GS 184.0230](#), *Bonding Steel Mains and Services*.

1.13.4-1.14.4. When purging, especially with old piping, it shall be kept in mind that purging removes only gaseous or volatile materials. Undetected liquid or solid combustibles can be ignited by sparks carried back into a purged pipeline when it is cut. Take necessary precautions to ensure removal of difficult to detect combustibles. Consider purging with the Total Displacement Method with nitrogen if the presence of liquids or solids exists. See Section 3.4 for definition of Total Displacement Purge.

1.13.5-1.14.5. When selecting venting locations, care is taken to prevent accidental ignition during purging operations. Avoid venting under or in close proximity to overhead power lines.



**Company Operations Standard
Gas Standard
Gas Engineering**

Purging Pipelines and Components	SCG:	182.0160
---	-------------	-----------------

~~1.13.6~~1.14.6 Never discharge purging medium through a plastic vent pipe.

~~1.14~~1.15 Isolation

~~1.14.1~~1.15.1 Before purging, completely isolate piping from the system.

~~1.14.2~~1.15.2 Isolation may be accomplished by one or more methods including the use of blind flanges, closing valves, placing blanking discs between flanges, pressure control fittings or physically disconnecting laterals or other sources of gas. Squeezing of plastic pipe may be an acceptable means of isolation. Only approved squeeze tools that achieve a gastight seal shall be used. Care shall be taken to avoid static electrical discharge before, during and after purge (see [GS 184.0160](#), *Control of Static Electricity on Polyethylene (PE) Pipe*). The squeeze tool shall be grounded before applying the squeezer to the pipe in a potentially hazardous atmosphere. See [GS 184.0340](#), *Squeezing PE Plastic Pipe - 1/2" Through 8"*.

~~1.14.3~~1.15.3 If valves are used to isolate the purged section from the energized system, they should be verified to stroke properly and not to leak.

~~1.14.4~~1.15.4 A thorough physical check shall be made to ensure that isolation is prepared as planned and free of leakage before the start of the purging operation.

~~1.15~~1.16 Nitrogen

~~1.15.1~~1.16.1 When using nitrogen as a separating medium, practicality, availability and economics determine whether to use cylinders (bottles) or a tank truck. A tank truck is normally the less costly option when a large volume of nitrogen is required.

~~1.15.2~~1.16.2 Standard cylinders have 250 standard cubic feet of nitrogen at 2265 psig.

~~1.16~~1.17 Venting Through Wet Canvas Temporary End Closures

~~1.16.1~~1.17.1 If a new Transmission pipeline assembly is enclosed with wet canvases, the assembly may be directly purged into service using one canvas end as a vent provided that:

~~1.16.1.1~~1.17.1.1 When purging through a wet canvas, the canvas opening should be approximately 1/3 of the cross-section of the pipe. The opening is at the bottom when purging into service. See [GS 223.016](#), *Temporary End Closures*.



**Company Operations Standard
Gas Standard
Gas Engineering**

Purging Pipelines and Components	SCG:	182.0160
---	-------------	-----------------

~~4.17-1.18.~~ Any deviation from this gas standard shall be reviewed and approved by **Gas Engineering - Pipeline Engineering**.

2. RESPONSIBILITIES AND QUALIFICATIONS

- 2.1. **Distribution Region, Transmission District or Storage Facility Planning Office** Purging Planner, or the District Operations Manager, shall prepare the written purging procedures. See Section 4.2.8 for further requirements.
- 2.2. **Purging Operation Supervisor** shall be responsible for supervising purging operations. The Supervisor shall have thorough technical knowledge and previous purging experience.
- 2.3. **Distribution Region, Transmission District and Storage Facility** personnel performing purging activities shall be Operator Qualified. Review [GS 167.0100, Operator Qualification Program](#) for requirements.

3. DEFINITIONS

- 3.1. "Purge" - The act of removing all of the air from a pipeline and replacing it with natural gas or removing all natural gas from a pipeline and replacing it with air.
- 3.2. "Direct Purge" – The act of either directly purging gas with air or air with gas at high velocities **without** a nitrogen slug.
- 3.3. "Indirect Purge" – The act of either purging from gas to air or from air to gas **with** a nitrogen slug between the air and gas to prevent the formation of a combustible mixture.
- 3.4. "Total Displacement Purge" – The act of purging from gas to air or air to gas by injecting an amount of nitrogen slightly greater than the entire internal volume of the pipeline or facility.
- 3.5. "Slug" – A quantity of injected nitrogen gas interposed between the gas and air during an indirect purge. The slug moves through the pipe as a distinct mass to prevent mixing of the gas and air.
- 3.6. "Blow-down" - To reduce pipeline pressure to atmospheric pressure by venting gas to atmosphere.
- 3.7. "Purging out of service" – (*Gas to Air/Nitrogen*) The process of replacing natural gas content in a pipeline with air/ nitrogen by injecting air or nitrogen at sufficiently high flow rates.



**Company Operations Standard
Gas Standard
Gas Engineering**

Purging Pipelines and Components	SCG:	182.0160
---	-------------	-----------------

3.8. “Purging into Service” – (*Air/Nitrogen to Gas*) The process of replacing air or nitrogen content in a pipeline with natural gas by injecting natural gas at sufficiently high flow rates.

4. PROCEDURE

4.1. Select the proper purging procedure with the given combination of pipe diameter and length using Table 1 below.

DRAFT SB 1371



**Company Operations Standard
Gas Standard
Gas Engineering**

Purging Pipelines and Components	SCG:	182.0160
---	-------------	-----------------

**Table 1.
Purging Method**

Diameter (in)	Length (ft)	Purging Method
$D \leq 4$	Any	Direct (Section 5)
$D \geq 6$	$L < 500$	Direct (Section 5)
$D \geq 6$	$L \geq 500$	Indirect (Section 7)

Note:

1. The Total Displacement Method (Section 9) shall be used when:
 - A potential hazard exists due to the presence of liquids or solids.
 - A potential hazard exists due to a complex piping situation, such as with stubs, or in compressor and regulator stations.
 - Permanently abandoning a pipeline or main that is not free of liquids or solids, or if required by the permitting agency. (See [GS 184.0085](#), *Abandonment or Inactivation of Gas Distribution Pipelines*, or [GS 223.0130](#), *Abandonment, Conversion and Reinstatement of Transmission Pipelines*.)
2. Air Movers may be used for purging large diameter (≥ 8 ") pipelines out of service; see [GS 187.0103](#), *Purging Pipelines Using Air Movers For Cold Tie Operations*.
3. For Abandonment of Distribution Mains and Services see [GS 184.0080](#), *Abandonment of Gas Services and Gas Light Tap Assemblies* and [GS 184.0085](#), *Abandonment or Inactivation of Gas Distribution Pipelines*, for diameters and lengths of piping that do not require purging prior to abandonment.

4.2. Planning a Purge

- 4.2.1. Use Table A1 in Appendix A to obtain the standard purging parameters for particular pipe diameters. These parameters include the standard injection fittings, injection pressures, vent sizes and flow rates. If orifices are to be utilized, use the required minimum flow rates from Table A1*. Select the appropriate orifice size and inlet pressure based on required flow rates. Place the orifice immediately upstream of the injection fitting to eliminate any potential pressure drop. Orifices are normally placed in screwed orifice unions, but personnel can also utilize a tapped abandonment fitting. Injection



**Company Operations Standard
Gas Standard
Gas Engineering**

Purging Pipelines and Components	SCG:	182.0160
---	-------------	-----------------

and bypass fittings selected shall not have an internal diameter smaller than the hose or orifice to be used. See Figure 6 for typical orifice set up.

- 4.2.1.1. When using an orifice, the pressure gauge to measure minimum pressure should be installed just upstream of the orifice. The tapped diameter when using an abandonment fitting needs to be equal to or greater than the orifice size.
- 4.2.2. Use Table A2 in Appendix A to obtain an approximate arrival time at particular lengths when using a standard set up. When indirectly purging, this time indicates the arrival of the slug.
- 4.2.3. When purging out of service using an air compressor, make certain that the selected compressor is rated with at least 15% more flow rate capacity than the minimum flow rate listed in Table A1.
- 4.2.4. When possible, purge from air/nitrogen to gas downhill, and purge from gas to air/nitrogen uphill.
- 4.2.5. A piping system containing loops or branches requires a detailed evaluation to ensure each pipe section is properly isolated and purged which typically requires isolating and purging in stages.
- 4.2.6. Venting
- 4.2.6.1. See Table A1 for vent stack sizing.
- 4.2.6.2. The steel vent stack should consist of a full opening tap in the pipeline to be purged.
- 4.2.6.3. When a vent valve is used, it shall be full opening.
- 4.2.7. Nitrogen Volumes
- 4.2.7.1. If an Indirect Purge is required, use Table A3 in Appendix A to determine the minimum number of cylinders required. If the use of a nitrogen truck is desired, such as when large volumes are required, see Table A5 in Appendix A to obtain required nitrogen volumes.
- 4.2.7.2. If a Total Displacement Purge is required or desired, use Table A4 in Appendix A to determine the minimum number of cylinders required for a total displacement purge.
- 4.2.8. Written Plan



**Company Operations Standard
Gas Standard
Gas Engineering**

Purging Pipelines and Components	SCG:	182.0160
---	-------------	-----------------

- 4.2.8.1. An approved written plan should be available for all purging procedures.
- 4.2.8.2. Service lines and small diameter pipelines can be purged using the general procedures of this gas standard as the written plan. More complex purging operations require a specific detailed written plan.
- 4.2.8.3. The written plan should include, but is not limited to, the required purging method, location of isolation points, injection set up, injection pressures and flow rates, venting location and stack size, operational sequences, an equipment list (model of gas scope, air compressor, etc) and provisions for a communication system.
- 4.2.9. Non-Typical Purging Operations
- 4.2.9.1. When purging a service that has an Excess Flow Valve installed; see [GS 187.0146](#), *Excess Flow Valve (EFV) - Installation and Operation*.
- 4.2.9.2. If a standard indirect purge is not practical or possible, in cases such as long pipeline lengths yielding unreasonable operation times or if the use of larger injection fittings and/or vents is desired, contact **Gas Engineering - Pipeline Engineering** for analysis.
- 4.2.9.3. All non-standard purges require a written plan approved by **Gas Engineering - Pipeline Engineering**.



**Company Operations Standard
Gas Standard
Gas Engineering**

Purging Pipelines and Components	SCG:	182.0160
---	-------------	-----------------

5. Purging Out of Service using the Direct Purge Method (Gas to Air)

Figure 1. - Arrangement for Directly Purging Gas from Pipelines.

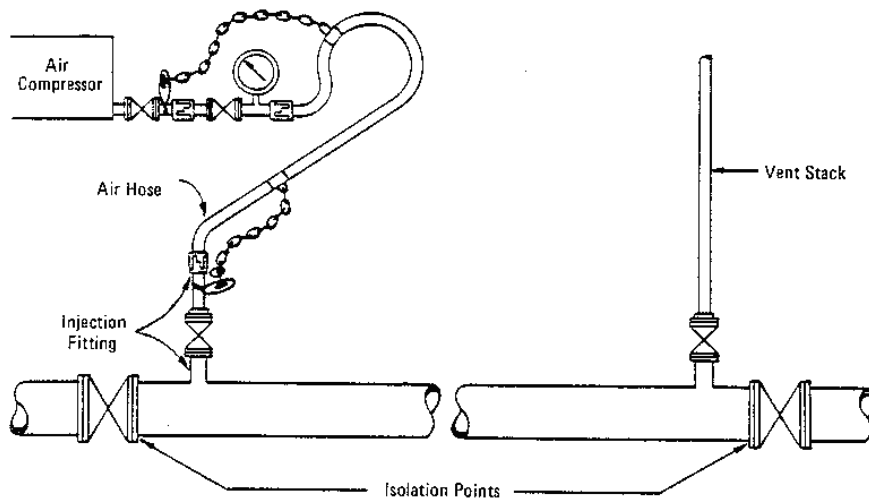

- 5.1. The Purging Operation Supervisor reviews the approved Written Plan and takes necessary actions to ensure all company policies are adhered to. See Section 4.2.8.
- 5.2. Remove all ignition sources in accordance with Section 1.13.
- 5.3. Isolate section of line to be purged. See Section 1.14.
- 5.4. If a properly sized vent is not available, install one as close as practical, but not more than 5 feet from venting end of the pipeline. Stack must extend to a safe location, 6 to 8 feet above ground level. See Figure 1.
- 5.5. Install injection fitting as close as practical, but not more than 5 feet from the injection end of pipeline. Connect air hose and valve to pressure gauge. See Figure 1.
- 5.6. Connect gauge and valve end of air hose to air compressor and attach other end of hose to injection fitting. See Figure 1.
- 5.7. Open valve on vent stack and blow down line.



**Company Operations Standard
Gas Standard
Gas Engineering**

Purging Pipelines and Components	SCG:	182.0160
---	-------------	-----------------

- 5.8. With the air compressor valve open, gradually open the valve on injection fitting and inject air. Inject at or above the minimum injection pressure. Injection of air shall be continued without interruption until the pipeline is purged of all gas. Control pressure with valve attached to compressor end of air hose. See Figure 1.
- 5.9. Stop injection of air when pipeline is purged of all gas. Use gravitometer or MSA gas scope or other approved devices to determine if pipeline is 100% purged of all gas. See [GS 223.0160](#). *Use of Portable Ranarex Gravimeters/Check Purges.*
6. Purging into Service using the Direct Purge Method (*Air/Nitrogen to Gas*)

Figure 2 - Arrangement for Directly Purging Pipelines into Service.

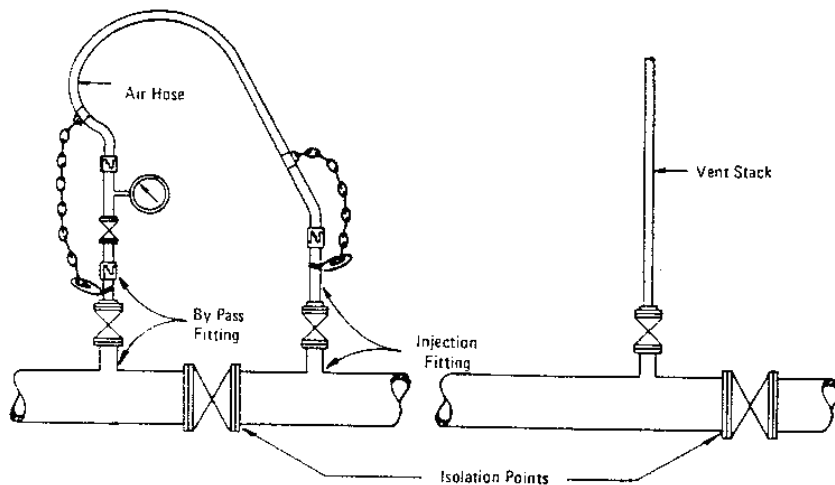

- 6.1. The Purging Operation Supervisor reviews the approved Written Plan and takes necessary actions to ensure all company policies are adhered to. See Section 4.2.8.
- 6.2. Remove all ignition sources in accordance with Section 1.13.
- 6.3. Isolate section of line to be purged. See Section 1.14.
- 6.4. If a properly sized vent is not available, install one as close as practical, but not more than 5 feet from venting end of the pipeline. Stack must extend to a safe location, 6 to 8 feet above ground level. See Figure 2.



**Company Operations Standard
Gas Standard
Gas Engineering**

Purging Pipelines and Components	SCG:	182.0160
---	-------------	-----------------

- 6.5. Install injection fitting as close as practical to, but not more than 5 feet away from the injection end of pipeline. See Figure 2. If available, gas may be injected by opening a line valve instead of using a bypass, however, contact **Gas Engineering - Pipeline Engineering** to obtain the downstream pressure needed to control the purge.
- 6.6. If needed, install bypass fitting on live pipeline for gas source. See Figure 2.
- 6.7. Connect gauge and valve to bypass fitting. Connect an air hose or high pressure hose from pressure gauge end to injection fitting. See Figure 2.
- 6.8. Open valve on vent stack.
- 6.9. Gradually open valve on injection fitting and inject gas. Inject at or above the minimum injection pressure. Injection of gas shall be continued without interruption until the pipeline is purged of all air. Control pressure with valve attached to bypass fitting. See Figure 2.
- 6.10. Stop injection of gas when pipeline is purged of air. Use gravitometer or MSA gas scope or other approved devices to determine if pipeline is 100% purged of all air. Use only the “% gas” range with gas scope. The “0-LEL” range is not accurate unless there is oxygen in the sample being tested. See [GS 223.0160, Use of Portable Ranarex Gravitometers/Check Purges](#).
- 6.11. A *cursory odor sniff test* (a quick release of natural gas into the atmosphere that is sniffed to determine if odorant is detectible by smell) shall be performed immediately after the purging process and verifying 100% gas is obtained.
- 6.12. For purging directly into service with high volume tapping tee and gas services less than 2” see Section 11.



**Company Operations Standard
Gas Standard
Gas Engineering**

Purging Pipelines and Components	SCG:	182.0160
---	-------------	-----------------

7. Purging Out of Service using the Indirect Purge Method (Gas to Air)

Figure 3. Arrangement for Purging Out of Service using Indirect Method

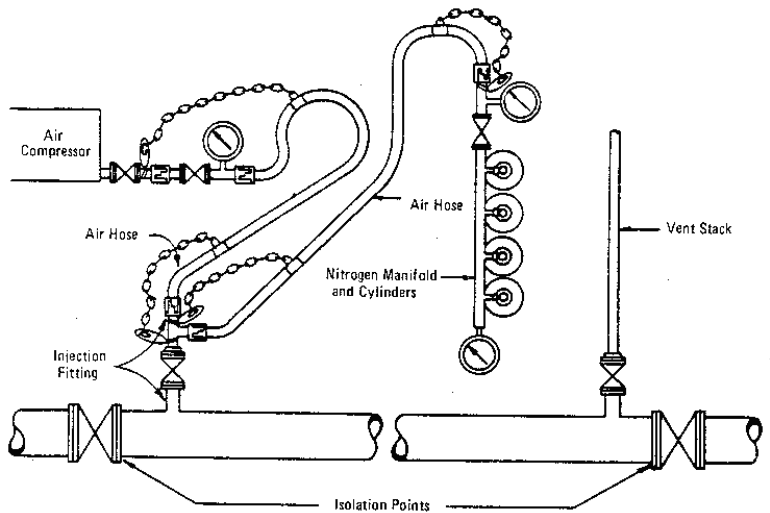

- 7.1. The Purging Operation Supervisor reviews the approved Written Plan and takes necessary actions to ensure all company policies are adhered to. See Section 4.2.8.
- 7.2. Remove all ignition sources in accordance with Section 1.13.
- 7.3. Isolate section of line to be purged. See Section 1.14.
- 7.4. If a properly sized vent is not available, install one as close as practical, but not more than 5 feet from venting end of the pipeline. Stack must extend to a safe location, 6 to 8 feet above ground level.
- 7.5. Install injection fitting as close as practical, but not more than 5 feet from the injection end of pipeline. See Figure 3.
- 7.6. Connect gauge and valve to air compressor and attach hose from the other end of the injection fitting. See Figure 3.
- 7.7. If nitrogen cylinders are to be used, connect the nitrogen cylinders to the manifold. Close valve on manifold and open valves on nitrogen cylinders. See Figure 3.
- 7.8. Connect manifold hose or high pressure hose to injection fitting. See Figure 3.



**Company Operations Standard
Gas Standard
Gas Engineering**

Purging Pipelines and Components	SCG:	182.0160
---	-------------	-----------------

- 7.9. Open valve on vent stack and blow-down the pipeline.
 - 7.10. Open valve on injection fitting. Be sure this valve is open to prevent damage to the gauge on the manifold.
 - 7.11. Inject nitrogen by gradually opening manifold valve. Inject at or above the minimum injection pressure controlling pressure with the manifold valve. See Figure 3.
 - 7.12. Begin injecting air as soon as the minimum gauge pressure of nitrogen, cannot be maintained. Close valve on nitrogen manifold immediately after air injection has started. Air must be injected at or above the minimum gauge pressure. Control pressure with valve attached to compressor end of air hose. See Figure 3.
 - 7.13. Stop injecting air when pipeline is 100% purged of all gas. Use gravitometer or MSA gas scope to determine if pipeline is purged of all gas. See [GS 223.0160, Use of Portable Ranarex Gravitometers/Check Purges.](#)
8. Purging Into Service using the Indirect Purge Method (Air/Nitrogen to Gas)

Figure 4. Arrangement for Purges into Service using Indirect Method

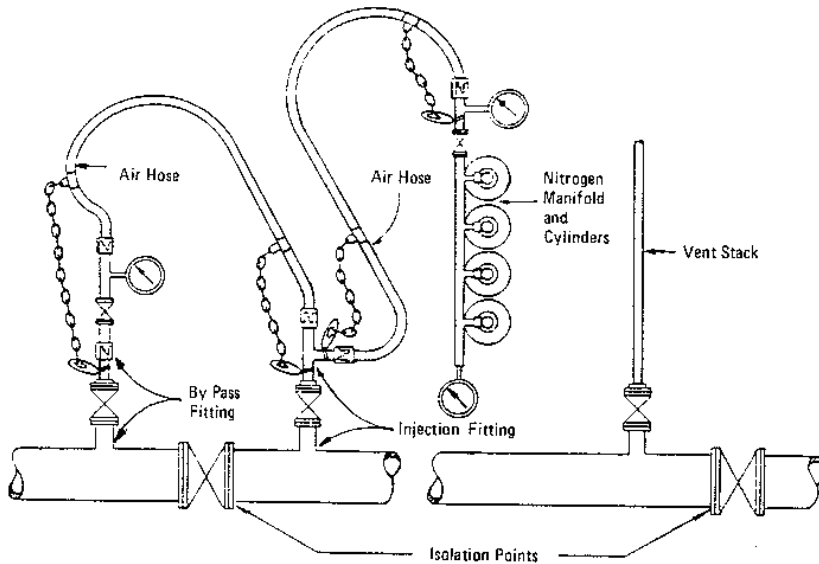

- 8.1. The Purging Operation Supervisor reviews the approved Written Plan and takes necessary actions to ensure all company policies are adhered to. See Section 4.2.8.



**Company Operations Standard
Gas Standard
Gas Engineering**

Purging Pipelines and Components	SCG:	182.0160
---	-------------	-----------------

- 8.2. Remove all ignition sources in accordance with Section 1.13.
- 8.3. Isolate section of line to be purged. See Section 1.14.
- 8.4. If a properly sized vent is not available, install one as close as practical, but not more than 5 feet from venting end of the pipeline. Stack must extend to a safe location, 6 to 8 feet above ground level.
- 8.5. Install injection fitting as close as practical, but not more than 5 feet from the injection end of pipeline. See Figure 4. If available, gas may be injected by opening a line valve instead of using a bypass, however, contact **Gas Engineering - Pipeline Engineering** to obtain the downstream pressure needed to control the purge.
- 8.6. If needed, install bypass fitting on pipeline as a gas source. See Figure 4.
- 8.7. Connect gauge and valve to bypass fitting. Connect an air hose or high pressure hose from pressure gauge end to injection fitting. See Figure 4.
- 8.8. Connect nitrogen cylinders to the manifold. Close valve on manifold and open valves on nitrogen cylinders.
- 8.9. Connect manifold hose or high pressure hose to injection fitting. See Figure 4.
- 8.10. Open valve on vent stack.
- 8.11. Inject nitrogen by gradually opening manifold valve. Inject at or above the minimum injection pressure controlling pressure with the manifold valve. See Figure 4.
- 8.12. Begin injecting gas as soon as the minimum gauge pressure of nitrogen, cannot be maintained. Close valve on nitrogen manifold immediately after gas injection has started. Gas must be injected at or above the minimum gauge pressure. Control pressure with valve attached to bypass fitting. See Figure 4.
- 8.13. Stop injecting gas when pipeline is 100% purged of air. Use gravitometer or MSA gas scope to determine if pipeline is purged of all air. Use only the “% gas” range with gas scope. The “0-LEL” range is not accurate unless there is oxygen in the sample being tested. See [GS 223.0160, Use of Portable Ranarex Gravitometers/Check Purges](#).
- 8.14. A *cursor odor sniff test* (a quick release of natural gas into the atmosphere that is sniffed to determine if odorant is detectible by smell) shall be performed immediately after the purging process and verifying 100% gas is obtained.



**Company Operations Standard
Gas Standard
Gas Engineering**

Purging Pipelines and Components	SCG:	182.0160
---	-------------	-----------------

9. Purging Out of Service using the Total Displacement Purge Method (Gas to Nitrogen)

Figure 5. Arrangement for Purging Out of Service using Total Displacement Method

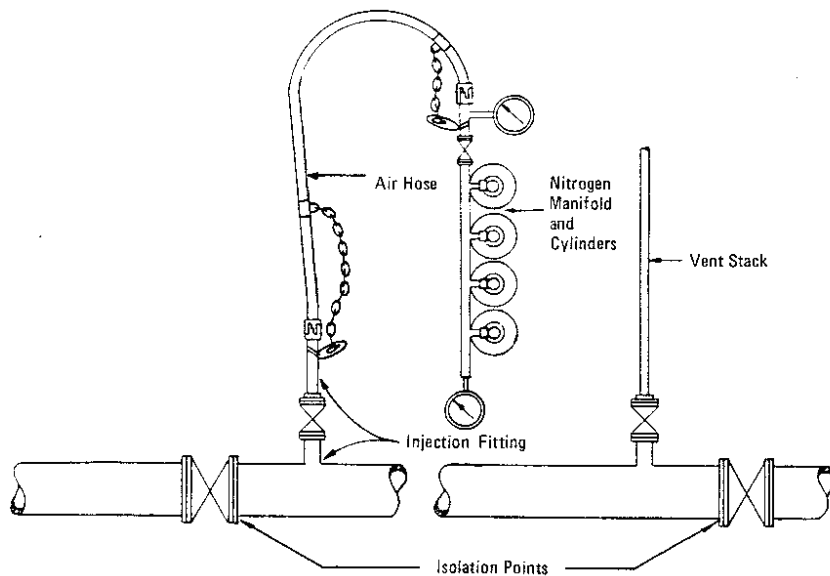

- 9.1. The Purging Operation Supervisor reviews the approved Written Plan and takes necessary actions to ensure all company policies are adhered to. See Section 4.2.8.
- 9.2. Remove all ignition sources in accordance with Section 1.13
- 9.3. Isolate section of line to be purged. See Section 1.14.
- 9.4. If a properly sized vent is not available, install one as close as practical, but not more than 5 feet from venting end of the pipeline. Stack must extend to a safe location, 6 to 8 feet above ground level.
- 9.5. Install injection fitting as close as practical from the injection end of pipeline.
- 9.6. If nitrogen cylinders are to be used, connect the nitrogen cylinders to the manifold. Close valve on manifold and open valves on nitrogen cylinders. See Figure 5.
- 9.7. Connect manifold hose to injection fitting. See Figure 5.



**Company Operations Standard
Gas Standard
Gas Engineering**

Purging Pipelines and Components	SCG:	182.0160
---	-------------	-----------------

- 9.8. Open valve on vent stack and blow-down the pipeline.
- 9.9. Open valve on injection fitting. Be sure this valve is open to prevent damage to the gauge on the manifold. See Figure 5.
- 9.10. Inject nitrogen by gradually opening manifold valve. Inject at or above the minimum injection pressure controlling pressure with the manifold valve. See Figure 5.

NOTE: When abandoning a pipeline using the Total Displacement Method stop injection once pipeline is completely purged of gas then proceed in capping the pipe.

- 9.11. Stop injecting nitrogen when pipeline is 100% purged of all gas. Use gravitometer or MSA gas scope to determine if pipeline is purged of all gas. Use only the “% gas” range with the gas scope. The “0-LEL” range is not accurate unless there is oxygen in the sample being tested. See [GS 223.0160](#), *Use of Portable Ranarex Gravitometers/Check Purges*.
- 9.12. Sections with pipe left with 100% nitrogen must be stenciled “Nitrogen”. Also adjoining valves must be stenciled “Nitrogen”.



**Company Operations Standard
Gas Standard
Gas Engineering**

Purging Pipelines and Components	SCG:	182.0160
----------------------------------	------	----------

10. Typical Orifice Set Up

**Figure 6. Direct Method with Orifice and pressure gauge relocated closer to orifice.
(Direct Purging)**

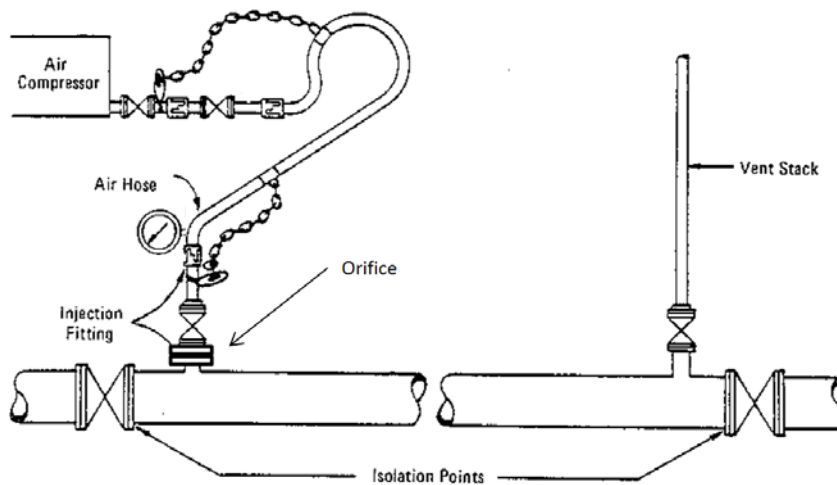

11. Special Instruction For Purging Directly Into Service With High Volume Tapping Tee and Gas Services Less Than 2"

11.1. Direct purging into service a new 2 inch medium pressure PE Main with high volume tapping tee as a pressure control fitting connected from 6" or 8" header main.

11.1.1. Use the high volume tapping tee as a pressure control fitting. It is not necessary to use a 50 ft. bypass hose to directly purge the new main into service. The high volume tapping tee will become the purge source.

11.1.2. Install the high volume tapping tee in accordance with [GS 184.0115](#), *Tapping/ Stopping PE Fittings*.

11.1.3. Tie new main onto the high volume tapping tee and leak test per [GS 184.0150](#), *Leak Testing of Distribution Piping*.

11.1.4. Blow down the medium used for leak testing.



**Company Operations Standard
Gas Standard
Gas Engineering**

Purging Pipelines and Components	SCG:	182.0160
---	-------------	-----------------

- 11.1.5. Ensure vent-stack is in place, grounded and control valve is open. See [GS 184.0160](#), *Control of Static Electricity on Polyethylene (PE) Pipe* for purge assemblies and proper grounding.

NOTE: Using a properly sized 50 ft. bypass hose is also allowed, but squeezing the 2" PE pipe next to the outlet of the high volume tapping tee will be needed. Squeezing needs to be performed before directly purging the new main into service has begun in order isolate "back fed" gas from the bypass connection. The squeezer can be released after the high volume tapping tee has been installed, tapped, capped, and sealed.

- 11.1.6. Ensure the ratchet wrench is grounded then place tapping tool and start tapping per [GS 184.0115](#) *Tapping/Stopping PE Fittings*. To seal off the gas flow, thread the cutter down until it seats in the main, thus shutting off the gas flow.
- 11.1.6.1. The high volume tapping tee will now act as a pressure control fitting to directly purge the new main into service.
- 11.1.7. The crew member located at the vent stack is to maintain the control valve fully open and ready for the purge to commence.
- 11.1.8. Test at purge point with an approved combustible gas indicator until 100% gas is obtained at the riser outlet. Use gravitometer or MSA gas scope or other approved devices to determine if pipeline is 100% purged of all medium. See [GS 223.0160](#), *Use of Portable Ranarex Gravitometers/Check Purges*.
- 11.1.9. Begin backing off the high volume tapping tee and introduce natural gas purge to the new 2" main.
- 11.1.10. Close the control valve once test at the purge point with an approved combustible gas indicator indicates 100% gas at the vent stack outlet. The new main is now pressurized and purged into service.
- 11.2. Direct purging of gas services less than 2" steel can be accomplished using a service tee or pin off tee as the purge source.



**Company Operations Standard
Gas Standard
Gas Engineering**

Purging Pipelines and Components	SCG:	182.0160
---	-------------	-----------------

12. OPERATOR QUALIFICATION COVERED TASKS
(See [GS 167.0100](#), *Operator Qualification Program, Appendix A, Covered Task List*)
- **Task 07.01** - 49 CFR 192.629 – Purging pipelines
 - **Task 16.02** - 49 CFR 192.745 – Inspecting, operating, and maintaining transmission pipeline valves
 - **Task 16.03** - 49 CFR 192.747 – Inspecting, operating, and maintaining distribution system valves
13. EXCEPTION PROCEDURE
(See [STANDARD 182.0004](#), *Exception Procedure for Company Operations Standards*)
- 13.1. An exception to this standard shall be considered only after practical solutions have been exhausted. Safety issues shall be given primary consideration, while adhering to governing codes before an approval of an exception is granted.
- 13.2. An exception from a standard shall not be allowed unless [GS 182.0004](#) is followed and approval is given by the Responsible Person (RP) for the standard or by someone in that person's organization that has been granted authority, and by others as required by 182.0004, and if specified in the standard from which the exception is requested.
14. RECORDS
Not Applicable.
15. APPENDICES
- 15.1. Appendix A



**Company Operations Standard
Gas Standard
Gas Engineering**

Purging Pipelines and Components	SCG:	182.0160
---	-------------	-----------------

APPENDIX A

**Table A1
Minimum Equipment Requirements for Purging Pipeline**

Nominal Pipe Size (inches)	Hose Diameter** (inches)	Minimum Nominal Stack Stack Size*** (inches)	Minimum Gauge Pressure *		Minimum Injection Flow Rate (SCFM)
			Gas (psig)	Nitrogen/Air (psig)	
4 and less	3/4	3/4	3	3	11
6	3/4	1 -1/2	6	8	29
8	3/4	1 -1/2	15	18	56
10	3/4	2	28	35	96
12	3/4	3	47	59	149
16	1 1/4	3	19	26	273
18	1 1/4	4	28	40	367
20	1 1/4	4	41	55	489
22	1 1/4	4	55	75	615
26	2	6	21	30	930
30	2	6	32	45	1331
34	2	6	45	65	1821
36	2	6	54	77	2117

* Pressures listed are based upon placing a pressure gauge 50 feet upstream of the injection point. Shorter distances yield greater injection rates and shorten purge durations. Contact **Gas Engineering - Pipeline Engineering** if hose distances are greater than 50 feet.

** If it's necessary to use a Hose Diameter larger than specified, contact **Gas Engineering - Pipeline Engineering** for the lower required minimum gauge pressure.

*** For vents in excess of 10 ft long, go to next larger pipe size. Multiple vent stacks are allowed if a single vent stack does not meet the minimum requirements. The total internal flow area of the multiple vents needs to be greater to the internal flow area of the required vent size. Contact **Gas Engineering - Pipeline Engineering** for guidance on correct combinations of vent stacks.

Note: The diameter of manifolds should at least be equal to the hose diameter required for purging.



**Company Operations Standard
Gas Standard
Gas Engineering**

Purging Pipelines and Components	SCG:	182.0160
---	-------------	-----------------

Table A1*
Measuring Rates Through Orifices
Use these figures for measuring the injection rates while purging.
(Note: All Hose and Orifice Sizes are Internal Diameters)

Inject Rate (cfm)	Pressure Upstream of Orifice (psig) (Note: All Hose and Orifice Sizes are Internal Diameters)									
	Orifice Size (inches)									
	3/8		1/2		5/8		3/4		7/8	
	Gas	N ₂ Air	Gas	N ₂ Air	Gas	N ₂ Air	Gas	N ₂ Air	Gas	N ₂ Air
10										
20										
40	7	12								
60	19	26	5	8						
80	30	39	11	16	2	5				
100	41	53	18	24	6	10				
120	52	67	25	31	10	14				
140	63	80	31	39	14	19				
160	75	94	38	47	19	24				
180	86	107	44	54	23	29				
200	97	121	51	62	27	34				
220	106	136	53	70	29	39	17	22	9	13
240	117	150	59	78	33	44	20	26	11	15
260	128	163	66	85	37	49	22	29	13	18
280	139	177	72	93	41	54	25	33	15	20
300	150	191	78	101	45	59	28	36	17	23
320	161	205	84	109	49	64	31	39	19	25
340	172	218	90	116	53	69	34	43	21	28
360	183	232	97	124	57	74	37	46	24	30
380	194	246	103	132	61	78	40	50	26	33
400	205	259	109	139	65	83	43	53	28	35
420	216	273	115	147	69	88	45	56	30	38
440	227	287	121	155	73	93	48	60	32	40
460	238	301	128	163	77	98	51	63	34	43
480	249	314	134	170	81	103	54	67	36	45
500	260	328	140	178	85	108	57	70	39	48
550	286	362	156	197	95	120	61	79	41	53
600	314	397	171	217	105	133	68	87	46	59
650	341	431	187	236	115	145	75	96	51	65
700	369	465	202	255	125	157	82	104	56	71
750	396	500	218	275	135	170	89	113	62	77
800	423	534	233	294	145	182	95	121	67	83
850	451	568	249	313	155	194	102	130	72	90
900	478		264	332	165	206	109	138	77	96
950	506		280	352	175	219	116	147	82	102
1000	533		295	371	185	231	123	155	87	108
1050	560		311	390	195	243	130	164	92	114
1100	588		326	410	205	256	137	172	97	120
1150			342	429	215	268	144	181	102	126
1200			357	448	225	280	151	189	107	133
1250			373	468	235	293	158	198	113	139
1300			388	487	245	305	164	206	118	145
1350			404	506	255	317	171	215	123	151
1400			419	525	265	329	178	223	128	157
1450			435	545	275	349	185	232	133	163
1500			450	564	285	354	192	240	138	170
1550			466	583	295	366	199	249	143	176
1600			481		305	379	206	257	148	182
1650			497		315	391	213	266	153	188
1700			512		325	403	220	274	158	194
1750			528		335	416	227	283	164	200
1800			543		345	428	233	291	169	206
1850			559		355	440	240	300	174	213
1900			574		365	452	247	308	179	219
1950			590		375	465	254	317	184	225
2000					385	477	261	325	189	231
2050					395	489	268	334	194	237
2100					405	502	275	342	199	243



**Company Operations Standard
Gas Standard
Gas Engineering**

Purging Pipelines and Components	SCG:	182.0160
---	-------------	-----------------

Table A1 (continued)*
Measuring Rates Through Orifices
 Use these figures for measuring the injection rates while purging.
 (Note: All Hose and Orifice Sizes are Internal Diameters)

Inject Rate (cfm)	Pressure Upstream of Orifice (psig) (Note: All Hose and Orifice Sizes are Internal Diameters)							
	Orifice Size (inches)							
	1-1/8		1-3/8		1-1/2		1-3/4	
	Gas	N ₂ Air	Gas	N ₂ Air	Gas	N ₂ Air	Gas	N ₂ Air
10								
20								
40								
60								
80								
100								
120								
140								
160								
180								
200								
220		2						
240		3						
260	2	5						
280	3	6						
300	4	8						
320	5	9						
340	7	11						
360	8	12						
380	9	14						
400	11	15						
420	12	17						
440	13	18						
460	14	20						
480	16	21						
500	17	23						
550	20	26	9	13				
600	23	30	11	15				
650	26	34	13	18				
700	29	38	15	20				
750	32	41	17	23				
800	35	45	19	25				
850	39	49	22	28				
900	42	53	24	30				
950	45	56	26	33				
1000	48	60	28	35	18	26	9	15
1050	51	64	30	38	20	28	10	17
1100	54	68	32	40	21	30	11	18
1150	57	71	34	43	23	32	13	20
1200	61	75	37	45	25	34	14	21
1250	64	79	39	48	26	36	15	23
1300	67	83	41	50	28	38	16	24
1350	70	86	43	53	30	40	17	26
1400	73	90	45	55	31	42	19	27
1450	76	94	47	58	33	44	20	29
1500	80	98	50	60	35	47	21	30
1550	83	101	52	63	36	49	22	32
1600	86	105	54	65	38	51	23	33
1650	89	109	56	68	39	53	25	35
1700	92	113	58	70	41	55	26	36
1750	95	116	60	73	43	57	27	38
1800	98	120	62	75	44	59	28	39
1850	102	124	65	78	46	61	29	41
1900	105	128	67	80	48	63	31	42
1950	108	131	69	83	49	65	32	44
2000	111	135	71	85	51	67	33	45
2050	114	139	73	88	53	69	34	47
2100	117	143	75	90	54	71	35	48



**Company Operations Standard
Gas Standard
Gas Engineering**

Purging Pipelines and Components	SCG:	182.0160
---	-------------	-----------------

Table A2**

Pipe Size (in.)	Estimated Duration of Purge (min)									
	Length of Pipe (feet)									
	1000	2000	3000	4000	5000	6000	8000	10000	20000	50000
4 and less	8	16	24	32	40	48	64	80	160	400
6	8	16	23	31	39	46	62	77	154	385
8	7	14	20	27	34	40	54	67	134	334
10	6	12	18	25	31	37	49	61	122	303
12	6	11	17	22	28	34	45	56	111	278
16	5	10	15	19	24	29	38	48	96	238
18	5	9	14	18	23	28	37	46	91	228
20	5	9	13	17	22	26	34	43	85	213
22	4	8	13	16	21	25	33	41	82	205
26	4	8	12	15	19	23	30	38	76	189
30	4	7	11	14	18	21	28	35	70	176
34	4	7	10	13	17	20	27	33	66	164
36	3	7	10	13	16	19	26	32	64	159

Values of time for length not shown may be interpolated. For assistance with interpolation, contact **Gas Engineering - Pipeline Engineering.



**Company Operations Standard
Gas Standard
Gas Engineering**

Purging Pipelines and Components	SCG:	182.0160
---	-------------	-----------------

**Table A3
Number of Nitrogen Cylinders (250 Cubic Feet Each) Required To Form Slug in Pipeline
Indirect Method**

Pipe Size (inches)	Pipe Length (ft)									
	500**	1000	2000	3000	4000	5000	7500	10,000	20,000	50,000
4	1	1	1	1	1	1	1	1	1	1
6	1	1	1	1	1	1	1	1	1	2
8	1	1	1	1	1	1	1	1	2	2
10	1	1	1	1	2	2	2	2	2	3
12	1	1	2	2	2	2	2	2	3	4
16	2	2	2	2	3	3	3	4	5	7
18	2	2	3	3	3	4	4	5	6	9
20	2	3	3	4	4	4	5	6	7	11
22	3	3	4	4	5	5	6	7	9	13
26	4	4	5	6	6	7	8	9	12	18
30	5	5	7	8	8	9	11	12	16	24
34	6	7	9	11	12	13	15	17	23	35
36	7	8	10	12	13	15	17	19	26	39

** Pipelines less than 500 ft may be displaced directly with air or gas. Please refer to **Table 1** "Purging Method" in this Gas Standard for additional guidance.



**Company Operations Standard
Gas Standard
Gas Engineering**

Purging Pipelines and Components	SCG:	182.0160
---	-------------	-----------------

**Table A4
Number of Nitrogen Cylinders (250 Cubic Feet Each) Required To Fill Pipeline
Total Displacement Method**

Pipe Size (inches)	Pipe Length (ft)										
	500	1000	2000	3000	4000	5000	6000	8000	10,000	20,000	50,000
2	1	1	1	1	1	1	1	1	2	3	5
3	1	1	1	1	1	2	2	2	3	5	11
4	1	1	1	2	2	3	3	4	5	9	19
6	1	1	2	3	4	5	6	8	10	19	*42
8	1	2	4	5	7	9	10	13	17	*33	*74
10	2	3	6	8	11	13	16	21	26	*52	*116
12	2	4	8	11	15	19	22	29	*37	*73	*164
16	3	6	12	17	23	28	*34	*45	*56	*112	*254
18	4	8	15	22	29	*36	*43	*58	*72	*143	*325
20	5	9	18	27	*36	*45	*54	*72	*89	*178	*405
22	6	11	22	*33	*44	*55	*66	*87	*109	*217	*494
26	8	16	31	*46	*62	*77	*92	*123	*154	*307	*696
30	11	21	*42	*62	*83	*103	*124	*165	*206	*411	*934
34	14	27	*54	*80	*107	*133	*160	*213	*266	*531	*1206
36	15	30	*60	*90	*120	*150	*179	*239	*299	*597	*1356

* Consider using a nitrogen truck for purges. See Table A5 for volume in SCF.

**Table A5
Volume (SCF) of Nitrogen Required To Form Slug in Pipeline
Indirect Method**

Pipe Size (inches)	*Pipe Length in Feet						
	2000	3500	5000	7500	10,000	20,000	50,000
12	263	321	368	433	486	653	985
16	430	527	605	712	802	1080	1632
18	553	677	777	915	1030	1387	2097
20	689	844	968	1139	1283	1728	2611
22	831	1017	1168	1375	1548	2085	3151
26	1162	1424	1633	1923	2165	2916	4406
30	1546	1895	2173	2561	2880	3880	5863
34	2204	2722	3137	3711	4189	5677	8630
36	2480	3067	3531	4179	4716	6391	9714

*Consider using bottles for smaller diameters and shorter lengths.



**Company Operations Standard
Gas Standard
Gas Engineering**

Purging Pipelines and Components	SCG:	182.0160
---	-------------	-----------------

**Table A6
Volume (SCF) of Nitrogen Required To Fill Pipeline
Total Displacement Method**

Pipe Size (inches)	Pipe Length in Feet										
	500	1000	2000	3000	4000	5000	6000	8000	10,000	20,000	50,000
6	*116	*231	*461	*691	*921	*1,151	*1,381	*1,840	*2,300	4,600	11,498
8	*202	*403	*805	*1,206	*1,608	*2,010	*2,412	*3,215	4,019	8,037	20,091
10	*320	*639	*1,277	*1,915	*2,552	*3,190	*3,828	5,104	6,379	12,758	31,893
12	*451	*902	*1,802	*2,703	*3,604	4,504	5,405	7,206	9,007	18,014	45,032
16	*699	*1,397	*2,792	4,188	5,584	6,979	8,375	11,166	13,957	27,914	69,782
18	*894	*1,786	*3,571	5,357	7,142	8,927	10,712	14,283	17,853	35,705	89,261
20	*1,112	*2,224	4,447	6,670	8,893	11,116	13,339	17,784	22,230	44,459	111,147
22	*1,357	*2,713	5,425	8,136	10,848	13,560	16,272	21,695	27,119	54,237	135,591
26	*1,915	*3,828	7,655	11,482	15,309	19,136	22,964	30,618	38,272	76,543	191,355
30	*2,568	5,134	10,268	15,401	20,534	25,668	30,801	41,068	51,334	102,668	256,668
34	*3,316	6,632	13,262	19,893	26,523	33,154	39,784	53,045	66,307	132,612	331,529
36	*3,729	7,457	14,912	22,368	29,823	37,279	44,734	59,645	74,557	149,112	372,779

* Consider using bottles for purges.



**Company Operations Standard
Gas Standard
Gas Engineering**

Purging Pipelines and Components	SCG:	182.0160
---	-------------	-----------------

NOTE: Do not alter or add any content from this page down; the following content is automatically generated.
Brief: Added verbiage referencing Distribution abandonment standard 184.0080 - Abandonment of Gas Services and Gas Light Tap Assemblies & 184.0085 - Abandonment or Inactivation of Gas Distribution Pipelines.

Document Profile Summary	
Responsible Person:	
Published On:	11/14/2016
Last Full Review Completed On:	12/16/2014
Writer:	
Document Status:	Active
Document Type:	GAS
Category (Prior FCD system only):	
If Merged, Merged To Document Number:	
Utility:	SoCalGas
Department:	Engineering Design
Number of Common Document (if applicable):	G7909
Contains OPQUAL Covered Task:	Yes
Part of SoCalGas O&M Plan:	Yes
Part of SDG&E O&M Plan:	No
Last O&M Review date:	2017-09-18
O&M 49 CFR Codes & Impacted Sections of Document:	192.751(a): 1.13 192.727(e): Entire Doc 192.727(c): Entire Doc 192.727(b): Entire Doc 192.629(b): Entire Doc 192.629(a): Entire Doc 192.605(b)(6): Entire Doc 192.605(b)(5): Entire Doc
Part of Non-O&M Parts 191-193 Plan	No
Non-O&M 49 CFR Codes & Impacted Sections of Document	
Part of Distribution IMP (DIMP)	No
Part of Transmission IMP (TIMP)	No
Part of Storage IMP (SIMP)	No
Impacts GO112F	No
GO112F Codes & Impacted Sections of Document	
Impacts GO58A	No
GO58A Codes & Impacted Sections of Document	
Impacts GO58B	No
GO58B Codes & Impacted Sections of Document	
Indices/Binders in Which Document is Filed:	TRAN, STOR, PCF, PC, MR, MS, DISTM, CM, CF
NOP Learning Module (LM) Training Code:	NOP00250



**Company Operations Standard
Gas Standard
Project Management & Construction**

Construction Planning for Mains and Supply Lines	SCG:	184.0015
---	-------------	-----------------

PURPOSE To provide guidelines and requirements for construction planning of Distribution mains, supply lines, and related service installations.

1. POLICY AND SCOPE

1.1. The Company provides guidance and instruction to properly plan the installation of Distribution natural gas facilities.

2. RESPONSIBILITIES AND QUALIFICATIONS

2.1. Gas Operations is responsible for the content and administration of this Gas Standard.

2.2. The Regions are responsible for implementation of, and adherence to, this Standard.

2.3. Only personnel qualified through Field Operations Training or Welding Training may perform these operations. See [STANDARD 167.0100](#), *Operator Qualification Program* and [STANDARD 184.0590](#) *Pressure Control Qualification Requirements*.

2.4. Field employees are responsible for adhering to Company procedures and shall wear appropriate personal safety equipment during any and all duties performed. See *Injury and Illness Prevention Program Binder* under [MANUAL IIPP.4](#), *Employee's Responsibilities*.

3. DEFINITIONS

3.1. Not applicable.

4. PROCEDURE

4.1. Items typically provided by the Planning and Engineering office include;

4.1.1. Job "package" envelope, tract map, plot plan, grading plan, etc.

4.1.2. Print of proposed work order sketch / base sketch or other map of the job location suitable for field preparation of the "planner's sketch." See [Standard 192.0005](#) *Preparation of Work Order / Base Sketch*. Figure 1 below demonstrates a sample base sketch drawing using GIS data.



**Company Operations Standard
Gas Standard
Project Management & Construction**

Construction Planning for Mains and Supply Lines	SCG:	184.0015
---	-------------	-----------------

Figure 1

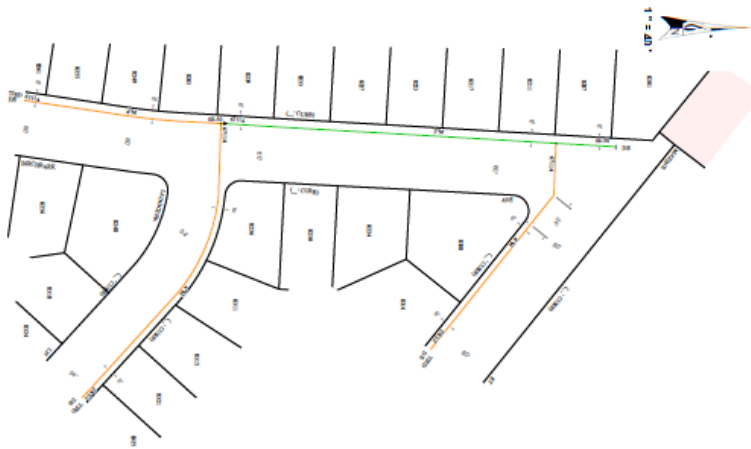

- 4.1.3. Strip map (reproduction of a Company atlas), denoting the limits of the proposed installation or replacement.
- 4.1.4. All substructure data available including proposed utilities if known
- 4.1.5. For replacement work, include archive copies of the original completion sketches (As-Built) for all existing facilities involved if available.
- 4.1.6. Public and private improvement plans (if applicable).
- 4.1.7. Special permit requirements or depth requirements.
- 4.1.8. Proposed pipe size, kind and design level. Specify branch connections to be installed in header mains to provide for known future laterals.
- 4.1.9. Service list or plan and service history information.
- 4.1.10. Valve requirements. See [STANDARD 180.0085, Valve Usage and Selection Guide](#).
- 4.1.11. Main ties that affect an isolation area and the isolation area number.
- 4.1.12. Ties and dead ends for pipe to be installed and abandoned.



**Company Operations Standard
Gas Standard
Project Management & Construction**

Construction Planning for Mains and Supply Lines	SCG:	184.0015
---	-------------	-----------------

NOTE: The gas supply to the entire affected piping system must be reviewed to correctly identify the source(s) of gas related to the construction area. Ensure piping and gas supply is properly identified to assure a constant supply of gas to the area during and after construction.

- 4.2. Corrosion control requirements and the locations of Company and foreign impressed current anode systems and the facilities they protect.
 - 4.2.1. As much information as possible about paving and soil conditions.
- 4.3. Downstream filtration requirements see [STANDARD 184.0281](#), *Filtration Requirements for Regulator Stations*.
- 4.4. Field planning requirements include (site investigation and consideration):
 - 4.4.1. On site working conditions such as residential or industrial area, type and thickness of paving, if known, shoring requirements, traffic control needs, etc.
 - 4.4.2. Determine if excavating operations will take place within 500 feet of a school (K-12) or hospital requiring pre-construction notification to the facility(s) per Assembly Bill (AB) 1937.
 - 4.4.3. Locations of property lines and curbs.
 - 4.4.4. Foreign substructures.
 - 4.4.5. Locations of specified job terminals.
 - 4.4.6. Locations and depth requirements for main and related facilities
 - 4.4.7. Methods of installation.
 - 4.4.8. Special permit requirements.
 - 4.4.9. Pressure control and gas handling requirements. See **Standard 184.06**, *Gas-Handling and Pressure Control*.
 - 4.4.10. For steel pipe installation, determine the need for odorant “seasoning” of the line; see [Standard 189.002](#) *Odor Conditioning of New Steel Lines*.
 - 4.4.11. Cathodic protection requirements.
 - 4.4.12. Related service work.
 - 4.4.13. Material requirements.

Formatted: Font: Bold

Formatted: Font: Italic



**Company Operations Standard
Gas Standard
Project Management & Construction**

Construction Planning for Mains and Supply Lines	SCG:	184.0015
---	-------------	-----------------

- 4.4.14. Installation and abandonment footage.
- 4.4.15. Planning for subdivisions.
- 4.4.16. Construction marking requirements.
- 4.4.17. Written gas handling procedures. See **Standard 184.06, Gas-Handling and Pressure Control.**

Formatted: Font: Bold

Formatted: Font: Italic

4.5. Environmental

- 4.5.1. Consider proximity to environmental resources when planning the facility locations.
- 4.5.2. If the site is known to be in proximity to a sensitive resource, an environmental review must be conducted by a Field Environmental Representative (FER) or Environmental Services (EPro).
 - 4.5.2.1. Document compliance with environmental pre-screening in the current construction management system and on the main package cover sheet.

4.6. Preparation of sketches by the project planner:

- 4.6.1. Prepare a rough sketch, also called a "Planner's Sketch", of the proposed field layout after field planning. Draw the sketch on a print of the work order / base sketch.
 - 4.6.1.1. A rough sketch may be drawn on a strip map, tract map, atlas sheet, or other suitable map of the job site and transferred to the work order sketch / base sketch prior to routing to the Planning and Engineering office.
 - 4.6.1.2. The Planner's Sketch will be used to create the Construction Sketch and it must contain all required information for that process. See [STANDARD 192.0010 Preparation of Construction Sketches](#).
- 4.6.2. Prepare the substructure sketch using information obtained from local municipalities and other utilities. (Utility member contact information can be obtained from underground service alert). Add any additional substructures found within the job limits during the on-site visit. See [STANDARD 192.0015 Preparation of Substructure Sketch](#).



**Company Operations Standard
Gas Standard
Project Management & Construction**

Construction Planning for Mains and Supply Lines	SCG:	184.0015
---	-------------	-----------------

- 4.6.2.1. Especially note surface structures when planning the route of the new pipeline, i.e. sewer manholes, telephone vaults, etc. The actual underground structure may be substantially larger than what is observed on the surface.

NOTE: A copy of Agency composite substructure map or improvement plans showing substructures are not an acceptable alternate to the substructure sketch.

- 4.6.3. Route Planners Sketch for approvals per [STANDARD 184.0014](#) *New Business Project Package Routing* and/or [STANDARD 184.0016](#) *Main Construction Project Package Routing*.

4.7. Planning and Engineering tasks include:

- 4.7.1. Distribution pipelines considered transmission lines as defined by [STANDARD 223.0415](#) *Pipeline and Related Definitions (Interpretation of 49 CFR 192.3)*, are evaluated to determine if the pipeline will be constructed in a High Consequence Area (HCA) per [STANDARD 192.02](#), *Operations Technology Procedure*.
- 4.7.1.1. [FORM 4262](#), *Request for Pipeline Assistance*, shall be used to document that a review has been performed to determine any impacts to transmission pipelines within HCA's. See [Standard 182.0010](#), *Request For Pipeline Design Assistance*.
- 4.7.2. Submit approved Planners Sketch for preparation of Construction Sketch. See [STANDARD 192.0010](#), *Preparation of Construction Sketches*.
- 4.7.3. Prepare a Request for Proposal (RFP) for those jobs that are considered for bid. See [STANDARD 103.0010](#), *Special Specifications – Request for Proposal (RFP) Process*.
- 4.7.4. For high pressure jobs enter all pipe, fittings and design information into the Design Data Sheet (DDS) Manager program to verify that all materials qualify for the design level and to determine strength testing requirements. See [STANDARD 182.0170](#) *Strength Testing Pipelines and Facilities*, and [FORM 3222](#), *Design Data Sheet (DDS)*.
- 4.7.5. When required, process a *New Steel Pipeline Information Form* to the EAC Project Manager to procure an odorization plan for the pipeline. See 189.002, *Odor Conditioning of New Steel Lines*.
- 4.7.6. Obtain Right of Way and Railroad Crossing Agreements, when applicable. See [STANDARD 106.0021](#), *Land and Right of Way Amendments*.



**Company Operations Standard
Gas Standard
Project Management & Construction**

Construction Planning for Mains and Supply Lines	SCG:	184.0015
---	-------------	-----------------

NOTE: The need for Right of Way or easements should be identified and the process started as soon as possible to prevent delays in the project.

4.7.7. Review permit requirements prior to releasing job package for special requirements that can be added to construction sketch.

5. OPERATOR QUALIFICATION COVERED TASKS
Not applicable.

6. RECORDS

6.1. The main job packages are to be retained per Company Records Retention Policy OPS-20-02, life of the asset plus five years (LOA+5).

7. APPENDICES
Not applicable.

DRAFT SB 1371



**Company Operations Standard
Gas Standard
Project Management & Construction**

Construction Planning for Mains and Supply Lines	SCG:	184.0015
---	-------------	-----------------

NOTE: Do not alter or add any content from this page down; the following content is automatically generated. Brief: Replaced Figure 1 with GWD based sample, changed references to suit new systems and programs (ex: CMS vs. CPD), various grammar and narrative changes not effecting the intent of the document.
--

Document Profile Summary	
Responsible Person:	
Published On:	08/26/2015
Last Full Review Completed On:	08/26/2015
Writer:	
Document Status:	Active
Document Type:	GAS
Category (Prior FCD system only):	
If Merged, Merged To Document Number:	
Utility:	SoCalGas
Department:	Project Management & Construction
Number of Common Document (if applicable):	
Contains OPQUAL Covered Task:	No
Part of SoCalGas O&M Plan:	No
Part of SDG&E O&M Plan:	No
Last O&M Review date:	
O&M 49 CFR Codes & Impacted Sections of Document:	
Part of Non-O&M Parts 191-193 Plan	No
Non-O&M 49 CFR Codes & Impacted Sections of Document	
Part of Distribution IMP (DIMP)	Yes
Part of Transmission IMP (TIMP)	Yes
Impacts GO112E	No
GO112E Codes & Impacted Sections of Document	
Impacts GO58A	No
GO58A Codes & Impacted Sections of Document	
Impacts GO58B	No
GO58B Codes & Impacted Sections of Document	
Indices/Binders in Which Document if Filed:	DIMP2, DISTM, TIMP2
NOP Learning Module (LM) Training Code:	NOP00291



Company Operations Standard Gas Standard Gas Operations & System Integrity

General Construction Requirements for Distribution Service Lines	SCG:	184.0060
---	-------------	-----------------

PURPOSE To provide guidelines and requirements applicable to distribution service installation, alterations and replacements for services operating at less than 20% SMYS.

1. POLICY AND SCOPE

- 1.1. Construction shall conform to permit requirements. See [STANDARD 191.0045](#), *Excavation Permits/Paving Repairs*.
- 1.2. Excavation shall be done in accordance with [STANDARD 184.0175](#), *Prevention of Damage to Subsurface Installations*, [STANDARD 184.0200](#), *Underground Service Alert and Temporary Marking* and [STANDARD 184.011](#), *Notification of Excavation and Construction Activities - Assembly Bill Number 1937/ PUC Code 955.5*.
- 1.3. Safety Procedures shall be followed when squeezing PE Pipe, refer to [STANDARD 184.0340](#), *Squeezing Polyethylene (PE) Pipe - 1/2" Through 8"* and [STANDARD 166.0025](#), *Prevention of Accidental Ignition of Natural Gas*.
- 1.4. Welding of steel pipe and joining (PE) pipe and fittings is only performed by trained and qualified company and contractor employees. See [STANDARD 187.0180](#), *Qualification and Re-Qualification of Welders* and [STANDARD 187.0181](#), *Qualification of Personnel - Polyethylene Pipe Joiners*.
- 1.5. Company employees and Contractor personnel must meet the minimum requirements for pressure control operations on the gas system. Refer to [STANDARD 184.0590](#), *Pressure Control Qualification Requirements*.
- 1.6. All sources of ignition shall be eliminated in the immediate vicinity while pressure control or gas handling operations are in progress. No open flame, electrical spark or welding is permitted. See [STANDARD 166.0025](#), *Prevention of Accidental Ignition of Natural Gas*.
- 1.7. Installing, altering or replacing a gas service, see [STANDARD 187.0146](#), *Excess Flow Valve (EFV) - Installation and Operation* and [STANDARD 182.005](#), *Service Pipe and Excess Flow Valve Sizing* for the requirements of installing an Excess Flow Valve.

Note: For customer requested Excess Flow Valves on existing services, refer to [STANDARD 187.0146](#), *Excess Flow Valve (EFV) - Installation and Operation* and [STANDARD 182.005](#), *Service Pipe and Excess Flow Valve Sizing*.

- 1.8. To determine if gas handling is necessary, see [STANDARD 184.06](#), *Gas Handling and Pressure Control*.



Company Operations Standard Gas Standard

Gas Operations & System Integrity

General Construction Requirements for Distribution Service Lines	SCG:	184.0060
---	-------------	-----------------

~~1.8.1.9.~~ To comply with inspection requirements contained in **§192.305** construction tasks required by *49 CFR, Part 192, subpart G*, and welding or fusion tasks that join pressure carrying pipe, specified in this Gas Standard shall be independently inspected. *“Personnel who performed the construction task requiring inspection shall not perform the inspection.”*

2. RESPONSIBILITIES AND QUALIFICATIONS

- 2.1. **Gas Operations Training** is responsible for ensuring the equipment and facilities used by an Operator for training and qualification of employees must be identical, or very similar in operation to the equipment and facilities which the employee will use, or on which the employee will perform the covered task.
- 2.2. **Districts** are responsible for compliance and implementations of this and other Gas Standards as it relates to distribution service lines.
- 2.3. **Gas Material - Gas Engineering** is responsible for administrating the development and coordinating the approval of material specifications that are used for distribution service lines.
- 2.4. Defective or leaking materials are sent to the **Engineering Analysis Center (EAC)** for Analysis. The EAC is responsible for analyzing material that is received from the Districts due to being defective or leaking. See section **4.7.3**.
- 2.5. To ensure safety and gas system integrity, only qualified personnel (**Company and Contractor**) shall perform pressure control operations on the gas system. See [STANDARD 184.0590, Pressure Control Qualification Requirements](#) and [STANDARD 167.0100, Operator Qualification Program](#)
- 2.6. **Employees** are responsible for adhering to company procedures and shall wear appropriate personal safety equipment during any and all duties performed. See Injury and Illness Prevention Program, [MANUAL IIPP.4, Employee's Responsibilities](#).
 - 2.6.1. Company provided coveralls, ear protection and safety goggles must be worn while performing all pressure control operations. Coverall sleeves must be down, buttoned, as well as, the neck buttoned. See Injury and Illness Prevention Program Binder under [MANUAL IIPP.4, Employee's Responsibilities](#).
- 2.7. **Field Employees** are responsible for ensuring that an approved fire extinguisher (minimum **40 BC**) is readily accessible and location known to all personnel at the work site. See [STANDARD 166.0025, Prevention of Accidental Ignition of Natural Gas](#).



Company Operations Standard Gas Standard Gas Operations & System Integrity

General Construction Requirements for Distribution Service Lines	SCG:	184.0060
---	-------------	-----------------

Note: **Field Employees** working in an aboveground, non-confined area (performing activities such as changing a stopcock) are required to have an approved dry chemical fire extinguisher of at least **20 BC** readily accessible upwind from their work.

2.8. When contractor personnel are working on pressurized gas lines, it is the responsibility of **Field Operations Supervisor** to ensure that contractor personnel are qualified to perform these operations.

2.8.1. **Contractors** are responsible for training their own employees in the operational guidelines related to pressure control tools and procedures specified in Company Gas Standards.

2.9. Under the Applicant Installation Program, contractors are not qualified for any phase of pressure control and shall not squeeze PE pipe.

3. DEFINITIONS

3.1. **Substructures** - (Subsurface Installations) any belowground pipeline, conduit, duct, casing, wire or any other structure.

3.2. **Encased** - Installation of carrier pipe into another pipe for use as described in [STANDARD 182.0148](#), *Casing Assemblies - Plastic Carrier Pipe*.

3.3. **Tools-Type Order:** Anytime an employee is required to use tools (i.e. pneumatic and or hand operated tools, impact bar) to install, replace or adjust fittings on the MSA (e.g., regulator change, leak orders, or anytime the service valve is turned on).

4. PROCEDURE

4.1. **Customer Communication**

4.1.1. When performing a construction activity or when working a tools type order on the customer's premises (including the area that a customer may be the caretaker of, such as the parkway), a company employee shall attempt to communicate to the customer what appropriate actions will be taken by the company. This includes, but is not limited to, explaining the type of work to be performed and any future follow-up actions, as well as any other information that will be pertinent to the customer.



Company Operations Standard Gas Standard

Gas Operations & System Integrity

General Construction Requirements for Distribution Service Lines	SCG:	184.0060
---	-------------	-----------------

4.1.1.1. If the customer is not present or not available when leaving the job site, leave [FORM 2001](#), *Customer Communications Tag - Distribution*. On [FORM 2001](#), check the appropriate box and/or write a brief explanation of the type of work that was performed and if a return visit will be required. Contact Dispatch and request a memo be added to the Customer’s Account with the type of work that was performed. The memo should also include any future follow-up actions, as well as any other information that will be pertinent to the customer.

Note: The attempt to communicate with a customer is intended for orders that have an actual dwelling address associated with the worked being performed.

4.1.2. Request supervision assistance the same day (or immediately if warranted) when a customer expresses concern regarding the work to be performed or is not satisfied with explanation given.

Note: Employee shall share with their supervisor all pertinent communications made between customer and employee.

4.2. Clearances and Location of Substructures

4.2.1. Notify Underground Service Alert (USA) as required per [STANDARD 184.0200](#), *Underground Service Alert and Temporary Marking* and non-member operators of underground facilities, two working days in advance.

4.2.2. Notify Transmission prior to any construction when transmission lines are to be crossed or exposed when installing new facilities.

4.2.3. Prior to mechanically boring or trenching, determine that all substructures have adequate clearance by hand exposing all known subsurface facilities. See [STANDARD 184.0175](#), *Prevention of Damage to Subsurface Installations* and [STANDARD 184.09](#), *Prevention of Excavation Damage to Company Facilities*.

4.2.3.1. When the excavation is proposed within ten (10) feet of a high priority subsurface installation, an onsite meeting involving the crew and the subsurface installation owner/operator’s representative shall be held to determine the action or activities required to verify the location of such installations before any excavation activity. See [STANDARD 184.0200](#), *Underground Service Alert and Temporary Marking*, Appendix A, 4216.2 (a) (2)).



**Company Operations Standard
Gas Standard
Gas Operations & System Integrity**

General Construction Requirements for Distribution Service Lines	SCG:	184.0060
---	-------------	-----------------

4.2.3.2. The entire area of the intended bore or excavation shall be checked by sweeping on an indirect and/or direct connection with a pipe locator to verify both known and identify any unknown subsurface installations. See [STANDARD 184.0170](#), *Trenchless Construction Methods*.

4.2.4. Independently installed gas pipelines (gas only), when independently installed, shall be separated, where practicable from electrical supply systems, water, oil, communication, or other pipe systems or other foreign substructures, by a clearance of at least 12 inches when paralleling and by at least 6 inches when crossing.

Note: New gas pipelines inserted within, and utilizing as conduit, pipeline facilities installed prior to the effective date of this rule (01/01/2017) are exempt from the paralleling requirements of this paragraph but not the requirements related to crossings

4.2.5. Concurrently installed (joint trench) gas pipelines, when concurrently installed with electrical supply systems, communication, other pipe systems, or other foreign substructures, shall be installed with the separation of 12 inches, except that by mutual agreement between all of the parties involved there may be less separation for duct systems for supply cables of 0 - 750 volts.

Note: Gas pipes shall be installed in joint trench with dry utilities only.

4.2.6. Special conditions such as hot oil lines may require even greater separation from the heat source. Contact Engineering & Technical Services for assistance regarding installations with unusual circumstances. Refer to [STANDARD 182.0010](#), *Request for Pipeline Design Assistance*.

4.2.7. In all instances where the required separations cannot be maintained, it is the responsibility of the party last installing facilities to confer with the utility and ensure that the reduced separations do not adversely impact the integrity of the gas pipeline facilities, which includes any cathodic protection that may be applied to the gas pipeline facilities.

4.2.8. All gas pipelines are to be installed with enough clearance from other substructures to allow for maintenance and to protect against damage that might result from proximity to other structures. For provided trench and joint trench specifications, see [STANDARD 184.001](#), *Field Planning of Main Construction Projects* and [STANDARD 184.010](#), *Planning Applicant Provided Trench Projects*.



Company Operations Standard Gas Standard

Gas Operations & System Integrity

General Construction Requirements for Distribution Service Lines	SCG:	184.0060
---	-------------	-----------------

4.3. Excavations

- 4.3.1. Pavement cuts, excavations, and bore slots are no larger than necessary for safe and proper pipe installation.
- 4.3.2. Undercutting of pavement is permitted only when authorized or requested by the City, County or State Inspector, and can be done safely.
- 4.3.3. Shore or slope excavations as required. See [STANDARD 223.0140, Excavating, Shoring and Sloping](#).
- 4.3.4. For direct burial excavations, attempt to excavate only that which is necessary so pipe is installed on undisturbed or well-compacted soil and material used for backfill must be free of materials that could damage the pipe or its coating.
- 4.3.5. When pipe is installed using open trench or trenchless construction, (while boring or jetting into place) exercise care to prevent damage to the pipe, tracer wire or pipe coating. See [STANDARD 184.0170, Trenchless Construction Methods](#) and [STANDARD 184.0235, Polyethylene \(PE\) Pipe Repair](#) for maximum allowable damage to polyethylene pipe, and [STANDARD 186.0110, Field Tape Wrapping Requirements](#)

4.4. Depth Requirements

- 4.4.1. Install all services to depth requirements of the permit issuing agency or the following, whichever is deeper.
 - 4.4.1.1. **Public Property** - Normal Installation:
 - 24 inches of cover below gutter flow lines.
 - 24 inches of cover below the lowest point of the roadway where no curbs or gutters exist.
 - 24 inches of cover between curb and property line unless subsurface installations necessitate less. PE services shall be encased in steel casing if minimum depth cannot be achieved.

Note: Measure service depth from proposed finished grade, rather than the existing, when street widening or other improvement is proposed and the new grade can be determined.

Note: Notify supervision when depth or other pertinent factors concerning knowledge of existing pipe may be compromised.

**Company Operations Standard
Gas Standard
Gas Operations & System Integrity**

General Construction Requirements for Distribution Service Lines	SCG:	184.0060
---	-------------	-----------------

4.4.2. All gas pipe installed in a navigable river, stream, or harbor must be installed with a minimum cover of 48 inches in soil or 24 inches in consolidated rock from the underwater natural bottom. Contact Engineering Design for approval.

4.4.2.1. **Private Property** - Normal Installation:

- Install all services operating above 60 PSIG, a minimum depth of 20 inches of cover below finished grade.
- Install steel services operating at or below 60 PSIG, a minimum depth of 12 inches of cover below finished grade. If field conditions warrant, provide a depth of sufficient cover to avoid the potential for damage.
- Install direct burial PE services a minimum depth of 20 inches of cover. 30 inches is recommended for machine excavation services.
- Install PE services in steel casing a minimum depth of 12 inches.
- Install PE services in plastic casing a minimum depth of 20" of cover; see [STANDARD 182.0148](#), *Casing Assemblies-Plastic Carrier Pipe*.
- Install new cross lot branch services a minimum depth of 30 inches of cover at the lot line to mitigate possible damage from future items such as grading and wall footing construction.

4.4.3. Shallow Service Installation

4.4.3.1. When subsurface installations make it necessary to install service at less than required depth in public property, write on the service order in the Excavation Section - "Request permit for shallow service". Attach a sketch to the order illustrating nature, size and depth of substructure; depth and length of gas service; and depth of gas main.

4.4.3.1.1. Encase or reinforce shallow services to protect services from any anticipated external load or potential damage.

4.5. **Source of Supply**

4.5.1. Use the closest gas main, when two or more are available, unless field conditions (traffic hazard, depth of main, medium pressure vs. high pressure, etc.) or economics (paving repair, etc.) dictate otherwise.

**Company Operations Standard
Gas Standard
Gas Operations & System Integrity**

General Construction Requirements for Distribution Service Lines	SCG:	184.0060
---	-------------	-----------------

4.5.2. Use "Branch Service" installation procedure when a standard or branch service is the source of supply. See [STANDARD 184.0033](#), *Branch Service Installations*.

4.5.3. Contact and obtain permission from Transmission if a transmission line is the only source of supply during the initial planning stage. See [STANDARD 182.0165](#), *Tap Requirements*.

4.6. Route of Service

4.6.1. Install the service along the most practical route, avoiding conflict with future construction. Whenever possible services should be installed in public property at right angles to the centerline of the street.

4.6.2. Do not cross lot lines with a standard service without written right-of-way authorization. See [STANDARD 106.0021](#), *Land and Right of Way Amendments*.

4.7. Material

4.7.1. Install only company approved pipe and fittings of adequate design and pressure rating. Refer to [STANDARD 180.0001](#), *Material Usage and Selection* for all services.

Note	The maximum allowable operating pressure for PE pipe is 60 PSIG.
-------------	--

4.7.2. Protect pipe and protective coating from damage while loading, transporting, unloading and installing.

4.7.3. Send all PE failures that can be cut out to the **Engineering Analysis Center, (SC723B)**, together with a copy of the completed [Form 4050](#), *Leak Repair Order* attached. Refer to [STANDARD 223.0030](#), *Investigation of Failures on Distribution and Transmission Pipeline Facilities* for the chain of custody.

4.8. Inspection, Aligning and Joining

4.8.1. PE Pipe.

4.8.1.1. Prior to installation of PE pipe, verify the manufacture date is in compliance with the 36 months allowable time frame from manufacture date.



Company Operations Standard Gas Standard

Gas Operations & System Integrity

General Construction Requirements for Distribution Service Lines	SCG:	184.0060
---	-------------	-----------------

Note: Polyethylene pipe not installed 36 months from the date of manufacture (marked on the pipe), shall be discarded and must not be used for gas carrying purposes.

Note: At the time of installation, Polyethylene pipe to be used above ground on a temporary bypass or temporary situation must not exceed 24 months from the date of manufacture. **The 24 months includes the duration of the temporary bypass or temporary situation from the date of manufacture.**

4.8.1.2. Inspect all PE pipe prior to installation. Cut out any kinks, dents, gouges, cuts or other imperfections which could affect the serviceability of the pipe. See [STANDARD 184.0235](#), *Polyethylene (PE) Pipe Repair*.

4.8.1.2.1. All (PE) pipe and fitting joints shall be visually inspected by the fuser. It is the Fuser's responsibility to cut out any defective fusions, and repeat the fusion process. Visual inspections of completed fusions must meet the Fusion Inspection Characteristics and Criteria for completed fusions identified in [STANDARD 187.0115](#), *Fusion Requirements for Polyethylene Pipe*.

4.8.1.3. Prevent foreign material from entering the pipe when storing, transporting, handling or installing.

4.8.1.3.1. All PE pipes must be capped, plugged or otherwise sealed until installed.

4.8.2. Steel Pipe

4.8.2.1. All welds shall be inspected in accordance with Company procedures.

4.8.2.2. Inspect steel pipe for protective coating damage and repair as necessary. See [STANDARD 186.0100](#), *Approved Protective Coatings for Below Ground Corrosion Control*.

4.8.3. All Pipe

4.8.3.1. Pipe ends must be clean and free from defects before any joining process is performed.



Company Operations Standard Gas Standard Gas Operations & System Integrity

General Construction Requirements for Distribution Service Lines	SCG:	184.0060
--	------	----------

- 4.8.3.2. Verify that inside of the pipe is free of debris and foreign material before joining it to another length of pipe.
- 4.8.3.3. Align pipe and fittings to avoid lateral strain or tension.
- 4.8.3.4. Inspect all pipes for visible defects before and during installation to ensure that it has not sustained any damage that could impair its serviceability.
- 4.8.3.5. The inspection shall be documented on [Form 2849](#), *Construction Inspection Report* (CIR) and the person/contractor employee who performed the construction task requiring inspection and the person who performed the independent inspection must be identified.

4.9. Pipe assembly

- 4.9.1. Weld all steel pipes in accordance with [STANDARD 187.0056](#), *Welding Field Guide* and [STANDARD 187.0055](#), *General Welding Requirements*.
 - 4.9.1.1. Always verify line pressure prior to welding on pressurized pipe.
- 4.9.2. Heat fuse or join all PE pipe connections in accordance with [STANDARD 187.0115](#), *Fusion Requirements for Polyethylene Pipe*.
 - 4.9.2.1. Electrofusion couplings shall be used in repairs and final tie-in situations where both pipe ends lack lateral in-line freedom of movement, see [STANDARD 184.0095](#), *Polyethylene (PE) Pipe and Fittings - General Installation Requirements* and [STANDARD 184.0235](#), *Polyethylene (PE) Pipe Repair*.
- 4.9.3. Verify size, type and location of gas main prior to installing service to main connections to prevent accidental tapping of casings or foreign substructure installations. See [STANDARD 187.0210](#), *Service-to-Main Connection (SMC)*.

4.10. Testing

- 4.10.1. All newly installed, repaired or reinstated piping shall be tested in accordance with [STANDARD 184.0150](#) *Leak Testing of Distribution Piping*.

4.11. Purging

- 4.11.1. After tapping service to main connection, purge service with gas to remove air and possible debris from piping.



Company Operations Standard Gas Standard Gas Operations & System Integrity

General Construction Requirements for Distribution Service Lines	SCG:	184.0060
---	-------------	-----------------

- 4.11.2. Vent gas away from buildings, equipment and any other possible sources of ignition, with the use of a purge bag (stock code **N654798**) or fittings. See [STANDARD 182.0160](#), *Purging Pipelines and Components*.
- 4.11.3. Ground Anodeless risers to prevent accidental ignition due to static electricity. See [STANDARD 166.0025](#), *Prevention of Accidental Ignition of Natural Gas*.
- 4.11.4. Service stubs 1 inch and smaller do not require purging.
- 4.12. **Backfilling and Compaction**
 - 4.12.1. Each service line must be properly supported on undisturbed or well compacted soil, and material used for backfill must be free of materials that could damage the pipe or its coating.
 - 4.12.1.1. Use backfill around the pipe that is free of rocks, building material, etc. that might cause damage to the pipe or its protective coating. Backfill material must comply with requirements of the permit issuing agency or responsible inspector. See [STANDARD 184.0002](#), *Site Restoration Specifications*.
 - 4.12.1.2. Soil must be compacted to comply with requirements of the permit issuing agency or responsible inspector. For hand backfilled and pneumatically compacted excavations, see [STANDARD 184.0055](#), *Hand Backfill and Compaction Method*.
 - 4.12.2. Each service line must be installed as to minimize anticipated piping strain and external loading.

4.13. **Installation of Belowground Services Under Buildings**

Note: Install belowground medium pressure services under buildings only when there is NO other alternative. Install services using the following provisions.

- 4.13.1. Encase the belowground service pipe that is to be installed under the building, and extend beyond building dimensions by 2 feet at open end of casing. Casing must meet standup test requirements. See [STANDARD 184.0150](#), *Leak Testing of Distribution Piping*.

Company Operations Standard Gas Standard Gas Operations & System Integrity

General Construction Requirements for Distribution Service Lines	SCG:	184.0060
---	-------------	-----------------

- 4.13.2. The space between the casing and service pipe is sealed with duxseal and plastic tape to prevent potential gas migration into the building if leakage occurred. Normally the riser end of the casing is sealed; leaving the opposite end open, see 4.13.1 of this standard. If the casing is sealed at both ends, install a vent line, extending from the casing to a point above ground where gas would not be a hazard. See [STANDARD 182.0080](#), *Casing Assemblies - Steel Carrier Pipe* and [STANDARD 182.0148](#), *Casing Assemblies - Plastic Carrier Pipe*.

CAUTION: Do not install belowground high-pressure services under buildings.

4.14. Installation of Services into Buildings

Note: Install medium pressure services within buildings only when there is **NO** other alternative. Install services using the following provisions.

- 4.14.1. The piping design and associated supports shall be reviewed and approved by Pipeline Design to ensure the design meets applicable codes including the California Building Code. This can be done by reviewing [STANDARD 182.0010](#), *Request for Pipeline Design Assistance*, and completed **FORM 4262**, *Pipeline Plan Review Request*.
- 4.14.2. When steel pipe is used for service piping that is to terminate within a building, a casing must be installed through the foundation wall and extend into the building to a normally usable and accessible part of the building. Seal the riser end of the casing with duxseal and plastic tape, and leave the opposite end of casing open to prevent leakage into the building. See 4.13.2 of this standard and [STANDARD 182.0080](#), *Casing Assemblies - Steel Carrier Pipe*.
- 4.14.3. When PE pipe is used for service piping that is to terminate within a building, steel pipe must be used for the portion that enters the structure, and must be cased and sealed as in Section 4.13 above. To protect the PE pipe from damage, a steel offset between the transition fitting and the building is recommended.
- 4.14.4. That portion of steel service located within an underground garage or basement must be rigidly secured but does not require encasement. Above ground piping must terminate at an approved meter location, and meet requirements for service valve installation. See [STANDARD 185.0001](#), *Meter Locations* and [STANDARD 184.0090](#), *Valve Selection and Installation – Services*.



Company Operations Standard Gas Standard Gas Operations & System Integrity

General Construction Requirements for Distribution Service Lines	SCG:	184.0060
---	-------------	-----------------

Note: Do not install high-pressure services (greater than 60 PSIG) within buildings.

4.15. Existing Services Under Buildings

4.15.1. When work is to be performed on a service and any portion of the uncased service is found belowground and under a building, that portion of the service must be altered or encased.

4.16. Drilling Foundations

4.16.1. To prevent cracking of foundation walls, holes must be drilled a minimum of 12 inches from any opening and no less than 4 inches from the top of the foundation.

4.17. Extending Beyond the Main

4.17.1. Do not extend service beyond the end of the main ("leading the main"), unless one of these situations exists:

- Future main extension is improbable or unnecessary because of physical barriers.
- Present facilities are adequate to serve any future customers.
- Installing a service diagonal to the main can eliminate a main extension of 50 feet or less. Distribution Technical Services must authorize these service routes after considering future growth potential.

4.18. Mobile Home Services

4.18.1. Use the following guidelines when planning new business services for mobile homes:

- Delay installation until the liquid waste disposal system, concrete patio or the carport slab is installed. Where practical do not install service piping under concrete slabs or paved driveways that directly abut the area designated for a mobile home coach.
- Obtain from the owner a plot plan of the property including location, dimensions of the coach in relation to the property line and the gas stub-out location and whether the mobile home is to be placed on a "foundation system" or not.
- Inform the owner that the stub-out locations shown on the plot plan are considered final, and that after service is installed, relocation is at owner's expense.

**Company Operations Standard
Gas Standard
Gas Operations & System Integrity**

General Construction Requirements for Distribution Service Lines	SCG:	184.0060
---	-------------	-----------------

4.19. Service Discrepancies

4.19.1. Installation crews are expected to meet deadline dates and avoid customer inconvenience. Contact supervision whenever the following service discrepancies arise:

- Meter location is unsatisfactory. See [STANDARD 185.0001](#), Meter Locations.
- When the method of installation or pipe footage is different than that which was planned and would result in higher cost to the company, a change order must be negotiated and signed by the customer.

4.20. Marking Service Locations on Curb

4.20.1. Chisel a "G" on the top of curb or sidewalk where service crosses the curb or sidewalk.

4.21. Service Converted to Main-Identification

4.21.1. Install two harness rings on the service shut off when a portion of the service is converted to main. (Example: main extension installed in parkway from an existing service to avoid cutting pavement.) See [STANDARD 223.0415](#), *Pipeline and Related Definitions*.

4.22. Cathodic Protection

4.22.1. When steel pipe is installed. Refer to [STANDARD 186.0002](#), *Design and Application of Cathodic Protection*.

4.22.2. For existing steel services that will be tied over to a PE main as the result of a main replacement. See [STANDARD 186.0005](#), *Cathodic Protection - Mixed Piping*.

4.23. Locating Wire Installation

4.23.1. Follow the guidelines for the installation of locating wire when installing or repairing polyethylene (PE) piping, see [STANDARD 184.0125](#), *Tracer Wire Installation for Polyethylene*.

Locating wire for polyethylene pipelines shall be conductively tested after new installations or repairs are completed to ensure system continuity.

**Company Operations Standard
Gas Standard
Gas Operations & System Integrity**

General Construction Requirements for Distribution Service Lines	SCG:	184.0060
---	-------------	-----------------

4.24. **Curb Meter Vaults**

Note: Discourage the installation of new business curb meter vaults and install only as a last resort after all other possible meter locations have been explored. The Project Manager must approve all meter and service regulator installations in curb meter vaults or other subsurface installations.

4.24.1. Install or extend all existing services in curb meter vaults to an acceptable above ground location agreed to by the property owner and the Company under the following conditions:

- Routine service replacements initiated by leakage.
- Service replacement and/or tie-overs involved in main replacements due to maintenance, franchise or street improvement projects.
- Repair of broken curb meter vaults or MSA parts.
- Pedestrian hazard, MSA leakage, regulator malfunction, pressure problems, chronic flooding problems or repeat call backs for service.
- Service alterations due to customer request or houseline leakage.

Note: All work performed due to customer's request is negotiated as per [STANDARD 191.0090](#), *D-Ticket - Collectible Work Agreements*.

4.25. **Material Traceability**

4.25.1. **For pipelines operating at greater than 60 PSIG**, refer to [STANDARD 182.0056](#), *Documentation Traceability of Pipeline Materials*.

- To ensure compliance with “Quality Practices” and “Rejection of Defective” Materials.
- For traceability when materials are altered or segmented in the field.
- To ensure material batch information traceability is captured during installation.

5. **EXCEPTION PROCEDURE**

(See [STANDARD 182.0004](#), *Exception Procedure for Company Operations Standards*).

5.1. An exception to this standard shall be considered only after practical solutions have been exhausted. Safety issues shall be given primary consideration, while adhering to governing codes before an approval of an exception is granted.



Company Operations Standard Gas Standard

Gas Operations & System Integrity

General Construction Requirements for Distribution Service Lines	SCG:	184.0060
---	-------------	-----------------

5.2. An exception from a standard shall not be allowed unless [STANDARD 182.0004](#), *Exception Procedure for Company Operations Standards* is followed and approval is given by the Responsible Person (RP) for the standard or by someone in that person’s organization that has been granted authority, and by others as required by 182.0004 and if specified in the standard from which the exception is requested.

6. OPERATOR QUALIFICATION COVERED TASKS

(See [STANDARD 167.0100](#), *Operator Qualification Program*, Appendix A, *Covered Task List*).

- **Task 01.01.** - 49 CFR 192.319 - Installing Transmission Pipelines and Distribution Pipelines in a Ditch.
- **Task 01.02.** - 49 CFR 192.327 - Maintaining minimum cover over pipelines.

7. RECORDS

7.1. All records will be noted and retained on appropriate work orders and As-Built drawing.

7.2. The *Construction Inspection Report*, [FORM 2849](#) shall be retained in the Field Audit Collection Tool (FACT) and a hardcopy in the work order file for the life of the pipeline plus five years.

7.3. Retain original documents in file per Records Management Retention Standards OPS-50-08. See Records Retention Standards on Sempra Net, <http://home.sempranet.com/rm/>.

7.4. Material Traceability

7.4.1. **For pipelines operating at greater than 60 PSIG**, refer to **STANDARD 192.0026** *High Pressure Project Reconciliation, Closeout and Turnover*.

- To ensure compliance with High Pressure Project Reconciliation Closeout and Turnover.
- For documentation and traceability.



Company Operations Standard Gas Standard Gas Operations & System Integrity

General Construction Requirements for Distribution Service Lines	SCG:	184.0060
---	-------------	-----------------

NOTE: Do not alter or add any content from this page down; the following content is automatically generated.

Brief: Conducted a functional review to re-establish 5-year review cycle. Reformatted to comply with document outline requirements. Purpose was revised to include services operating at less than 20% SMYS. Each section of the policy was updated for clarity. Added new requirement for Polyethylene PE pipe in section 4.8.1. Note, at the time of installation, Polyethylene pipe to be used above ground on a temporary bypass or temporary situation must not exceed 24 months from the date of manufacture. The 24 months includes the duration of the temporary bypass or temporary situation from the date of manufacture. Added Material Traceability to section 4.25 and 7.4. Updated Hyperlinks.

Document Profile Summary	
Responsible Person:	[REDACTED]
Published On:	11/14/2017
Last Full Review Completed On:	11/14/2017
Writer:	[REDACTED]
Document Status:	Active
Document Type:	GAS
Category (Prior FCD system only):	
If Merged, Merged To Document Number:	
Utility:	SoCalGas
Department:	Gas Operations & System Integrity
Number of Common Document (if applicable):	G7460
Contains OPQUAL Covered Task:	Yes
Part of SoCalGas O&M Plan:	No
Part of SDG&E O&M Plan:	No
Last O&M Review date:	
O&M 49 CFR Codes & Impacted Sections of Document:	
Part of Non-O&M Parts 191-193 Plan	Yes
Non-O&M 49 CFR Codes & Impacted Sections of Document	192.503(a): 4.10 192.375(b): 4.14 192.361(f): 4.13 192.361(e): 4.14, 4.22 192.361(d): 4.4, 4.12 192.361(b): 4.3, 4.12 192.361(a): 4.4 192.327(b)(c)(d)(e): 4.4 192.307: 4.8 192.305: 1, 4.2, 4.3, 4.4, 4.12, 7.2 192.303: Entire Document
Part of Distribution IMP (DIMP)	Yes
Part of Transmission IMP (TIMP)	No
Part of Storage IMP (SIMP)	No
Impacts GO112F	Yes
GO112F Codes & Impacted Sections of Document	142.1: 4.8 143.4: 2.1 144.3: (b)(1)4.2.4, (b)(2)4.2.5, (c)4.2.7
Impacts GO58A	No
GO58A Codes & Impacted Sections of Document	
Impacts GO58B	No
GO58B Codes & Impacted Sections of Document	
Indices/Binders in Which Document is Filed:	MS, DISTM, DIMP2, CM, CF, MKTG
NOP Learning Module (LM) Training Code:	NOP00304



Attachment H
Company Operations Standard
Gas Standard
Gas Operations

Field Procedure - Emergency Incidents Transmission	SCG:	183.0110
---	-------------	-----------------

PURPOSE The purpose of this Gas Standard is to describe the appropriate course of action for field employees responding to emergency incidents involving Company transmission pipelines and facilities.

POLICY AND SCOPE

- 1.1. The following actions are taken, as appropriate, by any Company personnel that are responding to a potential pipeline failure.
- 1.1.1. If Company personnel has confirmed that there is a Company pipeline failure, or believes there is a high probability that there is a Company pipeline failure, Company personnel shall take the following actions;
- 1.1.1.1. Immediately contact emergency response officials (fire/police) directly or have dispatch operations immediately contact emergency response officials.
- If calling from the same area in which the pipeline failure occurred, notify fire/police directly via 9-1-1.
 - If calling from a different area in which the pipeline incident occurred or if otherwise needed, utilize a direct-inbound ten-digit phone number, as listed in Company OEM documents [04.010-P](#), [04.010-OC](#), [04.010-I](#), [04.010-N](#), [04.020-P](#), [04.020-OC](#), [04.020-I](#), and [04.020-N](#) to ensure the call is routed to the appropriate local fire/police agency.
 - The company employee making the call should inform the agency of the possible or confirmed pipeline emergency and should ask the emergency official(s) if they received any other reported indicators such as natural gas odors, hissing, whistling or roaring noises, natural gas leaks, explosions, fires, etc.,

<p>NOTE: These reports may not have been linked to a possible pipeline incident and could help confirm the emergency and/or provide assistance to public safety personnel who may be responding to the scene.</p>
--

- 1.1.2. Notification of the incident to emergency response officials may take place prior to an actual field confirmation by a Company employee.
- 1.1.3. Several factors of varying importance in are considered when determining an appropriate course of action in emergency situations. Making this determination requires experience and the exercise of good judgment by those on the job, especially by those in charge of the job.

Field Procedure - Emergency Incidents Transmission	SCG:	183.0110
--	------	----------

1.1.3.1. **Public Safety** is of the greatest concern. Hazardous areas and buildings are evacuated and the public is restricted from them. Proper liaison with the fire and police departments is essential for the protection of the public.

1.1.3.2. **Employee Safety** is of major concern to the Company. As with normal work conditions, all work is performed with maximum regard for safety.

1.1.3.3. **Protection of property** is second only to the safety of the public and employees. It is essential that all sources of ignition be eliminated for the prevention of fires and explosions.

1.1.3.4. **Inconvenience to the public** - Good judgment involves weighing the effects of interrupting supplies to hospitals, schools, and similar institutions as well as taps serving distribution systems. Curtailment of interruptible customers involves considerable time to switch to standby fuels. Factors to consider when other things seem equal are: prolonged blowing of gas, noise in residential areas at night, blocking of streets, etc.

1.1.3.5. **Relative costs** are a factor but not sufficient reason to take undue risk of personal injury to employees and the public.

1.1.4. **Annual meetings** are held with **Transmission** and **Underground Storage field employees** and **supervisors** to review this procedure and other related instructions.

1.1.5. The Transmission Command Post is activated when warranted; see 01.010-T *Transmission command post guidelines*.

2. RESPONSIBILITIES AND QUALIFICATIONS

2.1. **Gas Transmission Operations** are responsible for compliance and implementations of this and other Gas Standards.

2.2. **Gas Engineering** is responsible for the contents of this Gas Standard and assists **Gas Transmission Operations** in determining root cause of the incident and assessing damage caused by the incident.

2.3. **Field employees** are responsible in adhering to company procedures and shall wear appropriate personal safety equipment during any and all duties performed. See Injury and Illness Prevention Program Binder under [Manual IIPP.4, Employee's Responsibilities](#).

Field Procedure - Emergency Incidents Transmission	SCG:	183.0110
---	-------------	-----------------

3. DEFINITIONS

- 3.1. **Emergency Incidents** - As it relates to this document, an unsafe condition involving, or suspected to involve, natural gas and customer or Company facilities or personnel. The incident may be a fire, damage to underground facilities, explosion, gas leak, injury, death, gas outage, district pressure problem, hazardous toxic material spills or other emergency incident as determined by the supervisor. Emergency incidents also include response requested by fire, police or other agencies.
- 3.2. **(MAOP)** - Maximum Allowable Operating Pressure.
- 3.3. **HCA** - High Consequence Area, as defined in [GS 192.02](#), *Operations Technology Procedure for HCA Segment Identification*.

4. PROCEDURE

Note: Gas Control shall be notified immediately regarding any incident involving a Gas Transmission pipeline or facility.

- 4.1. The following actions are taken, as appropriate, by the first Company employee at an emergency incident site involving **blowing gas** or a **hazardous material**, including Gas detected inside a building or a possibility of fire or explosion directly involving a pipeline facility.
- 4.1.1. Determine area limits and extent of the escaping gas, suspected Polychlorinated Biphenyl (PCB) contamination, Hydrogen Sulfide (H₂S) contamination or release of any other hazardous substance.
- 4.1.2. Determine if ignition or further contamination, or release of any other hazardous substance is a possibility.
- 4.1.3. Evacuate from and restrict entry into the hazardous area, particularly buildings, if the concentration of gas or the extent of contamination indicates ignition or health hazard is a possibility.
- 4.1.4. Establish communications with fire and/or police departments on the scene as soon as possible and confirm the extent of the emergency. If no emergency response agency is on scene and one is needed, notify fire/police directly via 9-1-1 or use a direct-inbound ten-digit phone number, as listed in Company OEM documents [04.010-P](#), [04.010-OC](#), [04.010-I](#), [04.010-N](#), [04.020-P](#), [04.020-OC](#), [04.020-I](#), and [04.020-N](#) to ensure the call is routed to the appropriate local fire/police agency. Initial communication should provide

Field Procedure - Emergency Incidents Transmission	SCG:	183.0110
---	-------------	-----------------

notification of the pipeline facility emergency and explain the extent of the emergency as known. Maintain communication as needed.

- 4.1.5. Coordinate plans to control the problem.
- 4.1.6. Eliminate sources of ignition.
- 4.1.7. Report the incident to a supervisor and request help as necessary.
- 4.1.8. All questions by news media are referred to highest ranking supervisor on the scene. If a supervisor is not available, advise media that a management representative will contact them as soon as possible.
- 4.1.9. The responsible supervisor reports the incident to the Message Center as appropriate. See [GS 183.05](#), *Reports to the Message Center*.
- 4.1.10. As applicable, the responsible operating organization investigates the incident to determine the cause and takes measures to prevent reoccurrence. See [GS 191.01](#), *Investigation of Accidents and Pipeline Failures*.
- 4.2. The following actions are taken by the Supervisor in addition to those steps identified in sections 4.1 if fire, explosion, or natural disaster, has occurred near a company facility (includes Distribution Systems).
 - 4.2.1. **Gas Control shall be notified immediately regarding any incident involving a Gas Transmission pipeline or facility.**
 - 4.2.2. Determine area limits and extent of all company facilities potentially involved.
 - 4.2.3. Evacuate from and restrict entry into the hazardous area, particularly buildings or structures that have suffered fire, earthquake or explosion damage or a concern with potential re-ignition of gas, fire or explosion.
 - 4.2.4. Contact Distribution if any of their facilities are within the potential impact radius of the incident. (Within 50 feet of fire, 100 - 200 feet from explosion or within 200 - 500 feet of earthquake damage).
 - 4.2.5. Contact the **Gas Engineering - Pipeline Design Team** for assistance in identifying potential concerns that should be investigated. For pipelines subjected to fire, if the coating of the piping or components has experienced discoloration or coating loss due to the heat from the fire, contact **Gas Engineering - Pipeline Design** to provide a more detailed evaluation.

Note: Heat from fire, gas burning along the ground, explosion, or damage caused by earthquake can potentially cause damage to underground or aboveground facilities away from the directly affected area.

- 4.3. The following actions are taken, as appropriate, by the first Company employee at a site (or at **Gas Control**) where it is known or suspected that transmission piping is or was pressurized beyond **110% of its maximum allowable operating pressure (MAOP)**.

Note: MAOP information is available in local maintenance records, in the Transmission Pipeline Summary, from **Gas Control** (in some instances), and in the Pipeline Database.

- 4.3.1. Take immediate steps to determine the cause of the overpressure and, if it can be done safely, make adjustments or repairs to bring the pressure back to the correct operating pressure.
- 4.3.2. To the extent possible, determine the details of the overpressure. Information gathered may include:
- The highest pressure reached,
 - How much pipeline was involved,
 - How long a time period the pipe was over pressured,
 - What equipment failed, if applicable, and
 - What immediate effects are known (leaks, ruptures), if any.
- 4.3.3. Report the incident to a supervisor and request help as necessary.
- 4.3.4. As soon as possible after the hazard is controlled, perform a patrol of the known or suspected over pressured pipeline segment to look for signs of leakage or a rupture. See [GS 223.0065](#), *Pipeline Patrol and Unstable Earth Inspections* and/or [GS 184.12](#), *Inspection of Pipelines on Bridges and Spans*.
- 4.3.5. As soon as practicable, perform an instrumented leakage survey of the known or suspected over pressured pipeline segment. See [GS 223.0100](#), *Leakage Surveys*.
- 4.3.6. The **responsible supervisor** reports the incident to the Message Center as appropriate. See [GS 183.05](#), *Reports to the Message Center*.
- 4.3.7. The **responsible operating organization** documents the details of the incident and the actions taken to resolve the incident. The report is filed in the permanent facility file. A copy of the report is sent to **Gas Engineering - Pipeline Design, and Gas Transmission Operations - Technical Services**.

Field Procedure - Emergency Incidents Transmission	SCG:	183.0110
--	------	----------

- 4.3.7.1. See [GS 223.0031](#), *Abnormal Operations - Transmission*, the requirements of that procedure must be met.
- 4.3.8. As applicable, the responsible operating organization investigates the incident to determine the cause and takes measures to prevent reoccurrence. See [GS 191.01](#), *Investigation of Accidents and Pipeline Failures*.
- 4.4. Pipeline Shutdown
- 4.4.1. **Emergency Shutdown or Emergency Pressure Reduction** related to “Emergency Incidents” as defined within this document (see section 3.1) - Notification shall be communicated to the appropriate first responders (fire Department) of an emergency shutdown or emergency pressure reduction on a system operating above 60 psig.
- 4.4.1.1. Notification Requirements refer to [GS 183.0112](#).
- 4.4.2. If a pipeline shutdown is considered necessary, Gas Operations is notified as required by [GS 223.0145](#), *Planning Shutdowns for Transmission and Storage*, prior to the shutdown.
- 4.5. Mutual Assistance
- 4.5.1. When the report or investigation reveals that the incident involves another **Transmission** facility (or a neighboring gas utility), it and **Gas Control** are notified immediately.
- 4.5.2. **Transmission** and **Underground Storage operations personnel** maintain continuing contact with personnel in the pertinent **Gas Operations Region** (and other gas utilities) so that exchange of information on mutual aid and notification is kept current.
- 4.5.3. When leakage or damage to **Gas Operations** facilities or other neighboring gas utilities is reported to or found by **Transmission** and **Storage Operations personnel**, take necessary initial action to provide for public safety and mitigate hazardous conditions until personnel from the **Gas Operations Region** or neighboring utility can assume responsibility for further control or repair measures. Appropriate action in a mutual aid situation is the same as that for a Company facility as described above.
- 4.5.4. After providing for public safety, gas control procedures may include:
- shut off meter
 - shut off, broken services
 - vent gas with bar holes



Company Operations Standard Gas Standard Gas Operations

Field Procedure - Emergency Incidents Transmission	SCG:	183.0110
--	------	----------

4.5.5. **Transmission and Underground Storage Operations** personnel do not operate mainline valves on **Gas Operations** or other companies' facilities without specific authorization from a **Supervisor** with operating jurisdiction.

4.5.6. Permanent repairs to facilities operated by a **Gas Operations Regions** are made only when specifically requested by a **Gas Operations Supervisor**.

4.6. Safety-Related Pipeline Conditions

4.6.1. If the hazardous condition is not corrected within 5 working days, a safety-related condition report is required.

See [GS 183.06](#), *Region Reports of Safety-Related Pipeline Conditions*.

5. OPERATOR QUALIFICATION COVERED TASKS

(See [STANDARD 167.0100](#), *Operator Qualification Program*, Appendix A, *Covered Task List*)

5.1. N/A

6. RECORDS

6.1. For pipelines that have been damaged due to fire exposure (refer to Section 4.2.4 of this standard), **Pipeline Design** shall prepare a report on the inspection of the fire damage using [Form 677-1](#), *Pipeline Condition and Maintenance Report*. The report shall be filed at the **Transmission District** where the damage occurred.

6.2. If the damaged pipe is a transmission pipeline (as defined by [GS 223.0415](#), *Pipeline and Related Definitions*) in an HCA, document any damage to the pipe including exposure to fire. **Pipeline Design** will prepare a damage report using [Form 677-1](#), *Pipeline Condition and Maintenance Report*, and send a copy of the report to **Pipeline Integrity**.

7. APPENDICES

N/A



Attachment H
Company Operations Standard
Gas Standard
Gas Operations

Field Procedure - Emergency Incidents Transmission	SCG:	183.0110
---	-------------	-----------------

NOTE: Do not alter or add any content from this page down; the following content is automatically generated.

Brief: Reformatted section 1 for clarity and added note, section 1.1.5 added section for activating Transmission Command Post, section 4.1.4 reformatted for clarity and added note, entire document updated Organizations and clerical corrections. Removed Reference for OPP Qual as it is N/A to this document.)

Document Profile Summary	
Responsible Person:	██████████
Published On:	04/26/2016
Last Full Review Completed On:	04/26/2016
Writer:	██████████
Document Status:	Active
Document Type:	GAS
Category (Prior FCD system only):	
If Merged, Merged To Document Number:	
Utility:	SoCalGas
Department:	Gas Transmission
Number of Common Document (if applicable):	
Contains OPQUAL Covered Task:	No
Part of SoCalGas O&M Plan:	Yes
Part of SDG&E O&M Plan:	No
Last O&M Review date:	2017-12-19
O&M 49 CFR Codes & Impacted Sections of Document:	192.615(a)(1): Entire Document 192.615(a)(2): 1.1.1, 4.1.4 192.615(a)(3): 1.1.1, 4 192.615(a)(4): 4 192.615(a)(5): 4.2.2 192.615(a)(6): 4.4 192.615(a)(7): 4.2.2 192.615(a)(8): 1.1.1, 4.1.4 192.617: 2.2, 4.1.10, 4.3.8
Part of Non-O&M Parts 191-193 Plan	No
Non-O&M 49 CFR Codes & Impacted Sections of Document	
Part of Distribution IMP (DIMP)	No
Part of Transmission IMP (TIMP)	Yes
Part of Storage IMP (SIMP)	No
Impacts GO112F	No
GO112F Codes & Impacted Sections of Document	
Impacts GO58A	No
GO58A Codes & Impacted Sections of Document	
Impacts GO58B	No
GO58B Codes & Impacted Sections of Document	
Indices/Binders in Which Document is Filed:	TRAN, TIMP2, STOR, EMGM
NOP Learning Module (LM) Training Code:	NOP00274



Company Operations Standard Gas Standard Gas Operations & System Integrity

Field Guidelines - Emergency Incident Distribution / Customer Service	SCG:	183.03
--	------	--------

PURPOSE To provide guidelines and requirements for Field Operations, (Distribution and Customer Service) activities related to emergency incidents.

1. POLICY AND SCOPE

- 1.1. To ensure public and employee safety, protection of property and prompt efficient control of the incident when conducting leak investigations and leak complaints received by the Company in order to properly classify and respond to appropriately.
- 1.2. When applicable, Company management personnel, shall refer to [GS 183.0105](#), *Incident Command System (ICS) for Emergency Incidents* for communication guidelines for inter-functional (i.e. transmission, distribution, etc.) cooperation and interagency (i.e. fire service, law enforcement, Caltrans, etc.) cooperation during an Emergency incident.

2. RESPONSIBILITIES AND QUALIFICATIONS

- 2.1. **Districts** shall provide immediate response to an emergency incident day or night.
- 2.2. **Hazardous leaks** require prompt action, immediate repair or continuous action until the conditions are no longer hazardous. Refer to [GS 223.0125](#), *Leakage Classification and Mitigation Schedules* for information on hazardous below and above ground gas leakage.

Note: A company employee finding hazardous leak indications must remain at the location performing activities to their ability and training to keep themselves, the public and the area safe until the appropriate support personnel has responded to isolate and correct the leak has arrived as per [GS 223.0125](#), *Leakage Classification and Mitigation Schedules*.

- 2.3. This document is reviewed annually with field employees or when significant revisions are made.
- 2.4. **Gas Operations Training** is responsible for ensuring the equipment and facilities used by an Operator for training and qualification of employees must be identical, or very similar in operation to the equipment and facilities which the employee will use, or on which the employee will perform the covered task.
- 2.5. **Districts** are responsible for being in compliance with this document.
- 2.6. **Field employees** are responsible for adhering to Company procedures and shall wear appropriate personal safety equipment during any and all duties performed. See Injury and Illness Prevention Program Binder under [MANUAL IIPP.4](#), *Employee's Responsibilities*.

**Company Operations Standard
Gas Standard
Gas Operations & System Integrity**

Field Guidelines - Emergency Incident Distribution / Customer Service	SCG:	183.03
--	-------------	---------------

- 2.7. **Gas Emergency Center** – (GEC) to provide operational support in an emergency.
3. DEFINITIONS
- 3.1. **Emergency incidents** - As it relates to this document, an unsafe condition involving, or suspected to involve, natural gas and customer or Company facilities or personnel. The incident may be a fire, damage to underground facilities, explosion, gas leak, injury, death, gas outage, district pressure problem, hazardous toxic material spills or other emergency incident as determined by the supervisor. Emergency incidents also include response requested by fire, police or other agencies.
- 3.2. **HCA** - High Consequence Area, as defined in [GS 192.02](#), *Procedure for HCA Segment Identification*.
- 3.3. **GEC** - Gas Emergency Center for the region.
- 3.4. **Hazardous Leak** – A Leak that represents an existing or probable hazard to persons or property.
4. PROCEDURE
- 4.1. **Factors in Determining Field Action**
- 4.1.1. Consider the following factors when determining the action to be taken:
- 4.1.1.1. **Public Safety** - Including, but not limited to, evacuating and restricting people from any hazardous area or buildings. Proper liaison with police and fire departments is essential.
- 4.1.1.2. **Employee Safety** - Perform all **Company** work with the maximum regard for safety.
- 4.1.1.3. **Protection of Property** - Second only to the safety of the public and employees.
- 4.1.1.4. **Inconvenience to Public** - Consider the effects of interruption of service to hospitals, schools and similar institutions; however, at no time is inconvenience given priority over public safety. Prolonged blowing of gas, noise at night in residential areas, blocking of street traffic, etc., are factors to be considered.
- 4.1.1.5. **Relative Costs** - Savings in costs is a factor; however, it is never sufficient reason to risk personnel and public injury.



**Company Operations Standard
Gas Standard
Gas Operations & System Integrity**

Field Guidelines - Emergency Incident Distribution / Customer Service	SCG:	183.03
--	-------------	---------------

4.2. Gas Leak Emergencies

- 4.2.1. The first qualified Company employee dispatched to the scene shall immediately conduct an on-site evaluation of the potential hazards to life and property resulting from escaping gas. If Company personnel has confirmed that there is a Company pipeline failure, or believes there is a high probability that there is a Company pipeline failure, Company personnel should immediately contact emergency response officials (fire/police) directly or have dispatch operations immediately contact emergency response officials. If calling from the same location in which the pipeline failure occurred, notify fire/police directly via 911. If calling from a different location from which the pipeline incident occurred or if otherwise needed, utilize a direct-inbound ten-digit phone number, as listed in Company OEM documents 04.010-P, 04.010-OC, 04.010-I, 04.010-N, 04.020-P, 04.020-OC, 04.020-I, and 04.020-N to ensure the call is routed to the appropriate local fire/ police agency. The company employee making the call should inform the agency of the pipeline emergency and should ask the emergency official(s) if they received any other reported indicators of a possible pipeline emergency such as natural gas odors, unexplained noises, natural gas leaks, explosions, fires, etc., as these reports may not have been linked to a possible pipeline incident and could help confirm the emergency and/or provide assistance to public safety personnel who may be responding to the scene. The findings shall be reported (this includes, but not limited to any significant action or control of escaping gas on the part of on-site personnel) to **Dispatch and management.**
- 4.2.2. **Requests Assistance** - When conditions warrant such action, immediately advise Dispatch of needed personnel and equipment. This includes but is not limited to notifying 911 emergency services if it is determined by the **Company representative** that the gas leak emergency incident may endanger life or cause serious bodily harm or damage to public and company property. See [GS 184.09](#), *Prevention of Damage to Company Facilities*.
- 4.2.3. **Establish communications** with fire and/or police departments on the scene as soon as possible. If no emergency response agency is on scene, notify fire/police directly as per section 4.2.1. Maintain communication as necessary. Initial communication should advise them of the indication of a pipeline facility emergency and seek to determine if they have information which may help confirm the emergency and/or to provide assistance to the public safety personnel who may be responding to the scene.

Company Operations Standard Gas Standard Gas Operations & System Integrity

Field Guidelines - Emergency Incident Distribution / Customer Service	SCG:	183.03
--	-------------	---------------

- 4.2.4. **Area Limits** - Determine the area limits where escaping gas is present as per [GS 184.0245](#), *Leak Investigation – Distribution* and [GS 223.0100](#), *Leakage Surveys*. Although gas from a leak or line break may appear to be venting safely to the atmosphere, it may also be migrating underground. Make a perimeter check to determine if gas is migrating into substructures or surrounding buildings, either through the ground or through the air. (Air intakes for commercial or home air conditioners are possible routes for gas to enter buildings.)

- 4.2.5. **Concentration of Gas** - Determine if the concentration of escaping gas is sufficient to make ignition a possibility, especially in or under structures, whether from underground migration or air movement. Check and monitor perimeters of the area of hazard to determine if gas is migrating into surrounding buildings. If a combustible gas indicator is not immediately available, a judgment decision should be made on the need to evacuate the area.

- 4.2.6. **Evacuation of People** - Evacuate and restrict people from any hazardous area, particularly buildings, if the concentration of gas indicates ignition is a possibility. Determine the need for rerouting or blocking of vehicular and pedestrian traffic.

- 4.2.7. **Sources of Ignition** - Eliminate and keep all sources of ignition from the restricted area. Close gas meters within the area and warn persons against operating electric switches, smoking, internal combustion engines, electric motors, etc.

Note: If working on a potentially flammable leak at night and lighting is required, use only Class 1 Division 1 (explosion proof) lighting.

- 4.2.8. When necessary, contact the local electric company for assistance in their service territory if any of the following conditions exist:
 - 4.2.8.1. An electrical service should be de-energized to a building or group of buildings to mitigate danger of explosion, fire, or other threats to public or employee safety.
 - 4.2.8.2. To prevent re-energizing of electrical service to a building or group of buildings until danger of explosion, fire or other threats to safety have passed.
 - 4.2.8.3. Damaged gas line is in joint trench with a local electrical line.

**Company Operations Standard
Gas Standard
Gas Operations & System Integrity**

Field Guidelines - Emergency Incident Distribution / Customer Service	SCG:	183.03
--	-------------	---------------

4.2.8.4. In a situation where there is a possibility that assistance by the local electric company may be required, but no immediate action is necessary.

Note: **Southern California Edison Company** provides service throughout various areas in Southern California. Contact phone numbers for Edison are provided in [Appendix A](#). The regions are responsible for maintaining phone numbers for individual local electric companies that operate in their service territories. Refer to the Local Instruction section of the Operations Emergency Manual (OEM).

4.2.9. **Report to Dispatch** - Report all pertinent information to the **Dispatch Office** as soon as the situation permits.

4.2.9.1. Identify any information which may involve conjecture. In addition, determine and report:

- Cause of damage.
- Contractor/Company & type of equipment used.
- Size, type and pressure of line, if known.
- Approximate depth of facility.
- Any known injuries.
- Damage to company property.
- Damage to other property as a result of the line break.
- Need for Fire Department, Police Department, etc.
- Any special crew requirements.
- Was company pipeline marked out? Correctly?
- In case of MSA, were there barricades?

4.2.9.2. Request Dispatch to obtain help from fire, police and/or additional Company personnel, if needed. See [GS 183.05](#), *Message Center Reporting*, for reporting criteria, procedures and responsibilities for reportable incidents.

4.2.10. **Police and Fire Departments** - Establish and maintain contact with police and/or fire personnel on scene. Explain situation and plan for control of the area and give and/or ask for assistance. Exchange contact information and as established, confirm on site command post locations.



**Company Operations Standard
Gas Standard
Gas Operations & System Integrity**

Field Guidelines - Emergency Incident Distribution / Customer Service	SCG:	183.03
---	------	--------

- 4.2.11. **News Media** - Refer questions by news media to the supervisor on the scene. If a supervisor has not arrived, advise news media that a management representative will contact them as soon as possible.
- 4.2.12. **Gas Migration** - Check and monitor perimeters of the area of hazard to determine if gas is migrating into surrounding buildings.
- 4.2.13. **Maintains Surveillance** - Continue to maintain surveillance of uncontrolled escaping gas using an approved combustible gas detector to minimize the potential hazard to the general public until assistance arrives. Continually monitor and review the situation to insure it does not escalate to a greater hazard. Keep Dispatch informed of conditions.
- 4.2.14. **Excavation Notification** – If an excavation is immediately required to mitigate the emergency, notify Underground Service Alert during normal business hours (see [GS 184.0200](#), *Underground Service Alert and Temporary Marking*). If the emergency occurs after business hours and requires excavation, request for Dispatch to directly contact local utilities such as telecommunications, electric, water, petroleum, etc. to inform the utilities about the excavation. Look for signs of high priority facilities before excavating, such as pipeline markers from petroleum companies (Kinder Morgan, Chevron, Shell, Crimson, etc.) or electric high voltage signs. Contact the telephone number displayed on the marker before beginning excavation.

Note: Some utilities may not respond to mark their facilities after normal work hours. A positive response by the utility is not required to conduct emergency excavation.

4.3. **Emergency Procedures - Response Crew**

- 4.3.1. The response crew upon arrival at the scene shall immediately assess the potential hazards of the escaping gas. The response crew *leader* shall review the status of the incident with the **responsible Company employee** on the scene or perform the action and evaluation procedures specified under section 2. Precautions are taken as outlined in [GS 166.0025](#), *Prevention of Accidental Ignition of Natural Gas*.

Note: Minimum personal protective equipment requirements must be met whenever working in an environment involved with leaking gas. Cotton coveralls with sleeves rolled down and cuffs/ pants secured, along with gloves and goggles/safety glasses must be worn.

**Company Operations Standard
Gas Standard
Gas Operations & System Integrity**

Field Guidelines - Emergency Incident Distribution / Customer Service	SCG:	183.03
--	-------------	---------------

4.3.2. The response crew shall proceed with the safest method available *given the factors and conditions of the damage location* to control the escape of gas. Various methods for control of the gas may be used. Consideration shall be given in the following order:

4.3.2.1. Valves may be available on a piping system to control the escape of gas. Valves shall not be operated until their use is verified and approved by regional planning personnel.

4.3.2.2. Consideration shall be given to the use of remote/weld holes to control the escape of gas and keep personnel clear of a potentially hazardous atmosphere. When applying this method to gain control of the leaking gas, the remote hole(s) must be periodically monitored using an approved combustible indicator (CGI) to verify that no gas is migrating from the leak into the remote/weld hole. If gas indications are noted and they reach a level of greater than 2.7% (in the area that work will be performed), appropriate respiratory protective equipment and Gas Extraction Suit™ are required in the remote/weld hole. See [GS 166.0076](#), *Working in Flammable Atmospheres*.

4.3.2.3. Control of gas at the point of discharge is to be performed by **trained and qualified personnel only**, using appropriate respiratory protective equipment and Gas Extraction Suit™ with all required personal protective equipment and under the following conditions:

4.3.2.3.1 The gas is blowing freely into the atmosphere, the work can be performed safely and the escaping gas can safely be controlled with approved tools and equipment. This equipment may include the “halt” emergency shut-off device, clamps, redwood plugs, various approved steel squeezing devices, various approved plastic squeezing devices, etc.

Note: Special precautions must be taken when working around blowing gas on a plastic facility. See [GS 166.0025](#), *Prevention of Accidental Ignition of Natural Gas*.

4.3.2.4. Prior to using engine-operated equipment to excavate around or near blowing gas, and to prevent ignition by an engine spark, an approved combustible gas indicator (CGI) must be used to ascertain that no concentration of gas is blowing or migrating up and under the equipment. The atmosphere must be continually monitored. If an atmosphere free of gas cannot be verified or maintained and changing wind conditions create a potential hazard of ignition, the equipment must not be used.

**Company Operations Standard
Gas Standard
Gas Operations & System Integrity**

Field Guidelines - Emergency Incident Distribution / Customer Service	SCG:	183.03
--	-------------	---------------

4.3.3. **Recheck of Area** – After the escaping gas is controlled, recheck the restricted area with an approved combustible gas indicator (CGI) for additional leakage, residual accumulations of gas in street openings, sewers, and drains in, under and around buildings before removing restrictions. See [GS 184.0245](#), *Leakage Investigation – Distribution*. Take appropriate action to clear residual gas from aboveground and belowground structures.

4.3.3.1. When interagency involvement (i.e. fire service, law enforcement), update department command on status of incident as appropriately.

4.3.3.2. The response crew shall give special consideration to any possible secondary pipeline system damage and resulting leakage underground such as a service which might be pulled out of the main some distance away, etc. Conduct a bar hole survey back towards the source of gas to locate and eliminate the possibility of secondary underground leakage. Gas leakage underground and subsequent migration can represent the greatest potential hazard to the safety of the public.

4.3.3.3. A layout of the gas system piping should be obtained to expedite surveillance of piping in the area for other possible sources of leakage.

4.3.4. **Repair Reports** - The leak repair report on the incident shall include all information pertaining to the repair, any special leak surveillance performed by the response crew, on-scene arrival time, and the times at which major control actions were performed.

4.3.5. **Permanent Repairs** - Permanent repairs shall be made as soon as possible. Initiate normal procedures to permanently repair leaks and restore service when the situation is under control.

4.4. **Seismic Activity**

4.4.1. District Supervision in conjunction with Technical Services is responsible for monitoring seismic activity within their respective areas, and determines when such activity is considered to warrant further system evaluation.

4.4.2. The following steps may be considered when further system evaluation is warranted.

- Assessment within the affected area
 - Verify system pressures are within normal operating levels.
 - Special Patrols.



Company Operations Standard Gas Standard Gas Operations & System Integrity

Field Guidelines - Emergency Incident Distribution / Customer Service	SCG:	183.03
--	------	--------

- Special Leak Surveys. See [GS 223.0100](#), *Leakage Surveys*.
- Communication with local Emergency Response Agencies.
- Review Customer complaints for affected area.
- Review Regional/District emergency guidelines.
- Additional considerations identified in Section 4.5.

Note: For the latest information concerning recent Earthquake activity for California and Nevada, the following reference may be used:

<http://earthquake.usgs.gov/earthquakes/>

- 4.5. **Severe Damage Resulting from Natural Causes, Accidents or Sabotage**
- 4.5.1. If it is apparent, or suspected, that severe damage has occurred to the gas mains and/or services, it is the responsibility of the **Region** to promptly assess the general extent of the damage and immediately shut off the gas supply where a hazard to life or property exists.
- 4.5.2. The gas supply is not restored until leaks and breaks in mains and services are repaired, isolated or until it has been determined that mains can be re-pressured on a controlled basis.
- 4.5.3. It is important to keep the **Message Center** informed of the conditions of the system and the action taken during an emergency. It is mandatory to make progress reports as additional information is available or as new developments occur. Once the incident stabilizes and emergency work is completed, report updates to the **Message Center** at a minimum of every two hours until the **Message Center Report** is closed.
- 4.6. **Emergency Shutdown, Pressure Reduction or Overpressure**
- 4.6.1. In response to meet the requirements contained in California Public Utility Code, section 956, **Emergency Shutdown and Pressure Reduction** related to “**Emergency Incidents**” as defined within this document (see section 3.1) - Notification shall be communicated to the appropriate first responders (fire Department) of an emergency shutdown or emergency pressure reduction on a system operating above 60 PSIG.
- 4.6.1.1. Document on the work order that notification was made.
- 4.6.1.2. Situations where an EIR (Emergency Incident Report) has been opened, verify with dispatch that notification to the appropriate first responders have been made and ensure that the notification is documented in the EIR.

**Company Operations Standard
Gas Standard
Gas Operations & System Integrity**

Field Guidelines - Emergency Incident Distribution / Customer Service	SCG:	183.03
--	-------------	---------------

4.6.2. **Verification of Interruption or Overpressure** - An interruption of gas supply, or overpressure, is assumed to exist if alarms are called out by electronic pressure recorders or electronic pressure monitors or, if several customers within a related area report they have no gas, their pilots are out or the gas flames are high. Immediately dispatch personnel to check pressures at regulator stations and established terminals in the affected area.

4.6.2.1. Check pressures at feed points to determine if regulator outlet pressures can maintain proper supply at the extremities of the area. The required pressure varies according to the size of the network and the load in the area.

4.6.2.2. The pressures in the affected area are checked to determine the existence, and extent, of the overpressure or gas outage. If the pressures at feed points and established terminals are found to be proper, the overpressure or interruption to supply may be a local condition.

4.6.2.3. When pressure has significantly exceeded MAOP in a pressure area or customer meter set assembly, take appropriate remedial action. Remedial action may include, but is not limited to:

4.6.2.3.1. Take pressure area readings to determine geographical extent of the overpressure and whether the amount of overpressure may indicate other action is necessary.

4.6.2.3.2. Check with **Dispatch** for reports of high flames at appliances or aldehyde odors.

4.6.2.3.3. A special leakage survey may be warranted. Refer to the leakage history/condition of the affected area to help determine the extent of the survey. See [GS 223.0100](#), *Leakage Surveys*.

4.6.2.4. Check regulators in the affected area. Domestic non-overpressure protection regulators must be changed out after being subjected to 125 PSIG. Check manufacturer's literature to determine emergency inlet rating for other regulators.

4.6.2.5. Check meter set assemblies for leakage and pressure correctors for accuracy. See [GS 142.02](#), *Leak Investigation – Customer Service* and [GS 190.0030](#), *Pressure and Temperature Factors for Gas Volume Determination*.



Company Operations Standard Gas Standard Gas Operations & System Integrity

Field Guidelines - Emergency Incident Distribution / Customer Service	SCG:	183.03
--	------	--------

- 4.6.2.6. Certain over-pressure and under-pressure conditions require immediate notification to the CPUC. See “**Reportable Gas Incidents to CPUC and PHMSA**” Section 4.10 for details.
 - 4.6.2.7. If further investigation is warranted to determine if the cause was a result of regulation station failure or malfunction, contact the Region Measurement & Regulation department for assistance.
 - 4.6.3. **Shutdown of Area** - Give consideration to possible hazards versus the inconvenience to the customers when supply to the area is shut down. See [GS 183.01](#), *Shutdown Procedures and Isolation Area Establishment for Distribution Pipeline Facilities*.
 - 4.6.4. **Restoration of Gas Supply in Mains.**
 - 4.6.4.1. Gas shall be restored to an area, only after **Field Services** has reported that the service valve to each meter set in the affected area is closed and all risers have been observed for Abnormal Operating Conditions (AOCs).
 - 4.6.4.1.1 Service valves and risers found damaged, shall be repaired or replaced.
 - 4.6.4.1.2 Service risers not accessible/observed for AOCs or valves not closed as per **section 4.6.4.1** must be temporarily disconnected and restored as per the note below.
 - 4.6.4.2. Gas supply to pipelines may be restored by gradually increasing pressure to the normal operating level, while purging at the furthest ends of the main in the affected area to ensure the system is operating at 100% natural gas in accordance with [GS 182.0160](#), *Purging Pipelines and Components*.
 - 4.6.4.2.1 A leak survey shall be performed over the entire system, including services and branch services to ensure safe operation of the restored area.
 - 4.6.4.2.1.1. Leakage found on pipelines shall be coded and repaired per [GS 223.0125](#), *Leakage Classification and Mitigation Schedules*.
- Note:** If a service line is required to be temporary disconnected from the main or repaired during the shutdown, a leak/standup test of the service line must be performed in accordance with [GS 184.0150](#), *Leak Testing of Distribution Piping* for testing procedures prior to restoring.



Company Operations Standard Gas Standard Gas Operations & System Integrity

Field Guidelines - Emergency Incident Distribution / Customer Service	SCG:	183.03
--	------	--------

4.6.4.3. **Area Managers** are responsible for directing the restoration of gas supplies in distribution facilities for major outages. Every practical and safe means is used to restore the gas supply at the earliest possible time.

4.7. Fires or Explosions

- 4.7.1. The **field employee** dispatched to the scene contacts the fire department official in charge (when conditions permit) in order to determine that gas service to the affected structure is closed, if necessary. Full cooperation is extended to public officials who request information or assistance in determining cause.
- 4.7.2. A meter clock test and a pressure test are required whenever damage or injury is claimed or suspected to be the result of gas leakage or there has been a fire or explosion within the premises or structure. Do not attempt to make such tests until fire officials deem it safe to do so.
- 4.7.3. A further test may be required to determine if underground leakage exists. Whenever isolated sections of underground main or service piping are to be pressure tested in relation to emergency incidents, they must first be tested at existing line pressure. A higher-pressure test may compromise the integrity of the piping system by creating conditions that did not exist prior to the incident. Once the existing line pressure test has been made, and repairs, if necessary, are completed, refer to [GS 184.0150](#), *Leak Testing of Distribution Piping* for testing procedures prior to restoring isolated sections to active service.
- 4.7.4. All risers must be inspected to see if they have been subjected to Excessive Heat Exposure. This exposure can be, but is not limited to, smoke or burn damage to: vegetation, fences, walls, and structures, wrap, locating wire, meter indexes or MSA part. If any service terminating with either an Anodeless Riser or a No Stress/Service Head Adaptor shows this type of exposure, it must be replaced.

Note: Anytime routine work is performed on a riser or MSA (such as: turn-ons, closes, no gas, investigations of disconnected or missing meters, MSA rebuilds, service restorations, leak surveys or other miscellaneous maintenance or inspection orders) and possible smoke or burn damage is suspected, the preceding steps must be followed. A pressure test may be required. The type of riser must be accurately identified and all Anodeless Risers or Service Head Adaptors must be replaced regardless of whether they are currently leaking or not.

**Company Operations Standard
Gas Standard
Gas Operations & System Integrity**

Field Guidelines - Emergency Incident Distribution / Customer Service	SCG:	183.03
---	------	--------

4.7.5. For pipeline failures caused by fire damage, if the coating of the piping or components has experienced discoloration or coating loss due to the heat from the fire, contact **Gas Engineering - Material and Equipment Group** to conduct an evaluation, see [GS 191.01](#), *Investigation of Accidents and Pipeline Failures*.

4.8. Discharge of Pipeline Liquids

4.8.1. In the event pipeline liquids are released to the atmosphere and Polychlorinated Biphenyls (PCBs) are suspected, it is important that this information be reported immediately to **Message Center**. Consider all liquids hazardous.

4.8.2. A **supervisor** at the scene arranges to notify **Message Center**. Information includes the location (residential, commercial or rural) and the extent of liquid sprayed on people, buildings, vehicles, etc., see [GS 104.02](#), *Notification Requirements for Release/Spill Events*.

4.8.3. A **supervisor** on the scene remains available for additional follow-up contact. For additional information on clean up instructions, refer to [GS 104.0085](#), *PCB Spill Clean-up and Decontamination*.

4.9. Inter-Region Mutual Assistance

Notify the **Transmission (ETS) Operating Organization** (or other company) when the report or investigation reveals that their facilities are involved. Dispatch appropriate **Distribution Field Operations personnel** immediately when the report does not definitely pinpoint whose facilities are involved or when requested by the **Transmission Operating Organization**.

4.9.1. **Action by Field Personnel - Field personnel** take action to control hazards. Such action may include, but is not limited to, shutting off gas meters in immediate vicinity; evacuation of buildings and control of traffic; shutoff, squeezing or plugging of broken services and venting of gas with bar holes. Main valves are not operated except when instructions are received from a **responsible supervisor** of the affected **Operating Organization**.

4.9.1.1. **Dispatch of Crews and Equipment – Distribution crews** and equipment are dispatched to incidents involving a **Transmission Operating Organization’s** facility when requested because of distance or availability of material or equipment. The **Distribution crew** proceeds with repair work under **Transmission supervision** if warranted by existing conditions and requested by a **supervisor** of the **Transmission Operating Organization**.

Company Operations Standard Gas Standard Gas Operations & System Integrity

Field Guidelines - Emergency Incident Distribution / Customer Service	SCG:	183.03
---	------	--------

4.9.2. **Liaison with Transmission (ETS) — Distribution personnel** maintain continuing contact with pertinent **Transmission Operating Organization** to exchange information on mutual aid and to keep notification procedures current.

4.10. Reportable Gas Incidents to CPUC and PHMSA

4.10.1. For comprehensive details on these and other CPUC and PHMSA reporting requirements, see [GS 183.07](#), *Pipeline Incident Reports to CPUC and PHMSA; National Transportation Safety Board (NTSB) Accident Investigation*.

4.11. Material Traceability

4.11.1. For materials used during an emergency incident on pipelines operating at greater than 60 PSIG, refer to [GS 183.0130](#), *Materials and Supplies for Emergency Situations*.

- To ensure batched and non-batched managed material information is captured during installation.
- To define data capture roles/ responsibilities for HP PVFE material consumed during an emergency situation.

5. EXCEPTION PROCEDURE

(See [GS 182.0004](#), *Exception Procedure for Company Operations Standards*)

5.1. An exception to this standard shall be considered only after practical solutions have been exhausted. Safety issues shall be given primary consideration, while adhering to governing codes before an approval of an exception is granted.

5.2. An exception from a standard shall not be allowed unless [GS 182.0004](#), *Exception Procedure for Company Operations Standards* is followed and approval is given by the Responsible Person (RP) for the standard or by someone in that person's organization that has been granted authority, and by others as required by 182.0004, and if specified in the standard from which the exception is requested.

6. OPERATOR QUALIFICATION COVERED TASKS

(See [GS 167.0100](#), *Operator Qualification Program, Appendix A, Covered Task List*).

Not Applicable.

7. RECORDS

7.1. Records of annual review of this document are documented and retained in the Region file for 3 years.



Company Operations Standard Gas Standard Gas Operations & System Integrity

Field Guidelines - Emergency Incident Distribution / Customer Service	SCG:	183.03
--	------	--------

- 7.2. **Region** shall maintain records of the following pipeline forms:
 - 7.2.1. **Form 4050** *Leak Investigation Order* using “Click Mobile” completed and electronically filed in SAP.
 - 7.2.2. **Form 677-1** Pipeline Condition and Maintenance Report.
- 7.3. For pipelines that have been damaged due to fire exposure (refer to Section 4.7.5 of this standard), **Gas Engineering-Material and Equipment Group** shall prepare a report on the inspection of the fire damage using **Form 677-1, Pipeline Condition and Maintenance Report**. The report shall be filed at the **Transmission, Storage or Distribution Region** where the damage occurred.
- 7.4. If the damaged pipe is a transmission pipeline (as defined by **GS 223.0415, Pipeline and Related Definitions**) in an HCA, for any damage to the pipe including exposure to fire, **Gas Engineering-Material and Equipment Group** will prepare a damage report using **Form 677-1, Pipeline Condition and Maintenance Report**, and send a copy of the report to **Pipeline Integrity**.

8. APPENDICES

8.1. APPENDIX A

Notification Procedure

Provide the following information:

- A. Name, telephone number, and company.
- B. The nature and severity of the emergency.
- C. Street address, cross streets, or geographical boundaries of the affected area including name of community and county.
- D. Action requested of local electric company.
- E. Anticipated duration of emergency.
- F. Contact name and telephone number for further communication and coordination.
- G. Name of job site contact for site coordination.



Company Operations Standard Gas Standard Gas Operations & System Integrity

Field Guidelines - Emergency Incident Distribution / Customer Service	SCG:	183.03
--	------	--------

Contact Southern California Edison Company at the following 24-hour numbers

- | | |
|---------------------------|------------------------|
| Los Angeles County | 800-962-6269 |
| Orange County | 800-962-6269 |
| Other counties as listed* | 800-426-0621 |
| *Fresno County | *Mono County |
| *Imperial County | *Riverside County |
| *Inyo county | *San Bernardino County |
| *Kern County | *Santa Barbara County |
| *Kings County | *Tulare County |
| *Madera County | *Tuolumne County |
| *Mariposa County | *Ventura County |

INTERIM



Company Operations Standard Gas Standard Gas Operations & System Integrity

Field Guidelines - Emergency Incident Distribution / Customer Service	SCG:	183.03
--	-------------	---------------

NOTE: Do not alter or add any content from this page down; the following content is automatically generated.

Brief: Policy was revised to added a verbiage to clarify Restoration of Gas Supply in Mains in section 4.6.4.1 through 4.6.4.3. These changes shall be reviewed by field employees as per section 2.3 of the policy. Updated Hyperlinks.

Document Profile Summary	
Responsible Person:	[REDACTED]
Published On:	02/09/2018
Last Full Review Completed On:	05/28/2015
Writer:	[REDACTED]
Document Status:	Active
Document Type:	GAS
Category (Prior FCD system only):	
If Merged, Merged To Document Number:	
Utility:	SoCalGas
Department:	Gas Operations & System Integrity
Number of Common Document (if applicable):	G8202
Contains OPQUAL Covered Task:	No
Part of SoCalGas O&M Plan:	Yes
Part of SDG&E O&M Plan:	No
Last O&M Review date:	2017-08-23
O&M 49 CFR Codes & Impacted Sections of Document:	192.615(a)(1): Entire Doc 192.615(a)(2): Entire Doc 192.615(a)(3): Entire Doc 192.615(a)(4): 4.2, 4.9 192.615(a)(5): 4.1, 4.2 192.615(a)(7): Entire Doc 192.615(a)(8): 1.2, 4.2.2, 4.2.9, 4.2.10, 4.6.1, 4.7.1 192.615(b)(2): 2.3, 2.4
Part of Non-O&M Parts 191-193 Plan	No
Non-O&M 49 CFR Codes & Impacted Sections of Document	
Part of Distribution IMP (DIMP)	Yes
Part of Transmission IMP (TIMP)	No
Part of Storage IMP (SIMP)	No
Impacts GO112F	Yes
GO112F Codes & Impacted Sections of Document	143.4: 2.4
Impacts GO58A	No
GO58A Codes & Impacted Sections of Document	
Impacts GO58B	No
GO58B Codes & Impacted Sections of Document	
Indices/Binders in Which Document is Filed:	MR, MS, LSDP, EP, EMGM, DISTM, DIMP2, CSF
NOP Learning Module (LM) Training Code:	NOP00280

Company Operations Standard Gas Standard Gas Operations

Planning Shutdowns for Transmission and Storage	SCG:	223.0145
--	-------------	-----------------

PURPOSE **The purpose of this Gas Standard is to describe the planning, coordination, and notifications necessary for planned and emergency shutdowns of Transmission and Storage Operations pipelines, compressor stations, and storage fields.**

1. **POLICY AND SCOPE**

1.1. Gas facility shutdowns which require a written shutdown plan:

- **Transmission Pipelines** — all work on transmission pipelines except work of very short duration (e.g., stroking valves as part of preventative maintenance inspection).
- **Compressor Stations** — all work that reduces the throughput capacity of station, except work on individual units which results in reduction of throughput for less than two hours
- **Underground Storage Fields** — all work affecting injection or withdrawal capability, except routine well testing (e.g. sand test, individual engine use for unloading wells).

NOTE: All Transmission and Storage shutdowns, even those not requiring written plan, must be coordinated through Gas Control and must receive Gas Control approval prior to commencement. (Certain emergency situations are excepted — see Section 4.4, below.)

2. **RESPONSIBILITIES & QUALIFICATIONS**

- 2.1. **Transmission and Storage Operations** develop written plans for coordination and execution of gas facility (pipeline, compressor station, storage field) shutdowns to ensure operational effectiveness, as well as public, employee, and facility safety.
- 2.2. **Transmission and Storage Operations** will coordinate all planned and probable shutdowns with **Gas Control** ahead of the proposed shutdown period.
- 2.3. **Project Managers, operating supervisors, and other Company personnel** responsible for projects that necessitate shutdowns shall notify **Energy Markets** and/or **Commercial/Industrial** when shutdowns affect the flow of gas to Utility Electrical Generation (UEG)/wholesale customers or that would affect producers.
- 2.4. **Gas Control** reviews forecasted shutdowns and related plans; coordinates changes in planning schedules; coordinates with suppliers, producers, and UEG/wholesale customers and advises **operating supervisors** regarding gas handling arrangements (valve operations, etc.).

Planning Shutdowns for Transmission and Storage	SCG:	223.0145
--	-------------	-----------------

3. DEFINITIONS

- 3.1. EOC – Emergency Operations Center for Company
- 3.2. GEC – Gas Emergency Center for Region
- 3.3. Isolated Section – any section of pipeline facility that is physically shutdown in an emergency or planned shutdown
- 3.4. Shutdown – Any work that restricts the use or availability of transmission pipelines, compressor stations, or storage fields, including instrumentation repair and calibration at affected facilities and pipelines

4. PROCEDURE

4.1. Planned Shutdown

- 4.1.1. **Transmission and Storage Operations** shall notify **Gas Control** of any possible timing flexibility to enhance coordination with other planned shutdowns.
- 4.1.2. Notify the following affected parties (if affected):
 - **Transmission Technical Services Manager**
 - **Storage Technical Services Manager** and affected **Storage Operations Manager**
 - The affected **Distribution Region Technical Services Manager**
- 4.1.3. Plan work so that the duration of the shutdown is held to a minimum.
- 4.1.4. Working with **Gas Control** and **Distribution Region Technical Services**, plan to minimize gas blown to atmosphere through the use of **Distribution** facilities to reduce gas pipeline inventory. **Any project that requires gas blown to atmosphere will build time into the project schedule to reduce methane consistent with safe operations and consider alternative potential sources of supply to reliably serve customers and maintain feasibility. Operating pressure should be reduced to the lowest operationally feasible level in order to minimize methane emissions before non-emergency venting of high-pressure distribution (above 60 psig), transmission and underground storage infrastructure consistent with safe operations. and whenever practicable, work should be bundled to prevent multiple venting of the same piping.**
- 4.1.5. Consult with **Gas Control** and **Distribution Region Technical Services** as necessary to plan and coordinate activities with other **Transmission and Storage Operations** organizations, affected **Distribution Regions**,



Company Operations Standard Gas Standard Gas Operations

suppliers, producers, and customers.

- 4.1.6. Plan and execute shutdowns to assure that pressures in adjoining sections of the pipeline will not drop below minimum operating requirements. As necessary during the planning and execution phases, consult with affected **Distribution Region Technical Services and Gas Control**.

**Company Operations Standard
Gas Standard
Gas Operations**

Planning Shutdowns for Transmission and Storage	SCG:	223.0145
--	-------------	-----------------

4.1.7. When tentative arrangements can be reasonably determined, contact:

- **Gas Control**
- The affected **Distribution Region Technical Services** to plan remedial action on the distribution system and for notifications, such as transportation customers, etc.
- Producers, where affected.

4.1.8. The following notifications will be made in advance of scheduled shutdowns:

- **Gas Control**; prior to the shutdown gas control shall be notified in advance of the shutdown schedule.
- The affected **Distribution Regions Technical Services** to schedule remedial action on the distribution system and for notification of customers, such as transportation customers, etc.
- UEG/wholesale customers and producers, when affected

4.1.9. To confirm arrangements and schedule of all shutdowns, prepare and distribute [Form 3506](#), *Notice of Shutdown / Operational Deviation* prior to the date of shutdown. If the date of the shutdown is likely to change, make a note to that effect on [Form 3506](#). Reach an agreement between the **Transmission and Storage Operations** organization, **Distribution Regions**, other affected parties, and **Gas Control** as to the minimum amount of time prior to the shutdown that a firm date must be set.

4.1.10. Each written plan (see Section 4.2) is reviewed by the appropriate responsible **Transmission or Storage Operations management personnel**.

4.1.11. Prior to the shutdown, give a copy of the written plan to and review with each person assigned to work on the project. When a contractor is providing work forces for a tie-in, give a copy of the plan to the **contractor's supervisors**. A pre-shutdown briefing is conducted by the **Transmission or Storage Operations management person** responsible for directing the operation.

4.1.12. Confirm shutdown arrangements by calling **Gas Control** and the affected **Distribution Region Technical Services** prior to the beginning of the shutdown.

NOTE: Gas Control has the authority to approve and to disapprove shutdowns if conditions warrant.

Planning Shutdowns for Transmission and Storage	SCG:	223.0145
--	-------------	-----------------

4.1.13. If gas is to be blown to atmosphere, notify public authorities (police, fire, Civil Aeronautics Administration [CAA] when appropriate, Air Quality Management District [AQMD], airport authorities, highway or street departments, etc.), and nearby businesses and residents, including local home-owner groups and associations. Also, notify interested Company departments.

4.1.14. Make regular phone or radio reports to the **Gas Control Supervisor** and affected **Distribution Regions** concerning job progress, such as status, estimated time of completion, valve operations, when delayed, when completed, etc.

4.1.15. Return the facility to normal service and coordinate with **Gas Control** to insure proper line pack and gas routing.

4.1.16. Document pressure prior to blowdown and complete [Form 3466, Reporting of Gas Blown to Atmosphere](#).

4.2. Written Plans

4.2.1. **Transmission and Storage Operations** develop written plans for handling planned shutdowns. Plans are specific and definitive in order to maintain well established operations.

4.2.2. The written plan for handling shutdowns under emergency conditions is of necessity general in nature because operations and conditions vary from one shutdown to another.

Written Plans — Field Operations

4.2.3. **Transmission and Storage Operations** provide their field operations personnel with a written plan for gas facility shutdowns delineating all critical activities associated with the shutdown.

4.2.4. The plan and subsequent job discussion includes, but is not limited to, the following information. The level of detail should be appropriate to the safe and efficient completion of the project:

- List of work to be accomplished prior to the shutdown.
- List of crucial equipment needed at the job site including hazardous materials cleanup equipment.

Company Operations Standard Gas Standard Gas Operations

Planning Shutdowns for Transmission and Storage	SCG:	223.0145
--	-------------	-----------------

- List of all concerned governmental agencies, affected **Distribution personnel**, other Company personnel, local businesses, and residents to be notified.
- Sequence of operations, including numbers and locations of valves to be operated and the estimated time when these operations will occur.
- Schematic of the section to be shut down with all pertinent valves and valve positions clearly labeled.
- List of all active customer and **Distribution** taps.

NOTE: All taps feeding a customer(s) or **Distribution Operations** systems must have a plan for an alternate feed that identifies who is responsible for the alternate feed.

- Schematics of the installation and removal sections.
- Detailed step-by-step procedure for all fire-control activities. See Gas [Standard 223.0165](#), *Controlled Fire Operations*.
- Detailed, step-by-step procedure for any purge performed. See Gas [Standard 182.0160](#), *Purging Pipelines and Components*.
- Plan for personnel protection using Lockout/Tag-out when required.
- Indicate any changes to telemetry (i.e., if data signals will be out of service or unavailable).

Written Plans — Gas Control

4.2.5. **Transmission and Storage Operations** provide **Gas Control** with a written plan for gas facility shutdowns which includes, but is not limited to, the following information:

- Sequence of operations, including numbers and locations of valves to be operated and the estimated time when these operations will occur
- Schematic drawing of the section to be shut down with all pertinent valves and valve positions clearly labeled.
- List of all active customer and **Distribution** taps.
- Schematic drawings of the installation and removal sections.

Planning Shutdowns for Transmission and Storage	SCG:	223.0145
--	-------------	-----------------

4.3. **Gas Control** Shutdown Activities

- 4.3.1. Review list of forecasted shutdowns.
- 4.3.2. Identify schedule conflicts.
- 4.3.3. Coordinate changes in planning schedules.
- 4.3.4. Advise **operating management** regarding gas handling arrangements.
- 4.3.5. Notify **Distribution Region Technical Services** as to whether their planned operations are deemed significant or not.
- 4.3.6. When a shutdown impacts the systems capability to accept full out-of-state supplies, a System Status Information report with shutdown details will be posted on the Company's on-line electronic communications system (**EEB**) as soon as the information is known as required by Remedial Measure 23.
- 4.3.7. As soon as it becomes evident that deliveries to a UEG customer are (or may be) affected, notify the appropriate **Energy Markets personnel**. Confirm shutdown prior to onset of actual work. For other major customers, notify **Commercial/Industrial**.
- 4.3.8. Before the shutdown, the **Gas Control Supervisor** works with **Transmission** to plan for alternate operations while arranging the transition to normal gas operations at the completion of a shutdown. During the shutdown, **Gas Control** operates the system.

NOTE: The **Gas Control Supervisor** has the authority to stop or change a shutdown during its progress.

4.4. Emergency Shutdown Plans

4.4.1. **Transmission and Storage Operations** Responsibilities

- 4.4.1.1. Each **Transmission and Storage Operations** organization's emergency shutdown plan is modified to meet the needs of each situation and to assure the facility is back in service as soon as possible.

Attachment J
Company Operations Standard
Gas Standard
Gas Operations

Planning Shutdowns for Transmission and Storage	SCG:	223.0145
--	-------------	-----------------

4.4.1.2. In the event of a major, wide-spread emergency (i.e. earthquake, terrorist attack, flooding, firestorm, etc.) and a **GEC** and the **EOC** are both open and operational to respond to the event, the **GEC** should consider the following three (3) factors for alerting and involving the **Executive-in-Charge** at the **EOC** and **Gas Control** before implementing a large isolated section in the gas system unless Section 4.4.1.4 applies:

[Redacted]

- [Redacted]

- [Redacted]

[Redacted]

- [Redacted]

 - [Redacted]

 - [Redacted]

- [Redacted]

- [Redacted]

- [Redacted]

- [Redacted]

 - [Redacted]

 - [Redacted]

 - [Redacted]

- [Redacted]

Planning Shutdowns for Transmission and Storage	SCG:	223.0145
--	-------------	-----------------

3. Requiring Inter-Region Coordination or Mutual Assistance

- Response across multiple operating organizations or with assistance from outside the Company required to implement the isolated section

4.4.1.3. The responsible **Transmission** or **Storage Operations management person** shall:

- Initiate a Message Center Report. See **183.0110**, *Field Procedure – Emergency Incidents – Transmission*.
- Consults with the **Gas Control Supervisor** to arrange the re-routing of gas flow and/or obtain permission to close off connections prior to shutting down.

4.4.1.4. **Transmission** or **Storage Operations** personnel may operate valves that affect gas flow without first clearing with the **Gas Control Supervisor** only when the responsible **Transmission** or **Storage Operations** management person at the site determines either of the following:

- Injury or death have occurred or is imminent
- Communications are not possible from the site and leaving the site would risk additional damage or injury. In such the **Gas Control Supervisor** is notified at the first opportunity directly or by **GEC** (if operational).

4.4.2. **Gas Control** Responsibilities

4.4.2.1. Re-routes supplies, as required.

4.4.2.2. Post outages impacting capacity in Envoy.

4.4.2.3. Notifies **Energy Markets**, when UEG and/or wholesale customers are affected.

5. OPERATOR QUALIFICATION COVERED TASKS

(See [GS 167.0100](#), *Operator Qualification Program, Appendix A, Covered Task List*)

- **Task 16.2** - 49 CFR 192.745 – Inspecting, operating, and maintaining transmission pipeline valves



Attachment J
**Company Operations Standard
Gas Standard
Gas Operations**

Planning Shutdowns for Transmission and Storage	SCG:	223.0145
--	-------------	-----------------

6. RECORDS

- 6.1. Completed [Form 3506](#) and the completed procedure or work instructions package for the project that necessitated the shutdown must be retained for life of the pipeline asset.

INTEGRITY



Company Operations Standard Gas Standard Gas Operations

Planning Shutdowns for Transmission and Storage	SCG:	223.0145
--	-------------	-----------------

NOTE: Do not alter or add any content from this page down; the following content is automatically generated.

Brief: The revisions were made to sections 4.1.8, 4.1.9, 4.1.12, 4.3.6, and 4.3.7. Revisions will allow some flexibility when working with gas control and planning shutdowns for new construction, storage system maintenance or transmission line repair

Document Profile Summary	
Responsible Person:	
Published On:	07/24/2014
Last Full Review Completed On:	07/24/2014
Writer:	
Document Status:	Active
Document Type:	GAS
Category (Prior FCD system only):	
If Merged, Merged To Document Number:	
Utility:	SoCalGas
Department:	Gas Transmission Planning
Number of Common Document (if applicable):	G8147
Contains OPQUAL Covered Task:	Yes
Part of SoCalGas O&M Plan:	Yes
Part of SDG&E O&M Plan:	No
Last O&M Review date:	2017-08-18
O&M 49 CFR Codes & Impacted Sections of Document:	192.615(a)(6): 4.4 192.605(b)(5): 4
Part of Non-O&M Parts 191-193 Plan	No
Non-O&M 49 CFR Codes & Impacted Sections of Document	
Part of Distribution IMP (DIMP)	No
Part of Transmission IMP (TIMP)	Yes
Part of Storage IMP (SIMP)	No
Impacts GO112F	No
GO112F Codes & Impacted Sections of Document	
Impacts GO58A	No
GO58A Codes & Impacted Sections of Document	
Impacts GO58B	No
GO58B Codes & Impacted Sections of Document	
Indices/Binders in Which Document is Filed:	TRAN, TIMP2, STOR, DISTM
NOP Learning Module (LM) Training Code:	NOP00610

**Company Operations Standard
Gas Standard
Gas Operations & System Integrity**

Leakage Surveys	SCG:	223.0100
------------------------	-------------	-----------------

PURPOSE To describe the methods, required intervals, and record keeping requirements for leakage survey on Company’s facilities. The objective of a leakage survey is to conduct a thorough search for gas leak indications in an assigned area and report all detectable leaks using an approved survey method.

1. POLICY AND SCOPE

1.1. Leakage surveys are performed by Transmission, Distribution and Storage of gas facilities at specified intervals by using the methods specified in this Gas Standard. This document establishes the frequency of leak surveys and specifies record keeping procedures to comply with Company and regulatory requirements.

2. RESPONSIBILITIES AND QUALIFICATIONS

2.1. **Field Organizations (Gas Transmission Districts, Distribution Regions, and Storage Operations)** are responsible for performing leak surveys per this procedure at the minimum intervals identified in **Section 4**. Surveys may be performed at more frequent intervals.

2.2. **Field Organizations (Gas Transmission Districts, Distribution Regions, and Storage Operations)** are responsible for selecting the appropriate leak survey method for each portion of their facilities per **Table 3** of this procedure.

2.3. **Field Organizations (Gas Transmission Districts, Distribution Regions, and Storage Operations)** are responsible for notifying the appropriate scheduler of maintenance inspections of any field conditions which may warrant a change in the leak survey schedule.

2.4. The employee performing the leakage survey must be qualified per **GAS STANDARD 167.0100**, “*Operator Qualification Program*.”

2.5. If a boat is required for performing a leakage survey, the watercraft used must comply with the governmental regulations and licensing requirements for its type.

2.5.1. The operator of any rented or owned Company boat must first complete and successfully pass a Boating Safety Course approved by the California Department of Boating and Waterways (CDBW).

2.5.2. The CDBW offers a boating course at no charge. See the website at <http://www.dbw.ca.gov/BoaterInfo/BSCourses.aspx> .

Leakage Surveys	SCG:	223.0100
------------------------	-------------	-----------------

2.5.2.1. Personnel working in watercraft MUST wear a Coast Guard-approved life vest.

Other recommended PPE:

- Mosquito repellent.
- Sunscreen.

3. DEFINITIONS

- 3.1. **HCA** – High Consequence Area. Refer to **GAS STANDARD 192.02**, *Procedure for HCA Segment Identification*.
- 3.2. **Location Class** – See **GAS STANDARD 182.0190**, *Location Class – Determination and Changes*
- 3.3. **Department of Transportation Defined Transmission Line (DOT-T)** – See **GAS STANDARD 223.0415**, *Pipeline and Related Definitions*.
- 3.4. **Business District** – Is an area identified on a leak survey map that depicts where distribution facilities are located within 100 feet of the property line of a land parcel that has been identified as being a potential commercial gathering place, a church, a school, a hospital or is location where people have limited mobility. The extent of the business district boundaries have been determined per the procedure outlined in **GAS STANDARD 223.0102**, *Updating of Leak Survey Maps*.
- 3.5. **Maximum Allowable Operating Pressure (MAOP)** See **GAS STANDARD 223.0415**, *Pipeline and Related Definitions*.
- 3.6. **Non-State-of-the-Art Pipe (NSOTA)** – Steel pipe, bare or coated, without cathodic protection (CP), and all DuPont Aldyl-A (PE) pipe installed before 1986. See **GAS STANDARD 184.03**, *Replacement Criteria for Distribution Mains and Services*.
- 3.7. **State-of-the-Art Plastic Pipe (SOTA)** – Yellow or Orange TR418 resin, and 1986 and later Aldyl-A pipe. See **GAS STANDARD 184.03**, *Replacement Criteria for Distribution Mains and Service*.
- 3.8. **Barhole:** Probing or drilling holes in the surface (approximately 18 inches deep) to identify leakage using an approved leak detection instrument.
- 3.9. **DP-IR: The Detecto Pak-Infrared®** is a portable optical-based methane gas detector to sample the atmosphere for gas near the ground surface using Infrared Controlled Interference Polarization Spectrometry. For additional instrumentation specifications, see **GAS STANDARD 107.0294**, *DP-IR Heath Detecto Pak-Infrared*.
- 3.10. **RMLD: The Remote Methane Leak Detector** – used as a portable “line of sight” laser based methane gas detector to detect gas leaks from a remote distance (up to



Company Operations Standard Gas Standard Gas Operations & System Integrity

Leakage Surveys	SCG:	223.0100
-----------------	------	----------

100') by passing a laser through a gas plume. See [GAS STANDARD 107.0293](#), *RMLD-Remote Methane Leak Detector*.

- 3.11. **OMD: The Optical Methane Detector** method uses an optical-based methane detector mount in front of a vehicle to detect gas that passes between the light transmitter and receiver. The presence of methane is displayed in analog and digital form inside the vehicle. See [GAS STANDARD 223.0104](#), *Optical Methane Detector Operation and Maintenance*.

4. PROCEDURE

- 4.1. Table 1 is a summary of the minimum leak survey frequencies for pipe based upon location and operating status. See the referenced section of this procedure listed in Table 1 under 'Additional Requirements for detailed requirements.

INTERNA

Attachment K
**Company Operations Standard
Gas Standard
Gas Operations & System Integrity**

Leakage Surveys	SCG:	223.0100
------------------------	-------------	-----------------

Table 1: Leak Survey Frequencies

Pressure	Operating Location or Operating Status	Frequency	Additional Requirements
Medium Pressure	Main Located Within a Business District	At least once each calendar year	see Sect. 4.3.1
	Main Located Outside of a Business Districts and cathodically unprotected.	At least once every 3 each calendar years	see Sect. 4.3.2
	All Non-State-of-the-Art PE main located outside a Business District and associated services	At least once each calendar year	see Sect. 4.3.3
	All other medium pressure main located outside a Business District and associated services	At least once every 5 calendar years	see Sect. 4.3. 3 4
High Pressure (over 60 psig)	All high pressure pipe not including DOT-T Pipe	At least once each calendar year	see Sect. 4.4
DOT Defined Transmission Pipe (DOT-T)	Located in Non-HCA, Class 3	At least twice each calendar year	see Sect. 4.5.1
	Located in Non-HCA, Class 4	At least 4 times each calendar year	see Sect. 4.5.2.1
	Cathodically Unprotected Pipe, located in All Classes	At least 4 times each calendar year	see Sect. 4.5.2.2
	All other DOT-T Pipe	At least twice each calendar year	see Sect. 4.5.1

4.2. See **GAS STANDARD 184.0005**, *Scheduling Distribution Tests and Inspections*, for requirements of establishing anniversary months.

4.3. **Medium Pressure Pipelines (Operating at 60 psig or Less)**

4.3.1. Survey all pipe (including services) in business districts at an intervals not exceeding 15 months, but at least once each calendar year.

4.3.2. Survey cathodically unprotected main pipe and connected services where the main is not located in a business district at **an intervals not exceeding 15 months, but at least once each calendar year. ~~least once every 3 calendar years at intervals not exceeding 39 months.~~**

Leakage Surveys	SCG:	223.0100
------------------------	-------------	-----------------

4.3.3. Survey **Non-State-of-the-Art PE main where the main is not located in a business district once every calendar year at intervals not exceeding 15 months.**

4.3.4. Survey **all State-of-the-Art PE and cathodically protected main where the main is not located in a business district once every 5 calendar years at intervals not exceeding 63 months.**

4.4. **High Pressure Pipelines (Operating over 60 Psig) not including DOT-Transmission Pipelines**

4.4.1. Survey all pipelines and associated taps, cross-over piping, services and other piping every 15 months; but at least once every calendar year annually for all location classes.

4.5. **DOT-Transmission Pipelines**

4.5.1. **Non-HCA Transmission Pipeline Segments in Location Class 3* and all DOT-T pipe not covered in Section 4.5.2.1 and 4.5.2.2.**

4.5.1.1. Survey every 7½ months; but at least twice each calendar year

4.5.2. **Non-HCA Transmission Pipeline Segments in Location Class 4 and Transmission Pipelines in all Location Class without CP**

4.5.2.1. Survey Non-HCA Transmission Pipeline in Location Class 4 every 4½ months; but at least 4 times each calendar year.

4.5.2.2. If no CP is on a transmission pipeline (in any Location Class) or if electrical surveys are impractical, then survey every 4½ months; but at least 4 times each calendar year.*

***Note:** The implementation deadline to schedule future surveys for all non-HCA transmission pipelines according to the requirements in 49 CFR 192.935 was December 17, 2007. From this date forward surveys shall be performed in accordance with this survey-interval requirement.

4.6. **Special Survey**

4.6.1. Special leak surveys are one time, additional survey to the routine scheduled survey that is driven by a specific circumstance. Perform special leak survey when:

4.6.1.1. Upon discovery that the MAOP of a pipeline is exceeded by 10% or more at any time during the life of the pipeline.

Note: When the MAOP of a pipeline is exceeded by 10% or more, contact Pipeline Integrity for guidance concerning any additional actions to be taken that could facilitate further analysis of the longer term impact on the integrity of the pipe.

- 4.6.1.2. After the occurrence of any significant incident (e.g., train derailment, explosion, earthquake, flooding, landslides, etc.) over or adjacent to high pressure pipelines or related facilities. See **GAS STANDARD 183.03**, *Field Guidelines – Emergency Incident Distribution / Customer Service* or **GAS STANDARD 183.0110**, *Field Procedures- Emergency Incidents-Transmission* for confirming survey requirements.
- 4.6.1.3. There is the danger of public exposure to leaking gas; the special survey is performed using the appropriate leak detection method shown in Table 3. Document the reason, location, limits, and results of all special leak surveys on the appropriate Company inspection record.
- 4.6.1.4. When increasing the MAOP of a pipeline, per **GAS STANDARD 182.0040**, *Changing Maximum Allowable Operating Pressure and Maximum Operating Pressure*.
- 4.6.1.5. When the routine scheduled survey frequency are not considered adequate because of pipe condition, limited opportunity for gas to vent safely, or other reasons. When the special surveys will be on-going and scheduled, efforts shall be made to identify the segment of pipe to be at the greater frequency in SAP and EGIS, and be scheduled as routine.
- 4.6.1.6. There is a need to monitor pipe condition for special situations, such as:
- 4.6.1.6.1. Material evaluations.
 - 4.6.1.6.2. Proposed street improvement projects.
 - 4.6.1.6.3. As a mitigated measure for the Integrity Management Program.
- 4.6.1.7. Survey at the frequency listed in Table 2 based upon the location of the known shorted casing, confirmed to be shorted through inspection and testing and have not been repaired/cleared according to **GAS STANDARD 186.06**, *Cathodic Protection – Electrical Isolation*

Attachment K
**Company Operations Standard
 Gas Standard
 Gas Operations & System Integrity**

Leakage Surveys	SCG:	223.0100
------------------------	-------------	-----------------

Table 2: Known Shorted Crossing Survey Frequency

Location Class	Frequency
Highway and Railroad Crossings	7½ months; but at least twice each calendar year
All Other Locations	15 months; but at least once every calendar year

4.6.2. A *special leak survey* may require special accounting; contact Field Operations Supervisor for proper account numbers.

4.6.3. Special leak survey may also be considered in conjunction with major underground construction projects, see [GAS STANDARD 184.09](#), *Prevention of Damage to Company Facilities*.

5. APPLICATION OF LEAK SURVEY METHODS

5.1. Field Operations must follow Table 3 when selecting an approved method for performing leakage surveys of Transmission and Distribution Facilities.

Table 3: Approved Leak Survey Method by Facility

Facility	DP-IR	OMD Mobile	RMLD	Barhole
Med Press. Pipe (Annual; and 3yr, 5yr)	X	*X	*X	X
High Press. Pipe Over 60 psig (Annual)	X	*X	*X	X
DOT-T Transmission (Class 1,2)	X	*X	X	X
DOT-T Transmission (Class 3, 4)	X	*X	X	X
Shorted Casing	X		X	X
Pipe over Waterways	X		X	

*see sub-section for limitations

Leakage Surveys	SCG:	223.0100
------------------------	-------------	-----------------

5.2. INSTRUMENTED SURVEY METHOD

- 5.2.1. The method consists of using an approved leak survey instrument listed in Table 3 to sample the atmosphere near the surface of the ground in the vicinity of buried company facilities, and in street openings and other accessible crevices and locations where gas is likely to vent.
- 5.2.2. Survey shall include visual examinations of all Company above ground facilities (See [STANDARD 167.0100](#), “Operator Qualification Program”, Appendix B, *ABNORMAL OPERATING CONDITIONS*). Search along the route of the pipe at all locations where gas is most likely to vent. Determine pipe location as accurately as possible using map, existing paint marks, old patches, line markers, etc.
- 5.2.3. For non-mobile survey methods, choose locations such as loose earth, paving cracks, old bar holes, repair patches and around the base of poles, trees, fence posts, etc., if they are near the pipe.
- 5.2.4. Watch for, and check areas where vegetation appears to be affected by gas leakage.

Note: Grass and vegetation areas can be affected in several ways: There may be patches of brown, dry, even dead grass. In some instances, affected vegetation and grass may appear very green compared to surrounding areas.

- 5.2.5. Search along the route of all services at locations where gas is most likely to vent using appropriate instrumentation.
 - 5.2.5.1. Determine the service location as accurately as possible using the map, curb markings, meter location, etc. If any doubt exists as to route of the service such as at corner lots, check both possible routes.
 - 5.2.5.2. Search as close to the service location as practical, over earth, at building foundations or at cracks and/or paving edge if service is under paving.
 - 5.2.5.3. Search along all services from the curb or pavement edge to the riser. Check at service-to-main connections if traffic permits.
 - 5.2.5.4. Check all manholes and other street openings such as valve casings, curb meter vaults, drains, water valves, meter boxes, street lighting, power, telephone, etc.

**Company Operations Standard
Gas Standard
Gas Operations & System Integrity**

Leakage Surveys	SCG:	223.0100
------------------------	-------------	-----------------

5.2.5.5. For long-side services it is necessary to visibly look for indications of possible leakage under the street such as: evidence of recent construction, foreign trench marks, pavement cuts, bar holes, etc. along the service route. Where visible indications are present, use approved ground leak detection equipment such as DP-IR or RMLD.

Note: When casing vents are presents they must be inspected to ensure they are in satisfactory condition and designed to prevent entry of water, insects, and other foreign matter. Vents should extend at least four feet above finished grade and at least four feet below overhead electric wires. Vents shall be located in an area away from traffic and other hazardous locations.

5.2.5.6. Survey all risers and other above ground Company Infrastructure including meters set assemblies. If a riser and connected facility is not readily accessible by customer contact or other means during the regular survey, and the survey cannot be completed using the RMLD (see 5.2.5.7 below), the “cannot get in” (CGI) must be documented for a follow-up to complete the survey. Check the riser and any portion of the service that was not surveyed. The follow-up shall be completed within the established compliance window for the inspection.

5.2.5.7. Districts have the option of utilizing a Remote Methane Leak Detector (RMLD) to check services up to the riser when access is restricted. See [GAS STANDARD 107.0293](#), *RMLD – Remote Methane Leak Detector*. Only qualified employees who are properly trained may use the RMLD for gas leak detection.

Note: Districts are responsible for tracking and completing services that are not accessible at the time of survey (commonly referred to as “Can’t Get Ins” (CGIs). Records should be kept per the retention scheduled identified Section 11.

5.2.5.8. Check the casing end inside the building when a service enters a building. Reseal the casing end.

5.3. OMD MOBILE SURVEY METHOD

**Company Operations Standard
Gas Standard
Gas Operations & System Integrity**

Leakage Surveys	SCG:	223.0100
------------------------	-------------	-----------------

5.3.1. This method consists of driving a vehicle along the route of the underground gas piping and sampling the atmosphere near the earth or paving over the pipe or paving edge with sensitive continuous sampling leak detection equipment especially designed and engineered for mounting on a vehicle. See GAS [STANDARD 223.0104](#), *Optical Methane Detector Operation and Maintenance*.

5.3.2. The OMD is to be used to perform leakage survey on buried piping that can be directly driven over with a vehicle equipped with an OMD. Associated services, crossovers and other buried infrastructure that cannot be driven over shall be surveyed using appropriate instrumentation (See section 5.2). OMD mobile leak survey is typically used on high pressure and medium pressure pipelines that have few and/or infrequent taps/services. Any services, taps, or other pressure carrying facilities that are part of the survey work order and are not suitable for survey by OMD must be surveyed with an appropriate device (see Section 5.2).

5.4. **BARHOLE**

5.4.1. Prior to drilling bar holes, notify Underground Service Alert (USA). Refer to GAS [STANDARD 184.0200](#), *Underground Service Alert and Temporary Marking*.

5.4.2. Drill a hole over the suspected leak area and surrounding facilities for the specific purpose of testing for subsurface gas indications per GAS [STANDARD 107.0287](#), *GMI Gasurveyor – Combustible Gas Indicator (CGI)*.

5.4.3. Use an instrument probe, such as the combustible gas indicator, e. g., GMI Gasurveyor – Combustible Gas Indicator (CGI). Read, interpret and code gas indications per GAS [STANDARD 223.0125](#), *Leakage Classification and Mitigation Schedules*.

5.4.4. The DP-IR can also be used for barhole survey by using the probe assembly. See Gas [Standard 107.0294](#), *DP-IR Heath Detecto Pak-Infrared*.

5.5. **WATER CROSSING**

5.5.1. **SAFETY**

5.5.1.1. Serious bodily injury could occur when entering waterways without proper training and personal protective equipment (PPE). See sections 2.5 for required and recommended PPE.

5.5.1.2. The following are examples of hazards impacting this work:

- 5.5.1.2.1. Weather and waterway conditions
- 5.5.1.2.2. Fast currents
- 5.5.1.2.3. Tripping and slipping hazards.
- 5.5.1.2.4. Sunburn from water reflection.
- 5.5.1.2.5. Drowning
- 5.5.1.2.6. Hypothermia.
- 5.5.1.2.7. Other watercraft.
- 5.5.1.2.8. Wildlife
- 5.5.1.2.9. Environmental surroundings.

5.5.2. SPECIAL REQUIREMENTS

5.5.2.1. Use only approved leak survey instruments listed in Table 3.

5.5.2.2. Minimum 2-foot by 4-foot background target to reflect an RMLD laser. The following may be used as a background target:

- 5.5.2.2.1. A second watercraft.
- 5.5.2.2.2. The shoreline.
- 5.5.2.2.3. Plywood or its equivalent.

5.5.2.3. When working in or along a waterway, arrange encroachment permission for access through entities having jurisdiction, which may include: Port Authority, Fish and Game, Port Police, Homeland Security, Coast Guard, and Harbor Patrol.

5.5.2.4. Flood control channels may need special notification and permission.

5.5.2.5. While operating a motorized watercraft, ensure that no trash or debris are discharged in to the water.

5.5.2.6. If there is an accidental fuel or oil discharge from the boat, notify Environmental Services immediately.

Attachment K
Company Operations Standard
Gas Standard
Gas Operations & System Integrity

Leakage Surveys	SCG:	223.0100
------------------------	-------------	-----------------

5.5.2.7. Consider the options or combination of options listed in Table 4 to select an appropriate survey technique for a waterway according to its characteristics. See Table 4.

Table 4: Waterway Access Options

Width of Waterway	Depth	Watercraft	Instrument	Technique Options
Less than 100ft	All	None	RMLD	Shore-to-Shore
				Shore-to-Target
Greater than 100ft	Less than 30"	Waders or flat-bottom push boat	RMLD	Waders or watercraft-to-target
				Waders or watercraft-to-shore
	Greater than 30" with limited launch ramp access	Non-Motorized watercraft (canoe, kayak, etc.)	RMLD	Watercraft to target
				Watercraft to shore
				Watercraft to watercraft
	Greater than 30" with launch ramp access	Motorized Boat	RMLD	Watercraft to target
Watercraft to shore				
Watercraft to watercraft				

5.5.2.8. The following conditions must be met to perform a waterway leak survey:

5.5.2.8.1. Wind speed must be 15 miles per hour (mph) or less.

5.5.2.8.2. Watercraft speed must be 3.9 knots (4.5 mph) or less.

5.5.2.8.3. Water must be still or in slack tide (consult local tide and current tables)

5.5.2.8.4. If the pipeline is in a location where the water is in constant flow and does not have times when it is still or in slack tide, then perform the following tasks when performing the survey:

Leakage Surveys	SCG:	223.0100
------------------------	-------------	-----------------

5.5.2.8.5. Give consideration to the current direction and speed.

5.5.2.8.6. Perform multiple survey passes from the pipeline crossing to downstream of the pipeline for the distance gas is anticipated to drift during a rise in the water.

5.5.2.9. Conform to the following constraints when performing all leak surveys:

5.5.2.9.1. Maintain the height of an RMLD to the waterline at 6 ft. or less. See Figure 1.

5.5.2.9.2. Maintain the height of a laser on a background target to the waterline at a minimum of 12 inches. But not more than 24 inches. See Figure 1.

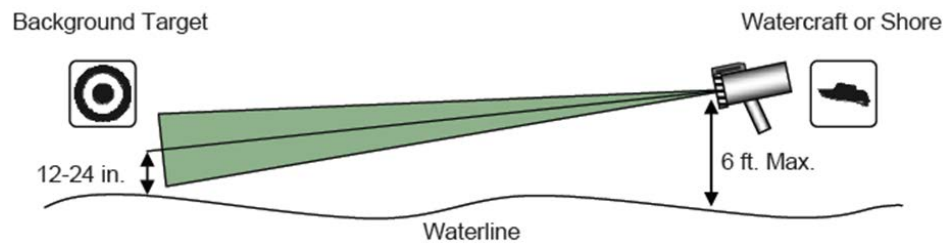

FIGURE 1

5.5.2.9.3. Proceed to the section identified below that is appropriate for the width of the waterway

5.5.3. Leak Surveying Waterways Less Than 100 Feet Wide

5.5.3.1. Perform the leak survey using an RMLD from shore to shore OR shore to a background target. See Figure 2.

Leakage Surveys	SCG:	223.0100
------------------------	-------------	-----------------

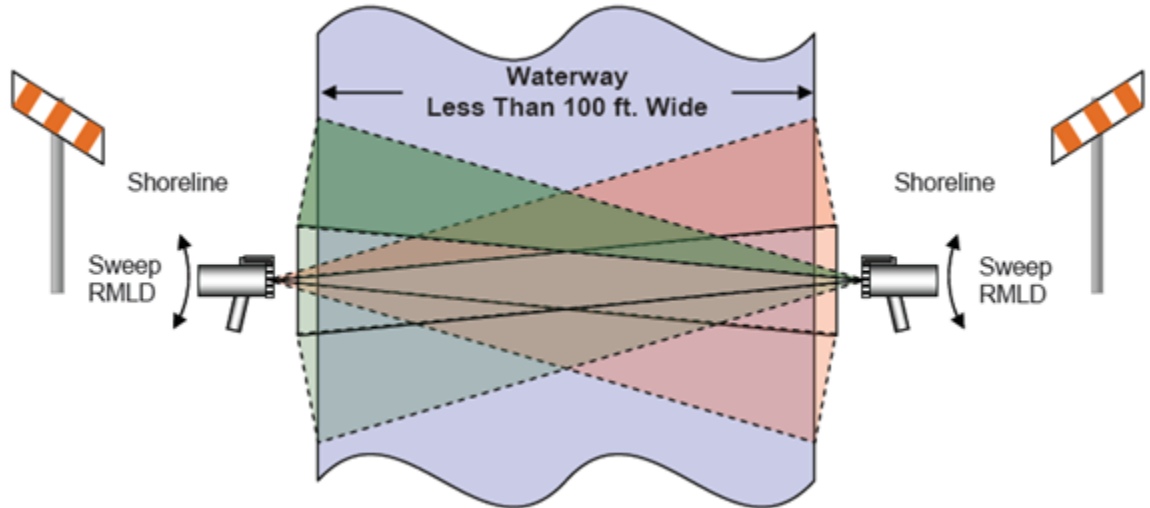

FIGURE 2

NOTE: As illustrated in FIGURE 2, if the shoreline is flat and the background reflection is not possible, a second person must hold a background target, as described in section 5.5.2.2.

5.5.4. Leak Surveying Waterways 100 to 120 Feet wide.

5.5.4.1. Perform leak survey using an RMLD from a watercraft in the waterway to the shoreline OR from a watercraft in the waterway to a background target 80 ft. away from the watercraft. See Figure 3.

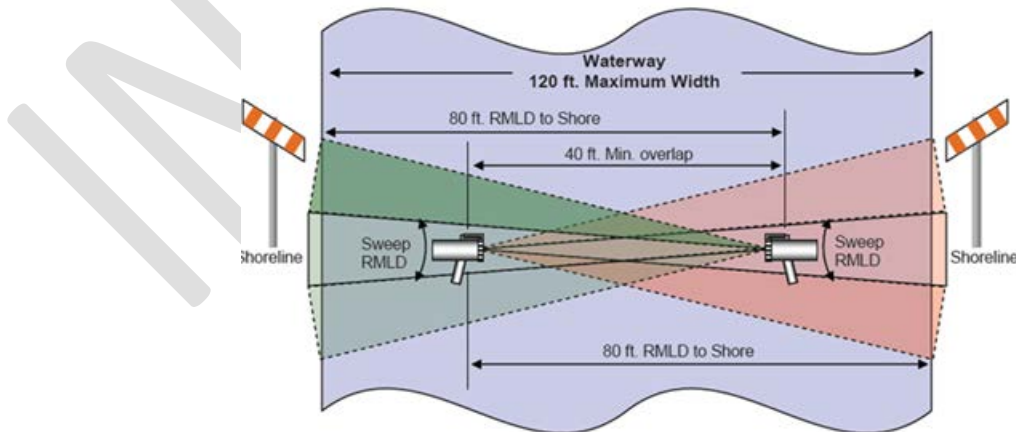

FIGURE 3

Leakage Surveys	SCG:	223.0100
------------------------	-------------	-----------------

5.5.5. Leak Surveying Waterways Greater Than 120 Feet Wide

NOTE: It may be efficient to have two surveyors survey simultaneously from watercraft to watercraft.

5.5.6. Leak Surveying Waterways Greater Than 120 Feet Wide

NOTE: It may be efficient to have two surveyors survey simultaneously from watercraft to watercraft.

- 5.5.6.1. Perform a leak survey using an RMLD from watercraft to watercraft or watercraft to a background target parallel to the pipeline (with the RMLD laser beams perpendicular to the pipeline being surveyed), adhering to the following criteria:
- 5.5.6.2. Maintain a minimum of 40 ft. AND a maximum of 80 ft. between the two watercraft or the watercraft and the background target.
- 5.5.6.3. Overlap survey laser beams by a minimum of 40 ft. See Figure 4
- 5.5.6.4. IF only one RMLD is used, THEN perform two survey passes, one in each direction, overlapping the areas covered by the laser beams by a minimum of 40 ft. See Figure 4.

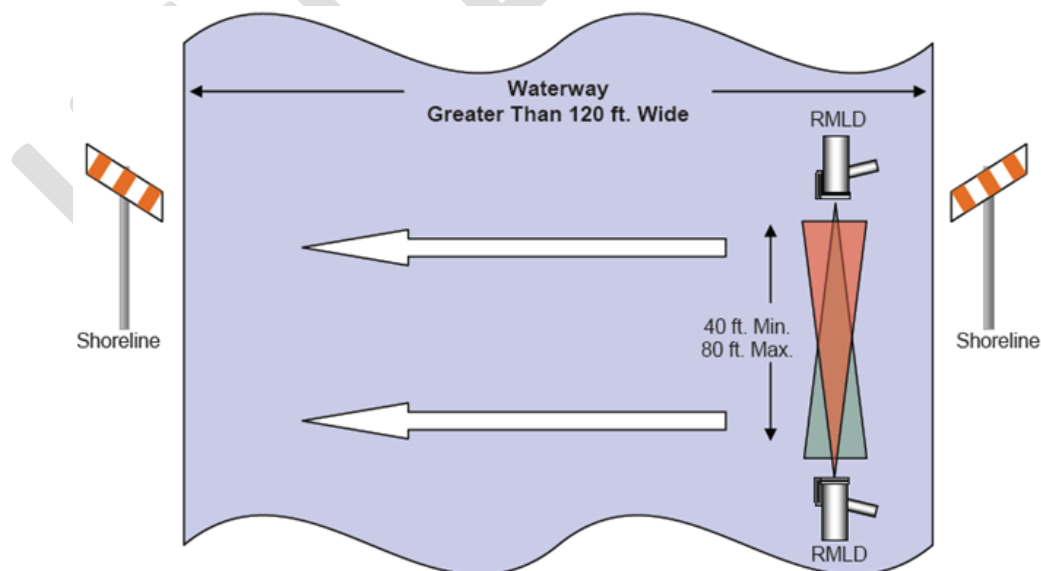

Leakage Surveys	SCG:	223.0100
------------------------	-------------	-----------------

FIGURE 4

5.5.6.5. Complete the survey to the shoreline using an RMLD from watercraft 80 ft. or closer to the shoreline or a background target. See Figure 5.

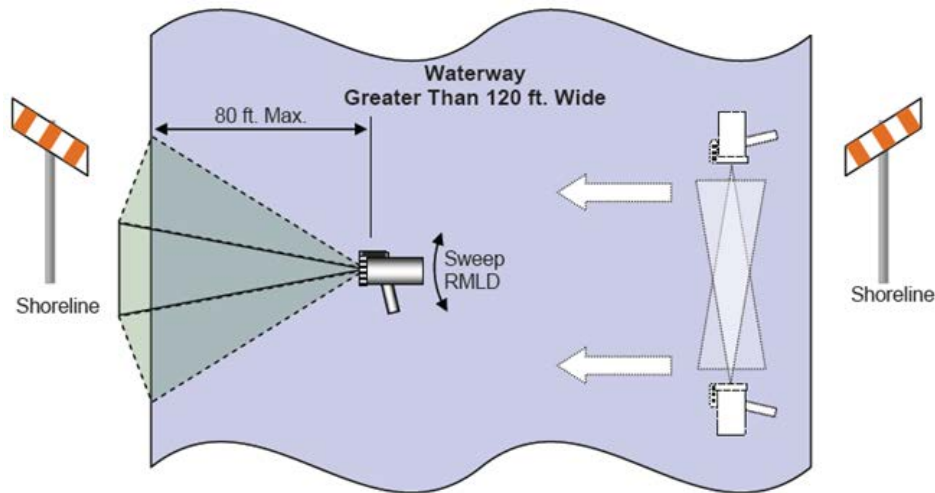

FIGURE 5

6. BUSINESS DISTRICTS

- 6.1. A business districts is an area that extends 100 feet from the property line of a parcel of property that has been identified as a significant commercial gathering point, a school, a hospital, a church or is a place where inhabitants have limited mobility.
- 6.2. Leak survey any distribution mains and associated services that have been identified as being within a business districts at the frequency established per Table 1.
- 6.3. The procedure for determining the business district is detailed in **GAS STANDARD 223.0102**, *Updating of Leak Survey Maps*.
- 6.4. If during the survey, the leak surveyor identifies land uses that could potentially trigger a business district determination that is not currently depicted upon the leak survey map; they should identify this location for additional evaluation. The surveyor should document as follows:
 - 6.4.1. The surveyor should circle the land parcel that potentially has triggered the business district and denote the following on the map cover sheet:
 - 6.4.2. Select the checkbox identifying a potential business district was identified.

Leakage Surveys	SCG:	223.0100
------------------------	-------------	-----------------

6.4.3. In the Comment Section of the Map Coversheet, describe the land use of the parcel that should be evaluated for meeting the business district designation (i.e. business, hospital, school, church, a significant commercial gathering point).

6.4.4. Return the completed survey map and comments to Asset Maintenance & Inspection for processing.

7. ABNORMAL OPERATING CONDITIONS

7.1. Issue orders for investigation and correction when any abnormal conditions (see [STANDARD 167.0100](#), “*Operator Qualification Program*”, Appendix B, ABNORMAL OPERATING CONDITIONS) or when the following conditions, but not limited to, are encountered:

7.1.1. Meters in prohibited or hazardous meter locations, damaged, or corroded meter sets and meters buried in earth or paving.

7.1.2. Regulators in confined areas not vented to a safe location.

7.1.3. Broken or missing curb meter vault or curb valve lids.

7.1.4. Service cocks not readily accessible or otherwise inoperable.

7.1.5. Pipe (including services) having buildings constructed over them.

7.1.6. Pipe (including services) that are endangered by foreign construction.

7.1.7. Curb valves not readily accessible on services to schools, hospitals or churches.

7.1.8. Exposed piping showing evidence of atmospheric corrosion, chemical corrosion and other conditions that warrant concern.

7.1.9. Stress on exposed piping facilities as a result of earth movement or other causes.

7.1.10. Missing, broken and damaged casing vents.

**Company Operations Standard
Gas Standard
Gas Operations & System Integrity**

Leakage Surveys	SCG:	223.0100
------------------------	-------------	-----------------

8. EVALUATION OF LEAKAGE

- 8.1. The **responsible employee** or **supervisor** reviews all leak indications found and assigns an appropriate leakage priority classification based on potential hazard. See **GAS STANDARD 223.0125**, *Leakage Classification and Mitigation Schedules*.
- 8.2. Any leak indication that is investigated and presumed to be from another SoCalGas Business Unit (i.e. Transmission, Distribution or Storage) should be reported to the appropriate business unit in a timely manner.
- 8.3. When a Gas **Transmission District** or **Storage Field** detects leakage on a **Distribution Region** facility, obtain the **Region's** appropriate leak order number. Record the number on **Form 677-1**, *Pipeline Condition and Maintenance Report*, and on the leak survey inspection record.
- 8.4. When a **Distribution Region** detects leakage on a **Gas Transmission District** or **Storage Field** facility, the appropriate **Gas Transmission District** or **Storage Field** is contacted. The **Gas Transmission District** or **Storage Field** provides the reporting **Region** with the applicable **Form 677-1** number.
- 8.5. The survey person will confirm any leak indication with a combustible gas indicator (CGI); see **GAS STANDARD 107.0287**, *GMI Gasurveyor – Combustible Gas Indicator (CGI)* and **GAS STANDARD 107.0294**, *DP-IR Heath Detecto Pak-Infrared®*.
- 8.6. To code a leak when the DPIR Unit is used as a CGI the “sustained” read has to be at a detectable level, meaning the read has to be 5000 PPM with the DPIR or one-half percent or more with the GMI Gasurveyor – Combustible Gas Indicator (CGI).
- 8.7. If the leak indication is located under street or paving, a hole must be drilled to take the read.
- 8.8. When leak indications are suspected to be from field or swamp gas per **GAS STANDARD 184.0220**, *Field Gas*, the responsible supervisor contacts the Engineering Analysis Center (EAC).
- 8.9. Leak indications found in small gas associated substructures, such as but not limited to small curb meter boxes or gas valve boxes / valve casings and **not** in the surrounding soil must be reported. Issue an order (form 4040) to code the leak in the small gas associated substructure:
 - 8.9.1. Code leaks accordingly to indications and situations that are found per **GAS STANDARD 223.0125**, *Leak Classification and Mitigation*.

Leakage Surveys	SCG:	223.0100
-----------------	------	----------

9. REPORTING

- 9.1. When a suspected safety-related condition is found, report it to the immediate supervisor the same day the condition is discovered.
- 9.2. Report all leaks and corrosion on **DOT-T Transmission lines** as outlined in **GAS STANDARD 183.06**, *“Region Reports of Safety-Related Pipeline Conditions.”*
- 9.3. To ensure a safe response, communicate emergency incident as outlined in **GAS STANDARD 183.03**, *Field Guidelines – Emergency Incident Distribution / Customer Service* or **GAS STANDARD 183.0110**, *Field Procedures- Emergency Incidents-Transmission*.

10. RECORDS

- 10.1. Gas Transmission District and Storage Operations
 - 10.1.1. Document all leak indications and leak repairs on [Form 677-1](#), Pipeline Condition and Maintenance Report (Transmission and Storage).
 - 10.1.2. Schedule, track, and document all routine leakage surveys in an approved computerized maintenance management system (MAXIMO).
- 10.2. Distribution Regions
 - 10.2.1. Documentation of the Leak Survey
 - 10.2.1.1. Leak surveyor will document the completion of a leak survey on the leak survey order in the Mobile Data Terminal (MDT).
 - 10.2.1.2. The leak surveyor performing the leak survey is also provided with maps of the areas to be surveyed. The Maps used for survey will depict pipeline location to be surveyed and the surrounding streets.
 - 10.2.1.3. The leak surveyor is required to bracket the completed area(s) they surveyed for that day on the map using a blue pen. It is also required for them to include their initials and the date the survey was performed on each pipeline segment.
 - 10.2.1.4. All below ground leaks are noted in red and marked with an “X”, tallied on the Leak Survey Map Cover Sheet and:

Leakage Surveys	SCG:	223.0100
------------------------	-------------	-----------------

- New below ground leaks are identified using the location (sequence) number.
- Existing leaks are verified using the “Shop Papers” under the “Attachments” tab within the Leak Survey Order. Once verified, existing leaks are identified with the Equipment number.

10.2.1.5. If leakage spread is twenty (20) feet or more use dotted red line to indicate spread on map.

10.2.2. Documentation of Leak Investigation

10.2.2.1. Leak investigations are documented on a leak investigation order (Form 4030) which available on the MDT.

10.2.2.2. Form 4030 is used with the Maintenance Activity Type of “Recheck Leak” for recheck of underground leakage after repair.

10.2.2.3. Report all leaks and corrosion on transmission lines as outlined in **GAS STANDARD 183.06**, *Region Reports of Safety-Related Pipeline Conditions*.

11. RECORDS RETENTION

11.1. Records covering leakage surveys, leaks discovered, and repairs made on distribution pipelines are documented using SAP and maintained for the life of the pipeline plus six years.

11.2. Records covering leakage surveys, leaks discovered, and repairs made on transmission pipelines are documented using an approved computerized maintenance management system (e. g., MAXIMO or SAP) and filed by the appropriate **Gas Transmission District, Storage Field, or Distribution Region**, and must be retained per Records Management Retention Schedule. See Records Retention Standards on Sempra Net, <http://home.sempranet.com/rm/>.



Company Operations Standard Gas Standard Gas Operations & System Integrity

Leakage Surveys	SCG:	223.0100
-----------------	------	----------

11.2.1. In addition to the other recordkeeping requirements of these rules, each Operator shall maintain the following records for transmission lines for the periods specified:

- A. The date, location, and description of each repair made to pipe (including pipe-to-pipe connections) must be retained for as long as the pipeline remains in service or there is no longer pipe within the system of the same manufacturer, size and / or vintage as the pipeline on which repairs are made, whichever, is longer.
- B. The date, location, and description of each repair made to parts of the pipeline system other than pipe must be retained for at least 75 years. Repairs or findings of easement encroachments, generated by patrols, surveys, inspections, or tests required by subparts L and M of 49 CFR Part 192 must be retained in accordance with paragraph (c) of this section.
- C. A record of each patrol, survey, inspection, and test required by subparts L and M of this part must be retained for at least 75 years.

12. OPERATOR QUALIFICATION COVERED TASKS

(See [STANDARD 167.0100](#), *Operator Qualification Program*, Appendix A, *Covered Task List*)

Task 09.01. – 49 CFR 192.706 – Performing leakage surveys: transmission lines

Task 09.02 - 49 CFR 192.723 – Performing leakage surveys: distribution systems

Task 02.13 - 49 CFR 192.481 – Monitoring for atmospheric corrosion



Attachment K
Company Operations Standard
Gas Standard
Gas Operations & System Integrity

Leakage Surveys	SCG:	223.0100
------------------------	-------------	-----------------

NOTE: Do not alter or add any content from this page down; the following content is automatically generated.

Brief: There were no changes to the duties performed. The Policy was revised for clarity and to meet the requirements contained in GO 112 F. Reformatted to comply with document outline requirements. Section 4 Procedure: Revised Table 1 Leakage Survey Frequencies to meet GO 112F leakage survey requirements. Revised section 4.4 "High Pressure Pipelines (Operating over 60 Psig) not including DOT-Transmission Pipelines" Revised section 4.5.1 "Non-HCA Transmission Pipeline Segments in Location Class 3* and all DOT-T pipe not covered in Section 4.5.2.1 and 4.5.2.2. Section 5, APPLICATION OF LEAK SURVEY METHODS: Revised Table 3 ground patrol was removed from the approved method table. Revised 5.2.1- by removing "such as, but not limited to those" when referring to approved leak survey instruments. Regulatory change Section 5.2.5.5 -Added "Note: When casing vents are presents they must be inspected to ensure they are in satisfactory condition and designed to prevent entry of water, insects, and other foreign matter. Vents should extend at least four feet above finished grade and at least four feet below overhead electric wires. Vents shall be located in an area away from traffic and other hazardous locations". Revised Section 5.2.5.6 - Added "Note:When a service enters a building (basement, underground parking facility, enclosed structure etc.) attempt to gain safe entry and survey the portion of the service that can be surveyed inside the building up to the riser including meter set assemblies. If unable to access these types of locations while performing leakage survey, follow guidelines in Section 5.2.5.6 above". Numbering change section 5.5 Barhole is now 5.4. Section 5.6 5.6. WATER CROSSING is now section 5.5. Regulatory Change- Added section 7.1.10 - Missing, broken and damaged casing vents. GO 112F Record retention requirements revisions made to section 11.1-

Records covering leakage surveys, leaks discovered, and repairs made on distribution pipelines are documented using SAP and maintained for the life of the pipeline plus six years. Section 11.2 - Records covering leakage surveys, leaks discovered, and repairs made on transmission pipelines are documented using an approved computerized maintenance management system (e. g., MAXIMO or SAP) and filed by the appropriate Gas Transmission District, Storage Field, or Distribution Region, and maintained for the life of the pipeline plus five years or 75 years, whichever is longer.

Document Profile Summary	
Responsible Person:	██████████
Published On:	12/19/2016
Last Full Review Completed On:	12/19/2016
Writer:	██████████
Document Status:	Active
Document Type:	GAS
Category (Prior FCD system only):	
If Merged, Merged To Document Number:	
Utility:	SoCalGas
Department:	Gas Operations & System Integrity
Number of Common Document (if applicable):	G8145
Contains OPQUAL Covered Task:	Yes
Part of SoCalGas O&M Plan:	Yes
Part of SDG&E O&M Plan:	No
Last O&M Review date:	2017-11-29
O&M 49 CFR Codes & Impacted Sections of Document:	192.723: Entire Doc 192.721(a): Entire Doc 192.709(c): Entire Doc 192.709(b): Entire Doc 192.709(a): Entire Doc 192.706: Entire Doc 192.613(a): Entire Doc 192.481(a): 7, 8, 9, 10
Part of Non-O&M Parts 191-193 Plan	No
Non-O&M 49 CFR Codes & Impacted Sections of Document	



**Company Operations Standard
Gas Standard
Gas Operations & System Integrity**

Leakage Surveys	SCG:	223.0100
------------------------	-------------	-----------------

Part of Distribution IMP (DIMP)	Yes
Part of Transmission IMP (TIMP)	Yes
Part of Storage IMP (SIMP)	No
Impacts GO112F	Yes
GO112F Codes & Impacted Sections of Document	145.1: (a)10, 11, (b)10, 11, (c)8, 9, 10, 11 143.1: Entire Document
Impacts GO58A	No
GO58A Codes & Impacted Sections of Document	
Impacts GO58B	No
GO58B Codes & Impacted Sections of Document	
Indices/Binders in Which Document is Filed:	TRAN, TIMP2, STOR, LSDP, DISTM, DIMP2
NOP Learning Module (LM) Training Code:	NOP00604

INTERNAL



Company Operations Standard Gas Operations

Scheduling Distribution Tests and Inspections	SCG:	184.0005
---	------	----------

PURPOSE To define and establish the anniversary month(s) for inspections, tests, surveys, and patrols required by Code of Federal Regulations 49 and G.O. 112-F.

1. SCOPE

- 1.1. Anniversary months are required in order to have a starting date for all inspections, tests, surveys, and patrols. Once a starting date is established, all future cycles (annual, semi-annual, quarterly, etc.) for inspections, tests, surveys, and patrols can be scheduled and tracked to assure proper completion dates.
- 1.2. Five-year, ~~three-year~~, and annual routine Leak Survey anniversary months are February thru ~~September~~ November.

2. RESPONSIBILITIES

- 2.1. **Region Asset Maintenance and Inspection** is responsible for establishing anniversary months.

3. DEFINITIONS

- 3.1. **Anniversary:** means a calendar month at which time a periodic inspection, test, patrol, or other activity must be conducted. The anniversary is in the same month(s) every year except as provided in paragraph 4.7.1.

4. PROCEDURE

4.1. Five-Year Inspections

- 4.1.1. Five-year inspections must be completed at least once every 5 calendar years at intervals not exceeding 63 months starting from the established anniversary month.

~~4.2. Three Year Inspections~~

- ~~4.2.1. Three-year inspections must be completed at least once every 3 calendar years at intervals not exceeding 39 months starting from the established anniversary month.~~

4.3. Annual Inspections

- 4.3.1. Annual inspections must be completed during a period from the month preceding to the month following the established anniversary month, except that inspections must be completed once during each calendar year.



Company Operations Standard Gas Operations

Scheduling Distribution Tests and Inspections	SCG:	184.0005
--	-------------	-----------------

Examples:

- The last inspection was completed on January 14, 2016 (January is established as the anniversary month). The next inspection must be performed between January 1, 2017, and February 28, 2017.
- The last inspection was completed July 10, 2016. The next inspection must be performed between June 1, 2017, and August 31, 2017.
- The last inspection was performed on December 12, 2016. The next inspection must be performed between November 1, 2017, and December 31, 2017.

4.4. Semi-Annual Inspections

- 4.4.1. Inspections required to be performed twice each calendar year must be completed within the same two calendar months each year starting from the established anniversary month.

Example:

- Inspections were completed on April 12, 2016, and October 5, 2016. Inspections for 2017 must be performed any time during the months of April and October and in each subsequent year thereafter.

4.5. Quarterly Inspections

- 4.5.1. Inspections required to be completed quarterly during each calendar year must be completed during the same four calendar months each year starting from the established anniversary month.

Example:

- Inspections were completed on February 24, 2016; May 20, 2016; August 19, 2016; and November 2, 2016. Inspections for 2017 must be performed anytime during February, May, August, and November and in each subsequent year thereafter.

4.6. Bi-Monthly Inspections

- 4.6.1. Inspections required to be performed on a two-month basis are scheduled within the same anniversary month each year but with intervals not exceeding two and one-half months (75 days).

Example:



Company Operations Standard Gas Operations

Scheduling Distribution Tests and Inspections	SCG:	184.0005
---	------	----------

- Inspections were completed during 2016 on January 20, March 18, May 16, July 14, September 12, and November 5. Inspections for 2017 are scheduled to be performed during the same calendar months with intervals not exceeding two and one-half months (75 days).
- Assuming the first 2017 inspection is completed on January 10, the March inspection must be completed during March 1 - 25.
- Assuming a completion date of March 8, the May inspection must be performed during May 1 - 22.
- Assuming a completion date of May 20, the July inspection must be performed during July 1 - 31.

4.7. Changes to anniversary months

4.7.1. **Regions** may elect to have earlier anniversary months. If an anniversary is moved back to an earlier month, all future anniversaries for this specific periodic test, inspection, or other activity will be moved back correspondingly.

4.7.2. **Regions** may, in the course of their operations or maintenance, perform tests, inspections, or other activities at times other than within the specified periods; however, this will not be considered compliance and does not relieve **Regions** of the requirement to perform such activities within the specified periods.

5. RECORDS

5.1. Not Applicable



Company Operations Standard Gas Operations

Scheduling Distribution Tests and Inspections	SCG:	184.0005
--	-------------	-----------------

NOTE: Do not alter or add any content from this page down; the following content is automatically generated.

Brief: Policy was revised there were no changes to the duties performed. Reformatted to comply with document outline requirements. Revisions made to Purpose, revised reference to GO 112-F. Section 2.RESPONSIBILITIES. 2.1 replace Technical Services with Region Asset Maintenance and Inspection. Section 4. PROCEDURE, updated dates used in examples with current dates.

Document Profile Summary	
Responsible Person:	[REDACTED]
Published On:	03/30/2017
Last Full Review Completed On:	03/30/2017
Writer:	[REDACTED]
Document Status:	Active
Document Type:	STAND
Category (Prior FCD system only):	
If Merged, Merged To Document Number:	
Utility:	SoCalGas
Department:	Staff & Technical Services
Number of Common Document (if applicable):	
Contains OPQUAL Covered Task:	No
Part of SoCalGas O&M Plan:	No
Part of SDG&E O&M Plan:	No
Last O&M Review date:	
O&M 49 CFR Codes & Impacted Sections of Document:	
Part of Non-O&M Parts 191-193 Plan	No
Non-O&M 49 CFR Codes & Impacted Sections of Document	
Part of Distribution IMP (DIMP)	No
Part of Transmission IMP (TIMP)	No
Impacts GO112F	No
GO112F Codes & Impacted Sections of Document	
Impacts GO58A	No
GO58A Codes & Impacted Sections of Document	
Impacts GO58B	No
GO58B Codes & Impacted Sections of Document	
Indices/Binders in Which Document is Filed:	DISTM
NOP Learning Module (LM) Training Code:	NOP00288

CALIFORNIA ENERGY COMMISSION

1516 NINTH STREET
SACRAMENTO, CA 95814-5512
www.energy.ca.gov

**NOTICE OF PROPOSED AWARDS (NOPA)**

**Enhancing Safety, Environmental Performance, and Resilience of California's
Natural Gas System
GFO-17-502
February 6, 2018**

On September 11, 2017, the California Energy Commission (Energy Commission) released a competitive solicitation to fund Applied Research and Development (AR&D) projects that develop innovative methods to protect natural gas infrastructure; enhance features of the next-generation version of Cal-Adapt; improve life cycle accounting for imported natural gas; increase cost effectiveness of methane leak detection; and identify building stock in disadvantaged communities that would benefit the most from retrofitting activities. Up to \$8.9 million of Natural Gas Research Program funding is available to fund applications in five project groups:

- **Group 1:** Exploratory Study of Innovative Methods to Assess Structural Integrity of Levees Protecting Natural Gas Infrastructure in the Sacramento-San Joaquin Delta
- **Group 2:** Developing Next-Generation Cal-Adapt Features to Support Natural Gas Sector Resilience
- **Group 3:** Chemical and Isotopic Fingerprints of Natural Gas Basins to Support Full Fuel Cycle Accounting
- **Group 4:** Field Study to Identify and Mitigate Methane Emissions in the Southern Part of the San Joaquin Valley
- **Group 5:** Identification of Potential Retrofit Opportunities of Buildings in Disadvantaged Communities in an Urban Area in the San Joaquin Valley

The Energy Commission received nine proposals for Groups 1, 2, 3, and 4 by the due date of November 17, 2017. No applications were received under Group 5. All submitted proposals passed the Stage One Application Screening. All passing proposals were screened, reviewed, evaluated, and scored according to the solicitation's criteria.

The attached "Notice of Proposed Awards" identifies each applicant selected and recommended for funding by Energy Commission staff under Groups 1, 2, 3, and 4 respectively and includes the recommended funding amount and score. The total amount recommended for Groups 1 through 4 is \$8,849,978.

Funding of proposed projects resulting from this solicitation is contingent upon the approval of these projects at a publicly noticed Energy Commission business meeting and execution of a grant agreement. If the Energy Commission is unable to timely negotiate and execute a funding agreement with an Applicant, the Energy Commission, at its sole discretion, reserves the right to cancel or otherwise modify the pending award, and award the funds to another applicant.

In addition, the Energy Commission reserves the right to add to, remove, or shift funding to make additional awards; negotiate with successful applicants to modify the project scope, schedule, and level of funding.

This notice is being mailed to all parties who submitted an application to this solicitation and is also posted on the Energy Commission's website at www.energy.ca.gov/contracts/.

For information, please contact Commission Agreement Officer Andrea Hoppe at (916) 651-0588 or andrea.hoppe@energy.ca.gov.



California Energy Commission GFO-17-502

Enhancing Safety, Environmental Performance, and Resilience of California's Natural Gas System

Notice of Proposed Awards

Project Group 1: Exploratory Study of Innovative Methods to Assess Structural Integrity of Levees Protecting
Natural Gas Infrastructure in the Sacramento-San Joaquin Delta

2/6/18

Rank Number	Project Applicant	Title	Energy Commission Funds Requested	Energy Commission Funds Recommended	Match Funds	Score	Award Status
Proposed Awards							
1	Infraterra, Inc.	Development of an Integrated Methodology for Assessing Integrity of Levees Protecting Natural Gas Infrastructure	\$550,000	\$550,000	\$0	88.9	Awardee
Passed But Not Funded							
2	Institute of Gas Technology	Field Testing of Non-Invasive Levee Assessment Methods	\$550,000	\$0	\$41,350	78.8	Finalist
Grand Total			\$1,100,000	\$550,000	\$41,350		



California Energy Commission GFO-17-502

Enhancing Safety, Environmental Performance, and Resilience of California's Natural Gas System

Notice of Proposed Awards

Project Group 2: Developing Next-Generation Cal-Adapt Features to Support Natural Gas Sector Resilience

2/6/18

Rank Number	Project Applicant	Title	Energy Commission Funds Requested	Energy Commission Funds Recommended	Match Funds	Score	Award Status
Proposed Awards							
1	The Regents of the University of California, Berkeley	Developing Next-Generation Cal-Adapt Features to Support Natural Gas Sector Resilience	\$1,200,000	\$1,000,000	\$0	87.9	Awardee
2	Eagle Rock Analytics	Developing Next-Generation Cal-Adapt Features to Support Natural Gas Sector Resilience	\$1,200,000	\$200,000	\$0	84.1	Awardee
Grand Total			\$2,400,000	\$1,200,000	\$0		



California Energy Commission GFO-17-502

Enhancing Safety, Environmental Performance, and Resilience of California's Natural Gas System

Notice of Proposed Awards

Project Group 3: Chemical and Isotopic Fingerprints of Natural Gas Basins to Support Full Fuel Cycle Accounting

2/6/18

Rank Number	Project Applicant	Title	Energy Commission Funds Requested	Energy Commission Funds Recommended	Match Funds	Score	Award Status
Proposed Awards							
1	Lawrence Berkeley National Laboratory	Chemical and Isotopic Analyses to Improve Life-Cycle Assessments of Natural Gas Consumed in California	\$549,978	\$549,978	\$53,633	78.01	Awardee
2	The Regents of the University of California, Irvine	Chemical and Isotopic Fingerprinting Technique to Determine Composition of Natural Gas Consumed in California	\$550,000	\$550,000	\$84,989	73.7	Awardee
Subtotal			\$1,099,978	\$1,099,978	\$138,622		
Did Not Pass							
	GeoMechanics Technologies	Advanced Geochemical Analysis of Consumed and Sourced Natural Gas to Quantify Greenhouse Gas Emissions by Basin	\$546,105	\$0	\$45,150		Did Not Pass
Grand Total			\$1,646,083	\$1,099,978	\$183,772		



California Energy Commission GFO-17-502

Enhancing Safety, Environmental Performance, and Resilience of California's Natural Gas System

Notice of Proposed Awards

Project Group 4: Field Study to Identify and Mitigate Methane Emissions in the Southern Part of the San Joaquin Valley

2/6/18

Rank Number	Project Applicant	Title	Energy Commission Funds Requested	Energy Commission Funds Recommended	Match Funds	Score	Award Status
Proposed Awards							
1	Lawrence Berkeley National Laboratory	SUper EMitters of Methane Detection Using Aircraft, Towers, and Intensive Observational Network (SUMMATION)	\$6,000,000	\$6,000,000	\$14,425,970	96.1	Awardee
Subtotal			\$6,000,000	\$6,000,000	\$14,425,970		
Passed But Not Funded							
2	The Regents of the University of California, Davis	Measurement, Characterization and Mitigation Strategies for Methane Emissions in the Southern San Joaquin Valley	\$5,979,755	\$0	\$650,000	83.2	Finalist
Grand Total			\$11,979,755	\$6,000,000	\$15,075,970		



California Energy Commission GFO-17-502

Enhancing Safety, Environmental Performance, and Resilience of California's Natural Gas System

Notice of Proposed Awards

Project Group 5: Identification of Potential Retrofit Opportunities of Buildings in
Disadvantaged Communities in an Urban Area in the San Joaquin Valley

2/6/18

Rank Number	Project Applicant	Title	Energy Commission Funds Requested	Energy Commission Funds Recommended	Match Funds	Score	Award Status
No proposals were received for this group.							

Southern California Gas Company

Research, Development, and Demonstration Program

2017 Annual Report
Highlighting 2016 activities



SCG 2017 Annual RD&D Report

Table of Contents

1.	Executive Summary	- 2 -
2.	Program Highlights & Accomplishments	- 8 -
3.	Financial Summary	135
4.	Royalties and Equity Investments	157
5.	Customer Applications	168
	Customer End Use Applications	168
	Clean Generation.....	1921
	Clean Transportation	224
6.	Gas Operations.....	257
	Environmental & Safety	257
	Operations Technologies.....	268
	System Design & Materials.....	268
	System Inspection & Monitoring	268
7.	Low Carbon Resources	279
	Biomass Gasification	279
	Poer-to-Gas (P2G):.....	30
	Carbon Capture and Utilization.....	30
	Low Carbon Hydrogen from Methane.....	30
8.	Program Wide Partnership.....	30
	Appendix A – Customer Applications	35
	Appendix B – Gas Operations	53
	Appendix C – Low Carbon Resources.....	83
	Appendix D – Program Wide Partnership.....	95

1. Executive Summary

Southern California Gas Company (SCG) has a successful history conducting Research, Development, and Demonstration (RD&D) activities to advance technologies and products that promote safety, resiliency and reliability of the natural gas infrastructure, energy efficiency and environmental benefits.

The RD&D Program was formalized in the 1980's, through the California Public Utility Commission's (CPUC) Decision D.82-12-05, and has been re-authorized in each subsequent rate case. SCG's General Rate Case D.16.06.054, for the period covering 2016-2018 is the most recent. Because of the consistent support and funding authorized by the CPUC for this program, SCG is an industry leader in RD&D. We have introduced and developed new and advanced technologies that benefit ratepayers for operational and environmental advances.

SCG RD&D program generates ratepayer benefits by developing and demonstrating advanced technologies that create environmental and energy efficiency benefits related to the use of natural gas and operational improvements such as enhanced safety and reliability.

This 2017 RD&D Annual Report highlights the activities from 2016 and outlines longer term research strategies and priorities.

Federal and State Policies, Mandates, Regulations, and Goals

Policies and regulations play an important role in defining RD&D targets and activities. These targets and activities benefit ratepayers in areas such as energy efficiency, low- carbon technologies, air emissions, and gas operations safety, resiliency and reliability. Specifically, projects selected and pursued in SCG's RD&D Program are driven by the following key directives:

- **California's Loading Order**, which establishes **energy efficiency** as the most preferred resource and makes explicit the preference for renewable resources and clean natural gas resources. California continues to pursue ambitious energy efficiency goals. Specifically, CPUC energy efficiency program goals (D.12-11-015) required a reduction of natural gas consumption by 27.15 million therms per year for 2016 and similar targets for subsequent years. Activities in the RD&D program supplement and support activities funded through the energy efficiency program in areas such as gas-fired distributed generation, appliances and industrial processes.
- The **Federal Clean Air Act**, which requires **compliance with emissions standards** for 8-hour ozone and 2.5 PM (particulate matter up to 2.5 microns in size), resulting in a need to further reduce emissions of nitrogen oxides (NOx) by 50% by 2023. The National Ambient Air Quality Standards (NAAQS), under the Federal Clean Air Act (CAA), requires substantially lower fine particulate (PM2.5) and NOx emissions to meet the 8-hour surface-level ozone standard. These new standards require Southern California to

significantly accelerate its criteria pollution reduction efforts over the next decade. Meeting the standards will require reduction of NO_x emissions of 50% or more in the South Coast Air Quality Management District (SCAQMD) and San Joaquin Valley Air Pollution Control District (SJVAPCD) by 2023 and 65% by 2031. Technology advancement in combustion science and after treatment is critical to meeting these goals.

- **Zero Net Energy (ZNE):** The 2013 Integrated Energy Policy Report (IEPR) recommended triennial building standards updates that increase the energy efficiency of newly constructed buildings by 20 to 30% in every triennial update to achieve ZNE standards for low-rise residential buildings by 2020 and commercial buildings in 2030. Development of efficient natural gas technologies to support local energy production can serve a critical role in meeting this goal, particularly considering the intermittent nature of photovoltaic generation and emerging, more cost-effective on-site generation technology.
- **Indoor air quality:** RD&D projects which address indoor air quality issues include development of new technologies that reduce formaldehyde, NO_x, CO and Volatile Organic Compounds inside homes and businesses. One specific area of focus is with unvented gas-fired kitchen appliances.
- **California's Global Warming Solutions Act**, Assembly Bill (AB) 32, which requires the reduction of state greenhouse gas (GHG) directs the California Air Resources Board (CARB) to develop plans to reduce GHG emissions to 1990 levels by 2020 and Executive Order S-03-05 sets the targets for California to reduce GHG emissions by 50% by 2030 and an 80% reduction relative to 1990 levels by 2050. SB 1371 specifically directs the CPUC to develop and implement a comprehensive natural gas pipeline leak reduction strategy that ensures that companies identify and quickly and efficiently repair methane leaks consistent with established safety requirements and the goals of reducing climate change impacts from methane emissions. Meeting these targets requires dramatic advances in technology to reduce GHG post combustion products and efficiently prioritize leak repairs.
- California's **Renewable Portfolio Standards**, which require 33% of all power generation to come from renewable sources by 2020; and 50% by 2030. **The California Solar Thermal Initiative:** CPUC decisions 13-02-018 and 13-08-004 affirm their commitment towards expansion of solar thermal technologies and establish incentives for solar thermal applications for process heating, solar cooling, space heating and solar pool systems. Significant technology advancement is needed to improve the cost and performance of these technologies.

- **Power-to-Gas:** The need for energy storage is becoming significant in California and other locations with high renewables penetration and high amounts of distributed generation. Gaseous fuels (hydrogen and methane) offer storage functionality like compressed air and pumped hydro and associated technologies (e.g. electrolyzers) can serve multiple grid functions. SoCalGas is active in expanding this potential through its own RD&D program as well as the Hydrogen Energy Storage Committee of the California Hydrogen Business Council.
- Governor's Executive Order S-06-06, which calls for increased production and use of biofuels made from in-state resources. The CEC's 2012 **Bioenergy Action Plan** outlines strategies, goals, objectives, and actions that California state agencies will take to increase bioenergy development in California. The 2012 Bioenergy Action Plan states that the bioenergy market is underdeveloped and that "despite its many benefits, bioenergy production uses only 15% of California's available biomass waste and production is decreasing." Executive Order S-06-06 also established a goal to produce 20% of renewable electricity from biofuels by 2020.
- **Low Carbon Fuel Standards:** California's Alternative Fuels legislation (AB 118), which requires increasing the use of alternative fuels consistent with California mandates. California law requires increased use of alternative transportation fuels and Executive Order S-01-07's establishes a state-wide goal to reduce the carbon intensity of California's transportation fuels by at least 10% by 2020 and reduce petroleum fuel use to 15% below 2003 levels by 2020.
- **Pipeline Safety Regulations** codified in California Public Utility Commission's General Order 112F and US Department of Transportation/PHMSA's Code of Federal Regulations 42 Part 192 pipeline maintenance and safety regulations. AB 1900 established new or enhanced natural gas pipeline safety and reliability standards, and biomethane gas quality requirements. SCG's planned RD&D supports advancement of technologies that enhance the safety and reliability of the natural gas system in the areas of inspection, monitoring, quality control and construction. Examples include leak detection systems, gas quality assessment, pipeline material tracking and traceability, pipeline and ground movement detection sensors and internal robotic inspection technologies.

RD&D Programs Summaries

The RD&D Program consists of four major areas: Customer Solutions, Gas Operations, Low Carbon Resources and Program Wide Partnership.

Table 1 shows the programs and sub-programs within the RD&D program.

RD&D Programs	Sub-Programs
Customer Applications	Customer End Use Applications
	Clean Generation
	Clean Transportation
Gas Operations	Environmental and Safety
	Operations Technologies
	System Design and Materials
	System Inspection and Monitoring
Low Carbon Resources	Biomass Gasification
	Power-to-Gas
	Artificial Photosynthesis
	Carbon Capture, Utilization, and Sequestration
	Low Carbon Hydrogen from Methane
Program Wide Partnership	Program Wide Partnership

Customer Applications

The Customer Solutions RD&D program consists of three sub-program areas: Customer End Use Applications, Clean Generation & Clean Transportation.

Customer End Use Applications

SoCalGas' Customer End Use Applications RD&D focuses on developing, demonstrating and commercializing technologies that cost-effectively improve the efficiency and reduce the environmental impacts of natural gas end-use equipment. SoCalGas pursued projects that are focused on the development and demonstration of next-generation condensing water and space-heating appliances, gas heat pumps, solar thermal systems for water heating, space conditioning, clothes drying, commercial cooking and industrial boilers and process heaters. Underlying technology elements of focus include improved burner and combustion systems for NOx control, thermal management, improved materials, control systems, and reduce equipment first cost.

Clean Generation

SoCalGas' Clean Generation RD&D program focuses on supporting the development and demonstration of high-efficiency, low-emissions CHP systems for the residential, commercial, and industrial market segments within the SoCalGas service territory. This program support development and market introduction of low-emission, distributed

generation technologies working with equipment providers developing emissions control technologies, improving total system efficiency and lowering the cost of CHP and other natural gas distributed generation solutions that meet the unique environmental requirements of southern California. Clean Generation RD&D activities include: small-scale CHP systems featuring advanced emission control systems capable of meeting current and future AQMD NO_x limits; fuel cell systems demonstrating improved efficiency, performance and reliability; and smaller residential scale systems. Systems for recovering waste heat and those using alternative thermal cycles, such as Stirling cycle, free-piston engine, and rotary engines, with the potential for improved efficiency and low cost will be pursued.

Clean Transportation

SoCalGas' Clean Transportation RD&D activities focuses on minimizing the environmental impacts related to the use of natural gas as a transportation fuel and on reducing the cost of natural gas transportation. California's transportation sector, having one of the nation's largest transportation infrastructures to support its demand, is subjected to the most stringent emissions standards in the nation. As set forth by the EPA, CARB, and SCAQMD, emissions standards are being reduced to the lowest levels the industry has seen and across the nation. Companies and entities operating on/off-road vehicles within the boundaries of both the South Coast Air Quality Management District (SCAQMD) and the San Joaquin Valley Air Pollution Control District (SJVAPCD) must adhere to the new emissions regulations to improve air quality to protect and propagate a cleaner environment for public health, by a certain time frame/period. Specific areas of SoCalGas development and demonstration support include engine control and after-treatment systems to reduce emissions, engine and drive-line efficiency improvements (such as air-fuel systems and hybrid drive), cost reduction for fueling infrastructure and on-board natural gas storage tanks, and synergies between natural gas and hydrogen transportation and infrastructure technologies.

Gas Operations

SoCalGas' Gas Operations RD&D activities focus on the development of new technologies that help SCG enhance pipeline (public) and employee safety, improve operating efficiency and reliability, meet regulatory mandates, reduce GHG emissions, and ensure gas quality of renewable resources is compatible with the infrastructure. The suite of projects under development are performed primarily through In-House research, Universities, and collaborative research organizations such as Sustaining Membership Program, Operations Technology Development, NGA/NYSEARCH and Pipeline Research Council International. The program is comprised of four sub-program areas: 1) Environmental & Safety, 2) Operations Technologies, 3) System Design & Materials, and 4) System Inspection & Monitoring.

Low Carbon Resources

SoCalGas' Low Carbon Resources RD&D activities focuses on the development and commercialization of technologies that cost-effectively decarbonize the natural gas supply chain through the development of renewable natural gas resources, energy conversion technologies and carbon capture, use and sequestration technologies. SoCalGas' Low Carbon Resources RD&D activities seek to support the development and deployment of technologies across the natural gas supply chain that cost effectively enhance energy reliability and sustainability, improve local air quality, and reduce greenhouse gas (GHG) emissions. This program is divided into five sub-program areas: 1) Biomass Gasification, 2) Power-to-Gas, 3) Artificial Photosynthesis, 4) Carbon Capture and Utilization, and 5) Low Carbon Hydrogen from Methane.

Program Wide Partnership

SoCalGas' Program Wide Partnership RD&D activities focuses on collaboration with many governmental and private organizations to fund research development and demonstration projects of mutual interest. These collaborative RDD efforts provide significant financial benefits through cost sharing while also increasing the probability of technical and commercial success by tapping into the collective wisdom and experience of all participating organizations. Key organizations are: Department of Energy, California Energy Commission, Utilization Technology Development, Sustaining Membership Program, Operations Technology Development, Pipeline Research Council International, NGA/NYSEARCH, National Labs and Universities, and University Outreach.

2. Program Highlights & Accomplishments

Customer Applications



> Zero Net Energy Assessment

Evaluated how several baseline mixed-fuel and electric-only homes could cost-effectively reach ZNE goals through an optimized suite of advanced building technologies. Key findings in this assessment showed that mixed-fuel ZNE homes have several advantages over electric-only ZNE designs in most location/home size combinations, including: smaller PV system size, lower incremental costs, and higher Total Resource Cost (TRC) values. In 2016, the model was updated with improved appliance cost data and with new TVD values.



> Effects of Biogas on Commercial Cooking Equipment

This Study investigates the effects of reducing the Rule 30 Higher Heating Value (HHV) lower limit of 990 Btu/scf to 974 Btu/scf (biogas) on commercial natural gas cooking equipment. In 2016, testing was completed on fryers, underfired charbroilers, convection ovens and griddles. Tests results indicate that reducing the lower heating value of gas to 974 Btu/scf will not create a safety concern for commercial cooking equipment.

> Demo of Ribbon Burner

Developed various process heater ribbon burner designs that meet NO_x emission targets ranging from 20 to 60 ppm depending on process temperature. In 2016, GTI and Flynn Burner Company completed the design and ordered all the materials for the demonstration project. A full-scale demonstration of this ribbon burner technology will be initiated in 2017 on an industrial baking oven at Western Bagel in Van Nuys, California.



> Ultra Low NO_x Boiler

Demonstrate a novel Ultra-Low NO_x (ULN) commercial fire tube boiler technology using Dynamic Staged Entrainment (DSE) burner technology, capable of achieving NO_x emissions below 5 ppm without the use of selective catalytic reduction. This demonstration prototype was successfully installed and source tested at Mission Linen in Santa Barbara in the 4th quarter 2016. Boiler performance testing will be conducted throughout 2017

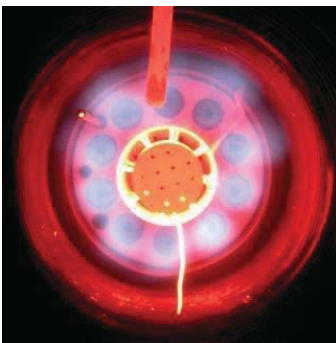



> Indoor Air Quality Study

This study investigates whether the ventilation provisions of California's Title 24 building code are sufficient to maintain acceptable indoor air quality (IAQ), and whether the requirements could be modified to improve energy efficiency while still maintaining IAQ. Approximately 70 homes in northern and southern California will be instrumented to collect air quality data. In 2016, PG&E completed the installation of test instruments in participating homes. GTI/SCG are scheduled to complete installations in homes located in southern California in 2017. A final report is planned for March 2018.



> Class 4 CNG Plug-In Hybrid

Developed and demonstrated a CNG-powered 14,500- pound, Class-4 medium-duty truck with hybrid electric drive. EDI's solution can improve the fuel economy of a conventional CNG-powered medium-duty truck by more than 40 percent. This technology can effectively increase the miles per gasoline gallon equivalent (GGE) of a baseline.



> Near Zero Emission 8.9L Engine Development

Developed the game-changing Cummins Westport ISL G NZ engine for medium truck and bus market segments, such as transit and refuse transfer trucks. exhaust emissions are 90% lower than the current EPA NOx limit of 0.2 g/bhp-hr. California ARB has defined this certified Near Zero emissions level of 0.02 g/bhp-hr NOx as equivalent to a 100% battery truck using electricity from a modern combined cycle natural gas power plant. The ISL G NZ also meets the 2017 EPA greenhouse gas emission requirements with a 9% GHG reduction from the current ISL G.



> Near Zero Emission 12L Engine Development

Initiated the development of the Cummins Westport ISX12 G natural gas engine. The ISX12 G natural gas engine is a larger-displacement natural gas engine suitable for a variety of heavy-duty vehicles, including regional-haul truck/tractor, vocational, and refuse applications. The near zero ISX12 G exhaust emissions are 90% lower than the current EPA NOx limit of 0.2 g/bhp-hr. California ARB has defined this certified Near Zero emissions level of 0.02 g/bhp-hr NOx as equivalent to a 100% battery truck using electricity from a modern combined cycle natural gas power plant. With a displacement of 11.9 liters and up to 400 hp and 1450 lb-ft. of torque, the ISX12 G is the natural choice when considering alternative fuel for demanding applications.

Gas Operations

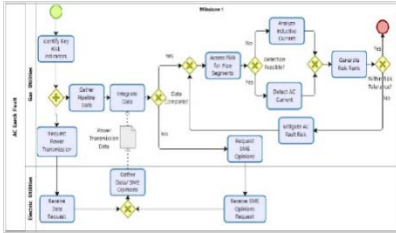

> AC Earth Faults

Earth/ground faults from high power AC sources can damage pipelines and coatings. Project started in late 2016. A predictive model is being developed to show what areas are at risk for the greatest exposure to AC faults. Project deliverable may comprise of a mitigation plan that establishes proper spacing between facilities in a utility right of way.



> Pipeline Corrosion Control

A new cathodic protection system may reduce the cost of protecting our steel pipelines in remote locations where utility power is not available. A Solid Oxide Fuel Cell Rectifier was installed in late 2016 at a remote desert location where its performance is being evaluated over a one-year (4-season) period. If proven to be reliable and efficient, it will replace the lower capacity, higher cost Thermo-Electric Generators currently in use.

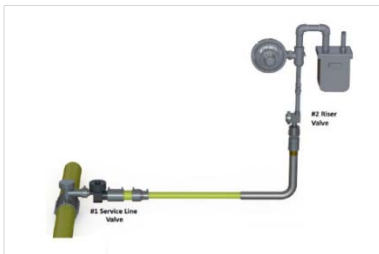

> Intelligent Shutoff Device

Gas pipelines are particularly vulnerable to damage from third party excavators. An intelligent shutoff system has been designed to shutoff gas flow if the system detects the smallest leak from the outer protective casing. A prototype system has been fabricated and successfully tested. The final phase in 2017 will produce 20 systems for an in-ground 6-month pilot field test.



> Leaks from Slow Crack Growth in PE

Assess how a leak evolves overtime in plastic pipe due to slow crack growth (SCG) to gain a better understanding of how this contributes to methane emissions from distribution pipelines. Significant progress was made on the design and construction of Leak Evolution test rig and hardware upgrading of the Cyclic Pressure tester. Completion of the CP tester in early 2017 will allow the creation of SCG in plastic pipe samples.

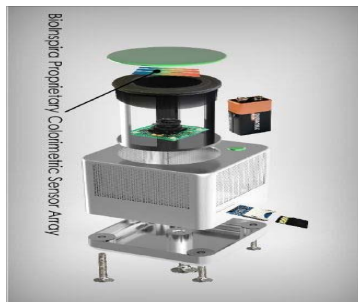

> State of the Art Methane Sensors

Detection and quantification of methane emissions is important for the entire natural gas industry since methane is a GHG. This project is to investigate the current state of the art in methane "point" sensors and how they are used in the utility industry. A technical assessment of twenty-eight (28) methane detection technologies were performed. A unique sensor chip from Biolnspera uses colorimetric analysis to measure specific gases has been selected to be tested in 2017.



> Emissions Quantification Validation Protocol

Methane emissions quantification technologies were evaluated in a series of controlled and real world tests. There is a need for a Validation procedure to ensure traceability and reproducibility of measurement data. API 1163 “In-line Inspection Systems Qualification Standard” has been selected as the model to follow in the development of a formalized Validation procedure. Additional field tests will be performed in 2017 to substantiate the Validation protocol.



> Hydrogen Natural Gas Blend Operational Impacts

USC's Engineering School completed laboratory tests of hydrogen blended gas supplies simulating storage operations. High pressure permeability tests were performed on the impermeable upper layers of rock (caprock) and cement samples. Although hydrogen molecules are small, the study showed that hydrogen molecules did not permeate through the caprock. It is recommended further research is needed to enhance the confidence of USC's initial findings.



> PE Pipe Technology

Quality control inspections of plastic material is critical to ensure material quality and reliable long-term performance. Manual wall thickness measurements of plastic pipe are limited to the pipe ends. However, a UT gauge can measure along the entire length of a pipe segment. A comparative assessment of a digital UT gauge and the standard micrometer was performed. Results showed the UT gauge can serve as an alternative method to the micrometer for making accurate wall thickness measurements. With proper calibration, the UT gauge readings were within 0.002” of the micrometer measurements.

Low Carbon Resources

> Biogas Processing and Upgrading Technology Assessment and R&D Pathways



Completed study to characterize and evaluate biogas conditioning and upgrading technologies that would allow the injection of upgraded biogas into existing natural gas pipelines that meet the requirements of SCG Rule 30 and AB 1900. Key conclusions were: processes are well established to perform removal of water, hydrogen sulfide (H_2S), siloxanes, nitrogen (N_2), oxygen (O_2), and carbon dioxide (CO_2) from various biogas sources in order to meet gas specifications for pipeline injection.

> Demonstration of Digester Gas Fired Engine



The objective of this demonstration was to identify a reliable, cost effective method to achieve SCAQMD Rule 1110.2 compliance using digester gas (DG) fuel for engines. In 2015, Tecogen emission control technology was successfully installed on a rich burn engine that runs on digester gas at the Eastern Municipal Water District water treatment facility in Perris, California. The engine and emission control system successfully ran throughout 2016. This project has been completed.

> Solar Thermal Heat Pump - Chromasun

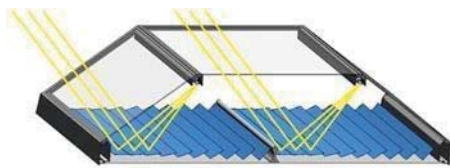

Chromasun completed an evaluation of baseline energy use at the JW Marriot Hotel in Palm Desert in 2014/2015 in preparation to install and monitor this solar thermal demonstration project. Also, final system designs to install the solar system at this hotel were completed in 2015 along with permitting activities with the city of Palm Desert. System installation will be completed in 2016.

> Hybrid Solar System

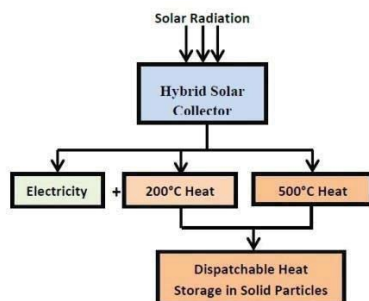

Developed a Hybrid Solar System (HSS) that integrates a Hybrid Solar Collector using Non-Imaging Optics (NIOs) and Photovoltaic (PV) components with a Heat Transfer and Storage System using particle laden gas as thermal media to simultaneously generate electricity and high temperature heat. This project was completed in late 2015 and demonstrated a tunable receiver with up to $365^{\circ}C$ receiver outlet and about 40% thermal efficiency. Also, no particle degradation was observed with the energy storage media.



> **Thermal Energy Storage with Supercritical Fluids**

Developing a novel and low-cost approach for implementing a thermal energy storage system designed to operate over a wide range of thermal energy storage. The approach employs a patent-pending concept that uses elemental fluids for the storage material.



> **Renewable Hydrogen and Methane from Solar Thermocatalytic Water Splitting**

In collaboration with DOE, University of California, San Diego (UCSD) and Science Applications International Corporation (SAIC), SCG supported the development of a high-temperature sulfur-ammonia solar thermochemical water-splitting cycle to produce renewable hydrogen and methane. Improvements were made to electro-catalysts and a 500-hour durability test was initiated to demonstrate the long-term stability of the electrolytic cell materials. The development team is now preparing for on-sun testing at a concentrating solar dish recently installed at San Diego State Brawley.



> **Biomethane Purification Demonstration**

Demonstrated an advanced state-of-the-art biogas system that was upgraded to pipeline-quality standards. SCG designed and installed a heavily instrumented biogas processing system comprised of pressure swing adsorption (PSA) vessels, activated carbon media and a hydrogen sulfide reactor at a waste water treatment plant in Escondido, CA. Over the 18-month demonstration period, the upgrading system reliably converted highly contaminated, CO₂ rich biogas from the facility's anaerobic digesters into pipeline-quality renewable natural gas.



> **Solar Baseload Power Generation using Natural Gas Pipeline**

Development of a power-to-gas energy storage dynamic simulation model incorporating performance parameters for multiple elements (e.g., start-up time, shut down time, transients from solar).

Concurrently, the NREL team will design, build and operate a small- scale physical power-to-gas system to test the system performance.

3. Financial Summary

SCG's RD&D budget is currently divided into four program areas:

1. Customer Solutions: Energy Efficiency in the residential, commercial, and industrial markets, Clean Generation & Transportation
2. Gas Operations: Environmental & Safety, Operations Technologies, System Design & Materials, and System Inspection & Monitoring
3. Low Carbon Resources
4. Program wide Partnership

Please see the Program Area Overview for details of RD&D in these four areas.

2016 Expenditures

Table 2 shows the distribution of 2016 expenses

Program	Sub-Programs	2016 Expenditures
Customer Applications	Clean Generation	\$410,640
	Clean Transportation	\$1,549,509
	Customer End Use Applications	\$1,639,266
	Total	\$3,599,415
Gas Operations	Environmental & Safety	\$582,027
	Operations Technologies	\$150,929
	System Design & Materials	\$275,555
	System Inspection & Monitoring	\$553,536
	Total	\$1,562,046
Low Carbon Resources	Carbon Capture, Utilization and Sequestration	\$137,235
	Renewable Natural Gas & Renewable Hydrogen	\$2,278,986
	Solar Thermal and Thermal Energy Exchange	\$375,718
	Total	\$2,791,939
Program Wide Partnership	Program Wide Partnership	\$2,691,369
Total		\$10,644,770

Program Leverage

To increase RD&D program effectiveness, enhance probability of program success, avoid duplication and amplify benefits to ratepayers, SCG's RD&D expenditures are highly leveraged through collaboration with other funding sources such as CEC, CARB, DOE, and local air quality districts. Table 2, shown below, displays SCG commitment as well as Co-Funding amount of the projects within this report. The recent co-funding ratios for each RD&D program area based on active projects in 2016 are shown in Table 2 below. This co-funding ratio indicates that, on average, for every dollar of SCG RD&D program funding expended, roughly four and a half additional dollars are used to fund projects of interest and benefit to ratepayers.

Table 3: Program Co-Funding Ratio Based on 2016 Active Projects

	SCG Commitment	Co-Funding Amount	Total Project Amount	Co-Funding Ratio
Customer Applications	\$ 5,869,195.00	\$ 32,717,156.00	\$ 38,586,351.00	6.57
Gas Operations	\$ 2,237,050.00	\$ 9,018,181.00	\$ 11,255,231.00	5.03
Low Carbon Resources	\$ 5,961,025.00	\$ 3,997,474.00	\$ 9,958,499.00	1.67
Program Wide Partnership	\$ 1,275,350.00	\$ 6,355,700.00	\$ 7,631,050.00	5.98
Total	\$ 15,342,620.00	\$ 52,088,511.00	\$ 67,431,131.00	4.40

Collaboration partners provide robust stakeholder engagement and technology gap assessment processes to ensure their research programs address specific technology needs that are not being met through other means and have a high potential for commercial success. These processes augment SCG's own industry, agency, and university engagement processes to identify unmet or partially unmet technology development needs. As a collaborator with other funding entities, SCG plays a unique role in creating SCG customer benefits and advancing state and Commission policy goals.

4. Royalties and Equity Investments

To maximize the value to ratepayers of RD&D expenses, the CPUC approved RD&D program allows for negotiation of royalty and equity arrangements with companies participating in the program. When possible, SoCalGas negotiates product royalty rights or equity interest in companies developing targeted technologies in exchange for RD&D funding that is used to support technology development and demonstration. These arrangements provide an opportunity for SoCalGas ratepayers to receive a direct financial return should the technology development efforts prove successful.

In 2016, SoCalGas did not enter any new equity arrangements, however in 2015 a bridge loan was made to existing portfolio company Clean Energy Systems. The loan was repaid in full with interest, in 2015 and involved an enhancement to SoCalGas' existing warrant rights. In addition, technology sourcing activities were undertaken through program participation with the LA Cleantech Incubator and the Enertech Capital industry partners program. Furthermore, SoCalGas received roughly \$106,000 in continued royalty payments directly benefitting ratepayers.

5. Customer Applications

The Customer Applications RD&D program consists of three sub-program areas: Customer End Use Applications, Clean Generation & Clean Transportation.

A) Customer End Use Applications

The objectives of Customer Applications RD&D are to develop and commercialize technologies that cost-effectively improve the efficiency and reduce the environmental impacts of natural gas end-use equipment. SoCalGas pursued projects in areas that are focused on the development and demonstration of next-generation condensing water and space-heating appliances, gas heat pumps, solar thermal systems for water heating, space conditioning, clothes drying, commercial cooking and industrial boilers and process heaters. Underlying technology elements of focus will include improved burner and combustion systems for NOx control, thermal management, improved materials, control systems, and reduce equipment first cost.

Drivers

SCG's primary focus of the Customer End-Use Applications program is to support the advancement and deployment of technologies related to the use of natural gas in residential, commercial and industrial appliances and equipment. Key objectives are to meet and exceed environmental and air quality requirements as mandated by local state and federal regulations and to develop cost effective, high efficiency gas-fired equipment to reduce energy costs and greenhouse gas emissions. The primary drivers that affect this program area are efficiency improvements, emission reduction mandates and cost reduction of equipment

Sub-Program Descriptions

SCG's **Customer End Use Application program** is divided into five Project Areas under the **Customer End Use Applications sub-program**: 1) Zero Net Energy for Residential, 2) Appliances & Indoor Air Quality, 3) Commercial Cooking and Food Services, 4) Solar Thermal Heating & Cooling, 5) Boilers & Process Heating.

- 1) **Zero Net Energy for Residential:** This Project Area focuses on developing and demonstrating Zero Net Energy (ZNE) homes and development of new high efficiency residential appliance technologies. Development and integration of new high efficiency appliances combined with renewable products like solar thermal, photovoltaic and fuel cells need to be successfully demonstrated. Costs for many of these products need to be reduced significantly to make these systems affordable for the homeowner. The technologies are varied, including gas-fueled ovens and ranges,

MicroCHP, furnaces, clothes dryers, water heaters and home refueling appliances for CNG passenger cars.

SoCalGas will also focus on development and demonstration of MicroCHP products for the ZNE home of the future. There are many new MicroCHP products (fuel cells, engine based CHP and small turbines) that are entering European and Asian markets that offer a reasonable payback to the consumer when incentives and high energy costs are factored in. However, these products are expensive in the United States due to relatively cheap electric and natural gas energy costs. Substantial reductions in capital costs are needed to offer consumers a financially attractive option for our market conditions. Other advanced gas products, like gas heat pumps, also require significant reduction in first costs to be competitive in the United States.

- 2) Appliances & Indoor Air Quality:** This project area focuses on developing and demonstrating new residential appliance technologies and complying with environmental regulations. Development and integration of new high efficiency appliances combined with renewable products like solar thermal and photovoltaic systems need to be successfully demonstrated. Costs for many of these products need to be reduced significantly to make these systems affordable for the homeowner.

In addition, SCG will look at indoor air quality issues. The focus of this project area is to collect and analyze IAQ-related field data from new gas homes reflecting different construction types, locations and seasons. Results from IAQ studies will be needed for proper design in future ZNE buildings.

The SCAQMD is proposing new emission regulations on residential and commercial gas-fired equipment as discussed in the 2016 Air Quality Management Plan under Control Measure CMB-02. This measure seeks NOx emissions reductions from unregulated commercial space heating furnaces and further reductions from replacement of older boilers, water heaters, and pool heaters with new high efficiency, low NOx emission products. This measure includes a mix of regulatory and incentive-based methods of control.

- 3) Commercial Cooking and Food Services:** RD&D activities focus on improving commercial cooking equipment used in institutional and commercial food service. There are more than 25,000 restaurants in the SCG service territory that use natural gas-fueled cooking equipment (ovens,

steamers, fryers, charbroilers, griddles, ranges) in their daily operation.

In March 2017, the SCAQMD approved new emission control measures on commercial food service equipment (2016 Air Quality Management Plan under Control Measure CMB-04). This control measure will seek NO_x reductions from commercial cooking equipment by incentivizing the use of low NO_x equipment. In addition, the SCAQMD will consider developing a manufacturer based rule to establish emission limits for these cooking appliances. Also, PM emissions from under-fired charbroilers will be regulated (control measure BCM-01).

SCG has been a leader in the development and promotion of high-efficiency products rated by the United States Environmental Protection Agency (EPA) ENERGY STAR program. SCG will continue to fund development work of high efficiency cooking equipment through GTI and the UTD consortium.

- 4) Solar Thermal Heating & Cooling:** Solar technologies can be used as a substitute for natural gas for many applications such as domestic hot water, space heating and cooling and industrial process heating to reduce GHG emissions and lower operating costs. However, the greatest challenges for solar thermal are the high capital cost and relatively low (<60%) system efficiency.

As noted in the section above, the SCAQMD is proposing new emission regulations on residential and commercial gas-fired space heating equipment as discussed in the 2016 Air Quality Management Plan under Control Measure CMB-02 by adopting an NO_x emission limit on commercial space heating units. (Proposed NO_x emission levels of 14 ng/joules that match regulations on residential space heating equipment are likely).

- 5) Boilers & Process Heaters:** SCG RDD will continue to focus on development of near zero emission burner systems for application in boilers and various process heaters. This work will be necessary to address regulations passed by SCAQMD in their 2016 AQMP under control measures CMB -01. Specific emission limits for each equipment type (i.e. boilers, metal melting furnaces, industrial dryers) will likely be identified in future regulatory proceedings in 2018 and 2019. SCAQMD proposes to rely upon a combination of regulatory and incentive based strategies to transition non-power plant combustion sources to zero or near-zero emission technologies as those technologies become technologically feasible and

cost-effective. Incentive measures could be implemented to allow early retirement and advanced replacement of equipment with zero and near-zero emission technologies.

B) Clean Generation

SoCalGas' Clean Generation RD&D program focuses on supporting the development and demonstration of high-efficiency, low-emissions CHP systems for the residential, commercial, and industrial market segments within the SoCalGas service territory. This program support development and market introduction of low-emission, distributed generation technologies working with equipment providers developing emissions control technologies, improving total system efficiency and lowering the cost of CHP and other natural gas distributed generation solutions that meet the unique environmental requirements of southern California. Clean Generation RD&D activities include: small-scale CHP systems featuring advanced emission control systems capable of meeting current and future AQMD NOx limits; fuel cell systems demonstrating improved efficiency, performance and reliability; and smaller residential scale systems. Systems for recovering waste heat and those using alternative thermal cycles, such as Stirling cycle, free-piston engine, and rotary engines, with the potential for improved efficiency and low cost will be pursued.

Drivers

SCG's primary focus of the Clean Generation program is to support the advancement and deployment of technologies related to the use of natural gas in distributed generation and combined heat & power applications. These primary objectives are to meet and exceed environmental and air quality requirements as mandated by state and federal regulations, the Federal Clean Air Act and the state legislative decisions of AB 32, for the reduction of NOx and GHG to levels that are the most stringent in the nation for the power generation sector. The primary drivers that affect this program area are efficiency improvements, and emissions and cost reduction.

Sub-Program Descriptions

SCG's Customer Solutions program is divided into four Project Areas under the Clean Generation sub-program: 1) Fuel Cells, 2) Engines and Turbines, 3) MicroCHP, and 4) Waste Heat Recovery.

- 1) **Fuel Cells:** Over the past 25 years, a great deal of R&D has gone into fuel cells. However, there is still significant work to be done to make these appliances competitive in the marketplace. All fuel cells work essentially the same way --- an electrochemical reaction between hydrogen and oxygen in the presence of a catalyst. The catalyst splits the hydrogen atom and the

resulting electron flow provides electricity; with the by-products of this reaction being heat and water. As can be imagined, this is a perfect micro-CHP scenario — heat, electricity and water out, with low emissions and no moving parts. The hydrogen is usually “generated” by a reformer (fuel processor) from a hydrogen-rich fuel — typically natural gas.

SCG has supported the development and demonstration of numerous products including UTC phosphoric acid units (12.5, 40, and 200-kW), MC Power molten carbonate units, Plug Power 5-kW PEM fuel cells, two FCE molten carbonate systems, and a 1.5-kW Ceramic Fuel Cells Ltd. (CFCL) solid oxide fuel cell. SCG has provided financial and technical support to several organizations including the National Fuel Cell Research Center, the California Stationary Fuel Cell Collaborative, the California Hydrogen Business Council, and the California Fuel Cell Partnership. SCG’s Clean Generation program will continue to assess ways to accelerate the commercialization process with various fuel cell manufacturers. SCG will support work on both high and low temperature fuel cells in residential, commercial, and industrial applications. SCG is currently demonstrating a 1.5 kW fuel cell at UC Irvine in a residential mixed fuel Zero Net Energy simulator.

- 2) Engines and Turbines:** CHP is the most energy-efficient and cost-effective form of distributed generation. The use of CHP systems in commercial, industrial, and multifamily residential establishments will improve the overall efficiency of energy use by displacing fuel use in boilers and marginal sources of electricity consisting of aging gas-fired central generators.

The primary objective in the Engine and Turbine project area is to demonstrate and test two technologies – turbines and internal-combustion engines. Advanced combustion technologies and catalyst systems will be developed and incorporated to make the overall DG/CHP systems environmentally friendly in meeting local air agency permitting requirements that are the most stringent in the world. In addition, system integration, along with advances in power conditioning electronics, will reduce costs and simplify the installation process. Another objective is to test advanced emission monitoring systems which can provide alarms and trending information to operators to ensure that emissions are maintained at or below permitted limits. To address requirements for renewable energy, a focus of research and demonstration is the application of renewable gasses towards power generation in engines and turbines. Finally, the RD&D program seeks to lower manufacturing costs and increase the efficiency and reliability of

internal-combustion engines for all related applications including power generation, cogeneration, space conditioning, refrigeration, air compression, and water pumping.

- 3) Micro-CHP:** Micro-CHP generates two forms of energy (heat and electricity) on a scale that can provide a residence or a small commercial building with enough power as well as heat to meet a significant portion of building energy needs. The total system efficiencies are typically greater than 85 and may provide an excellent equipment strategy for home builders in meeting future Zero Net Energy mandates. Currently, there are five technologies that are used to supply power today for micro-CHP systems and include: Stirling engines, Fuel cells, Microturbines, Internal combustion engines, and Organic Rankine cycle. All micro-CHP products are required to meet CARB Certification emission regulations for installation throughout California. These emission regulations are the most stringent in the world and pose a big development / technology challenge for successful commercialization for OEMs. SoCalGas RDD activities are typically focused on demonstration of various new micro-CHP products to validate system efficiency and emission levels relative to CARB DG certification.
- 4) Waste Heat Recovery:** SoCalGas is a decoupled utility with a focus on reducing gas use through promotion of energy efficiency programs for residential, commercial and industrial customers. Incentive programs for waste heat recovery technologies are a key part of these energy efficiency programs. SoCalGas RDD participates in the development and demonstration of new cost effective heat recovery technologies including new heat exchanger designs and new innovative ways to utilize waste heat from a variety of residential, commercial and industrial processes / equipment. Ongoing projects include demonstration of organic Rankine cycle (ORC) products, recovery of turbine waste heat to power a waste heat boiler, recovery of turbine waste heat to power an absorption chiller and recovery of waste heat to provide humidified air for residential homes. ORC systems have been slow to enter the markets in the United States due to relatively inexpensive energy costs. The process is such that low temperature waste heat off an industrial process heats an organic fluid of high molecular mass and low boiling point that produces a vapor which is used to rotate a scroll expander and the shaft is connected to a generator to produce power. Improved economics are needed to successfully commercialize ORC systems (and other low temperature waste heat recovery systems) in the United States.

C) Clean Transportation

SoCalGas' Clean Transportation RD&D activities focus on minimizing the environmental impacts related to the use of natural gas as a transportation fuel and on reducing the cost of natural gas transportation. California's transportation sector, having one of the nation's largest transportation infrastructures to support its demand, is subjected to the most stringent emissions standards in the nation. As set forth by the EPA, CARB, and SCAQMD, emissions standards are being reduced to the lowest levels the industry has seen and across the nation. Companies and entities operating on/off-road vehicles within the boundaries of both the South Coast Air Quality Management District (SCAQMD) and the San Joaquin Valley Air Pollution Control District (SJVAPCD) must adhere to the new emissions regulations to improve air quality to protect and propagate a cleaner environment for public health, by a certain time frame/period. Specific areas of SoCalGas development and demonstration support include engine control and after-treatment systems to reduce emissions, engine and drive-line efficiency improvements (such as air-fuel systems and hybrid drive), cost reduction for fueling infrastructure and on-board natural gas storage tanks, and synergies between natural gas and hydrogen transportation and infrastructure technologies.

Drivers

SCG's primary focus of the Clean Transportation program is to support the advancement and deployment of technologies related to the use of natural gas as a transportation fuel. These primary objectives are to meet and exceed environmental and air quality requirements as mandated by state and federal regulations, the Federal Clean Air Act and the state legislative decisions of AB 32, for the reduction of NOx and GHG to levels that are the most stringent in the nation for the transportation sector.

Areas of activity including fueling systems, natural gas on-board storage and near-zero emission engine development. The primary drivers that affect this program area are efficiency improvement, and emissions and cost reduction.

SCG's **Clean Transportation program** focus is divided into five primary sub-programs:

- 1) Near Zero Emission Engines, 2) CNG & Hybrid Vehicles, 3) Marine & Rail,
- 4) Compression & Home Refueling, and 5) Fuel System & Storage.

Sub-Program Descriptions

- 1) **Near Zero Emission Engines:** California's emissions standards are the most stringent in the nation, if not the world. The objective of this research is to develop and demonstrate that Compressed Natural Gas engines can achieve near zero emission standards, with respect to NOx, and are

cleaner burning than petroleum liquid fuels. Other areas of research include improved fuel efficiency of CNG engines and how Near Zero Emission engines can reduce Greenhouse Gases with the addition of Renewable Natural Gas.

- 2) CNG & Hybrid Vehicles:** The objective of this research is to further expand on Near Zero Emission engines. CNG & Hybrid vehicles utilize both clean burning engines and electric motors to help with California's efforts to reduce NOx and GHG emissions. The development and demonstration of these vehicles will help transform the transportation industry to utilize both electric motors and CNG engines to allow vehicles to operate full electric mode producing zero emissions while operating in underprivileged communities without having to compromise range. This new technology has multiple benefits to help improve California's air quality.
- 3) Marine & Rail:** The focus of this objective is to research, develop, and demonstrate CNG technologies in the marine and rail sector. These two sectors have been heavily dominated by diesel and petroleum based fuels for decades and big benefactors into California's NOx and GHG emission levels. Although technology adoption is less prominent, California has put strict emission standards that need to be met. Los Angeles has one of the nation's busiest goods movement industries, is a big contributor to air quality in the region. Key projects are to look at alternative fuels and technologies to be utilized in these areas that can drastically lower NOx and GHG levels, while benefitting surround underprivileged communities. This in turn will improve air quality and health of the population around these busy terminals.
- 4) Compression & Home Refueling:** A key component for market transformation and adoption of natural vehicles is a need for efficient and cost efficient storage systems and infrastructure options. Projects range from more compact commercial-scale CNG station technologies to demonstrating NGV home refueling systems. Prime criteria that are assessed are lower operational and upfront costs, easy installation and maintenance, as well as innovative compression technologies.

5) Fuel System & Storage: The objective of this research is to develop and demonstrate safe, reliable, and cost-effective CNG fuel and storage systems for all types of mobile natural gas applications. These projects are key areas improvements to the infrastructure for vehicular applications to provide owners and operators of NGV's a viable and cost-effective fueling and re-fueling options. As the focus of the transportation sector evolves and focuses towards cleaner technologies, another objective SCG supports is the development of advanced on-board CNG storage cylinders. These storage cylinders help increase capacity, reduce weight, and/or reduce bulk volume compared with current cylinders, which will make natural gas a feasible alternative to other fuels.

6. Gas Operations

The Gas Operations RD&D program consists of four sub-program areas: Environmental and Safety, Operations Technologies, System Design and Materials, and System Inspection and Monitoring.

Gas Operations

SoCalGas' Gas Operations RD&D activities focus on the development of new technologies that help SCG enhance pipeline (public) and employee safety, improve operating efficiency and reliability, meet regulatory mandates, reduce GHG emissions, and ensure gas quality of renewable resources is compatible with the infrastructure. The suite of projects under development are performed primarily through In-House research, Universities, and collaborative research organizations such as Sustaining Membership Program, Operations Technology Development, NGA/NYSEARCH and Pipeline Research Council International.

Drivers

The Gas Operations program follows the CPUC guidelines established under Decisions D.82-12-005 and D.90-09-045. Primary drivers of the Gas Operations program are to meet the requirements of Federal Code 49 CFR 192, CPUC General Order 112-F and Decision D.14-01-034 (Biomethane Quality), AB 32 (GHG Reduction) and SB 1371 (Natural Gas Leakage Abatement). The main objective in this program is to support the development, demonstration and deployment of technologies that enhance the safety and integrity of the natural gas system in the areas of design, inspection, monitoring, quality control and construction. Advanced technologies for methane emissions detection, quantification and mitigation are also pursued in this program. Examples include ground and aerial leak detection systems, pipeline material tracking and traceability, pipeline and ground movement detection sensors and internal robotic inspection technologies.

Sub-Program Descriptions

Environmental & Safety

The Environmental & Safety sub-program is comprised of five Project Areas: 1) Damage Prevention, 2) Emissions Detection, 3) Emissions Quantification, 4) Environmental, and 5) Safety.

This subprogram looks to improve customer, public, and worker safety and to reduce greenhouse gas (GHG) emissions. Specific objectives include the development of advanced systems to identify and mitigate threats to the pipeline system, detection and quantification of gas leaks, safety shutoff devices for aboveground facilities, ergonomic

tools and personal protection equipment for worker comfort and safety.

Operations Technologies

The Operations Technologies sub-program is divided into two Project Areas: 1) O&M Technologies and 2) Strategic Technologies.

This sub-program aims to develop and deploy new technologies that improve the efficiency of inspecting, operating, maintaining, and rehabilitating gas pipeline systems and to ensure that these systems continue to provide safe and reliable service. New technologies include innovative field tools and equipment, innovative pipeline replacement processes, and utility excavation and restoration methods.

System Design & Materials

The System Design & Materials sub-program consists of five Project Areas: 1) Materials and Equipment, 2) Engineering & Design, 3) Storage Field Downhole Technologies, 4) Compressor Technologies and 5) Gas Composition and Quality.

The objectives of this sub-program are to advance the reliability, asset life, and efficiency of equipment and systems used in high-pressure gas utility operations. Projects include developing tools to comply with pipeline integrity and inspection regulations, advancing and implementing new engineering design standards, improving the operational efficiencies of gas storage and compressor station assets, and assessing the effects of gas quality from non-traditional sources (biogas and hydrogen-blend) on the gas delivery systems.

System Inspection & Monitoring

The System Inspection & Monitoring sub-program has a Project Area that covers Pipeline Inspection Technologies.

The objectives for this Sub-program include developing technologies and methods for internal inspection of pipelines, direct and indirect performance monitoring of facilities. For example, the demonstration of small unmanned aerial systems (drones) for potential utility applications, such as visual inspection of inaccessible pipelines and above ground assets, has been initiated. Also, further development of advanced sensors to expand the capabilities of internal robotic inspection systems are underway.

7. Low Carbon Resources

SoCalGas' Low Carbon Resources RD&D activities focuses on the development and commercialization of technologies that cost-effectively decarbonize the natural gas supply chain through the development of renewable natural gas resources, energy conversion technologies and carbon capture, use and sequestration technologies. SoCalGas' Low Carbon Resources RD&D activities seek to support the development and deployment of technologies across the natural gas supply chain that cost effectively enhance energy reliability and sustainability, improve local air quality, and reduce greenhouse gas (GHG) emissions.

Drivers

SCG's primary focus of the Low Carbon Resources program is to support the advancement and deployment of technologies that reduce carbon emissions across the natural gas supply chain. These technologies will help Californians meet and exceed environmental and air quality standards mandated by state and federal regulations, such as AB32 and the Federal Clean Air Act. Meeting these standards requires substantial increases in the production of both renewable natural gas (RNG) and renewable hydrogen (RH₂) and the development of carbon capture, utilization and sequestration technologies.

Sub-Program Descriptions

SCG's **Low Carbon Resources program** is divided into five Project Areas: 1) Biomass Gasification, 2) Power-to-Gas, 3) Artificial Photosynthesis, 4) Carbon Capture and Utilization, and 5) Low Carbon Hydrogen from Methane.

- 1) Biomass Gasification:** This Project Area focuses on developing and demonstrating commercial scale biomass gasification technologies capable of converting biomass resources, including purpose grown crops, forest thinnings, agricultural residues, and waste water treatment by-products, into low, zero, or negative net carbon RNG. Many of these technologies have been demonstrated to be technically feasible at the lab or pilot scale. However, in order to have a significant impact on California's 2 Tcf/y natural gas supply, these systems must become financially sustainable. Research will focus identifying optimal sites for commercial scale projects, demonstrating system performance, and developing economic models for large scale deployment of gasification systems.

- 2) Power-to-Gas (P2G):** This project area focuses on developing and demonstrating technologies that can convert excess or dedicated wind and solar power into renewable hydrogen or renewable natural gas. As additional renewable power resources are deployed in California, diurnal and seasonal mismatches between supply and demand on the electric grid will increase. P2G converts excess wind and solar power that would otherwise be lost into RH₂ and RNG. This allows that energy to be injected into the natural gas pipeline system where it can be stored for later use or distributed as a vehicle fuel. Blending renewable gases onto the natural gas pipeline system can also reduce congestion on the electric grid by moving renewable energy from areas of high production to areas of high demand. P2G technologies serve as dispatchable loads and supplies that provide ancillary services to the electric grid, improving electric grid stability and reliability.
- 3) Artificial Photosynthesis:** This project area focuses on supporting fundamental laboratory research to identify and optimize catalysts that will produce RNG directly from water, CO₂, and sunlight. While this technology is in the early stages of development, advances have already been made identifying catalysts that produce hydrogen directly from water and sunlight. This technology holds the promise of allowing the production large quantities of zero carbon natural gas that can be easily transported on the existing natural gas grid to be stored, converted to electrical power, combusted for home or industrial process heat, or used as a vehicle fuel.
- 4) Carbon Capture and Utilization:** This project area focuses on developing and demonstrating technologies that can capture CO₂ and convert it into durable materials that provide value and sequester the carbon for long time periods. Carbon capture technologies that focus either on addressing concentrated CO₂ streams, such as flue gas, can help our customers meet their GHG emission goals and those goals set by the state and federal rules and regulations. Technologies that focus on more dilute CO₂ sources, such as ambient air, can be conveniently located close to CO₂ demands. For example, both P2G and artificial photosynthesis will require distributed CO₂ supplies for widespread deployment.
- 5) Low Carbon Hydrogen from Methane:** This program area focuses on developing and demonstrating small scale, distributed systems that convert methane to hydrogen via pathways that reduce the carbon intensity of the hydrogen as compared to traditional steam methane reforming. These technologies may use renewable electricity or heat to help drive the

reaction or incorporate carbon capture in the conversion process.

Using hydrogen as a vehicle fuel can significantly reduce local pollutant emissions and smog precursors. However, transporting hydrogen by truck to fueling station is expensive and results in additional GHG and pollution emissions. Small scale, distributed hydrogen production systems can utilize the nearly ubiquitous natural gas system to supply low carbon fuel to fuel cell electric vehicle service stations that are now being built across the state.

8. Program Wide Partnership

SoCalGas' Program Wide Partnership RD&D activities focuses on collaboration with many governmental and private organizations to fund research development and demonstration projects of mutual interest. These collaborative RDD efforts provide significant financial benefits through cost sharing while also increasing the probability of technical and commercial success by tapping into the collective wisdom and experience of all participating organizations. Key organizations are: Department of Energy, California Energy Commission, Utilization Technology Development, Sustaining Membership Program, Operations Technology Development, Pipeline research Council International, NGA/NYSEARCH, National Labs and Universities, and University Outreach

U. S. Department of Energy (DOE): SoCalGas maintains a close collaboration with certain departments within the DOE. These departments include the Office of Energy Efficiency and Renewable Energy (EERE) and the Department of Fossil Energy (FE). Within EERE, SoCalGas participates in projects with several offices: Fuel Cell and Hydrogen Technologies Office (FCTO), Bioenergy Technology Office (BETO), Vehicle Technologies Office (VTO), Solar Energy Technologies Office (SETO), Building Technologies Office (BTO), and Advanced Research Projects Agency-Energy (ARPA-E)

California Energy Commission: SoCalGas works closely with the California Energy Commission (CEC) and has co-funded many projects. The California Energy Commission's Public Interest Energy Research (PIER) Program funds research, development, and demonstration (RD&D) projects to develop, and help bring to market, energy technologies that provide increased environmental benefits, greater system reliability, and lower system costs. Research priorities are guided by California's loading order of preferred energy resources, which prioritizes Energy Commission research investment, first in energy efficiency and demand response; second, in renewable energy and distributed generation; and finally, in clean fossil fuel sources and infrastructure improvements.

Utilization Technology Development (UTD): This 17-member consortium is represented by gas utilities located throughout the United States and Canada, representing 22 million natural gas customers in North America. The overall goal of this organization is to introduce new technologies that help gas consumers save money, reduce emissions, improve efficiencies and optimize the use of natural gas. Annually, UTD manages a multimillion dollar program that spans all end use market sectors. In addition, UTD funding is leveraged with government and private industry funding to

develop and commercialize these new technologies.

Sustaining Membership Program (SMP): This program is a collaborative research and development program managed and performed by the Gas Technology Institute. The program strives to develop new and innovative technology concepts that will build and protect natural gas markets and will reduce the cost of transmission, distribution, and environmental operations for member companies. Both end use and gas operations type projects are selected for funding under the SMP program. GTI currently collects about \$1.5 million per year from the SMP member organizations.

Operations Technology Development (OTD): In a collaborative effort to develop advanced technologies for the natural gas industry, U.S. utilities are combining interests, expertise, and resources into focused R&D projects through Operations Technology Development. OTD is a not-for-profit corporation led by 24 members who serve over 45 million natural gas consumers in the United States and Canada, representing 57% of the households currently served by natural gas.

Pipeline Research Council International (PRCI): PRCI is a community of the world's leading pipeline companies, and the vendors, service providers, equipment manufacturers, and other organizations supporting the natural gas industry. In 2016, combined funding sources will invest more than \$12 million in the ongoing energy pipeline research program. These funds are highly leveraged, and contribute to over \$20 million in pipeline research actively managed by PRCI.

NGA/NYSEARCH: NGA/NYSEARCH is a collaborative Research, Development & Demonstration (RD & D) organization dedicated to serving its gas utility member companies. Members of NYSEARCH voluntarily participate in projects and programs to target RD & D areas that directly address their unique challenges and opportunities. NYSEARCH members represent primarily gas distribution companies from around North America. There are also members who are either straight transmissions companies or who operate transmission as well as distribution pipelines. The NYSEARCH portfolio focuses on developing innovative technologies for transmission pipelines owned by Local Distribution Companies (LDCs).

National Laboratories: SoCalGas works closely on cutting edge technologies with several national laboratories. These include: Jet Propulsion Laboratory (JPL), National Renewable Energy Laboratory (NREL), Pacific Northwest National Laboratory (PNNL), Lawrence Livermore National Laboratory (LLNL), and Lawrence Berkeley National Laboratory (LBNL).

University Outreach: SoCalGas is involved with RD&D projects at several universities. These include: UC San Diego, UC Irvine, UC Davis, San Diego State University, CSU Los Angeles, CSU Long Beach, University of Illinois, Urbana, University of Southern California, UCLA, California Polytechnic University – Pomona, and Harvey Mudd College.

(SEE APPENDIX% FOR INDIVIDUAL PROJECT SUMMARIES)

Appendix A – Customer Applications

Clean Generation - Engine & Turbine

Demonstration of Digester Gas Fired Engine

Demonstration of Digester Gas Fired Engine Meeting AQMD Rule 1110.2 using Tecogen Emissions System

Project Description / Objectives

The primary objective of this demonstration project is to identify a reliable, cost effective method to achieve SCAQMD Rule 1110.2 compliance using digester gas (DG) fuel for engines. The demonstration project will require monitoring for a period of up to 18 months. A summary pilot study report will be prepared to include significant pilot trial events, collected data, discussion and conclusion of pilot study report, and a recommendation on how to proceed based on the results of the pilot study.

The Tecogen emission control system is a technology with the potential to meet Rule 1110.2 emission limits. Previously, the District successfully piloted the Tecogen technology on a natural gas (NG) operated IC engine. Staff has developed plans to demonstrate the feasibility of using the same emission control technology to meet the Rule 1110.2 requirements for engines using digester gas.

Drivers / Benefits

South Coast Air Quality Management District (SCAQMD) Rule 1110.2 impacts an operators ability to use digester gas (DG) to operate internal combustion (IC) engines. Effective January 2016, this rule will further restrict emissions of oxides of nitrogen (NOx) and carbon monoxide (CO). The Tecogen emission control system is a technology with the potential to meet Rule 1110.2 emission limits using either natural gas or biogas.

Results / Status

The Tecogen emission control technology was successfully installed on an rich burn engine that runs on digester gas at the Eastern Municipal Water District water treatment facility in Perris , California. This site was selected to perform the proposed demonstration project because it has an existing digester gas conditioning system and an available IC engine required for the project. A 16 month demonstration project was completed with collection of data to analyze how effective the Tecogen technology is in a digester gas application. The Tecogen emission control system met all project goals.



Project Number	SCG1450001
Start Date	2014
End Date	2017
Estimated Total Project Cost (SCG)	\$150,000
Co-funder	EMWD
Co-funding Amount	\$100,000

Clean Generation - Engine & Turbine

Power Oxidation with Turbine

Demonstration of Power Oxidizer technology with gas turbine

Project Description / Objectives

The proposed Ener-Core's proprietary Power Oxidizer technology coupled with a turbine can be used for on-site power generation using natural gas or (if possible) waste gas from the process while achieving high destruction efficiency and lower emissions. The application of the Power Oxidizer system offers a productive alternative to the flaring of low quality waste gases hence reducing greenhouse gas (GHG) emissions. The exhaust heat from the system can be used for steam or other forms of energy for the process thereby increasing the overall process efficiency.

In this project, a full scale acceptance test (FSAT) will be completed as the final step for the commercialization of the KG2-PO product. This test involves testing the complete actual full scale system with the KG2-3G turbine and the full scale (prototype) Power Oxidizer as a final validation of the technology and application.

Drivers / Benefits

Ener-Core's technology enables various industries to achieve all of the following:

- Power generation while strictly meeting emissions requirements
- Utilize their emissions, rather than solely destroy them
- Reduce their energy purchase costs, through generation of on-site power
- Utilize heat energy for various process requirements (steam, drying, chilling, etc.)
- Reduce NOx and GHG emissions
- Improve the overall process efficiency

Results / Status

Ener-Core has initiated the development of the 2MW size Power Oxidizer with Dresser-Rand's KG2-3G/EF turbine since late 2014. The development has progressed over the last 12 months from design, subscale testing to full scale acceptance testing (FSAT). The FSAT is the final step for commercialization before installing the initial system at a customer site. In this phase of the project, funding will be used to complete the FSAT.



Project Number	SCG16100155
Start Date	2016
End Date	2016
Estimated Total Project Cost (SCG)	\$125,000
Co-funder	Ener-core
Co-funding Amount	\$3,400,000

Clean Generation - Fuel Cell

Demonstration and Evaluation of a 1.5 kW Solid Oxide Fuel Cell (SOFC) System for Mixed-Fuel Zero-Net-Energy (ZNE) Homes

demonstrate and evaluate an integrated 1.5kW SOFC system for a mixed-fuel ZNE home. We will pursue t

Project Description / Objectives

Demonstrate and evaluate an integrated 1.5kW SOFC system for a mixed-fuel ZNE home. We will pursue the following objectives to meet the project goal:

Phase 1:

1. Install and demonstrate the performance of the 1.5kW SOFC system in a mixed-fuel ZNE home simulator, and compare the overall energy balance with all-electric ZNE homes,
2. Prepare materials for dissemination and demonstration of the residential SOFC system, the use of SOFC in mixed-fuel ZNE homes, and the comparison with all-electric ZNE homes, for the October home expo at a KB homes "house of the future" model.

Drivers / Benefits

Demonstrate the value and benefits of integrating PV and a highly efficient on-site MicroCHP Fuel Cell in a mixed fuel ZNE Home. This would represent an advanced and innovative new product offering for single family as well as multifamily residential customers and could help keep gas service in zero net energy homes.

Results / Status

Product testing is under way, initial results are good, unit is performing as expected with initial electrical efficiency just over 60%. The fuel cell has been run over 3,000 hours continuously with one maintenance task preformed, change out of a water filter.



Project Number	SCG16100177
Start Date	2016
End Date	2017
Estimated Total Project Cost (SCG)	\$245,011

Clean Transportation - CNG & Hybrid Vehicles

Class 4 CNG Plug-In Hybrid

Design, optimization, and testing of a CNG Plug-in Hybrid Electric Vehicle for Class 4 trucks.

Project Description / Objectives

The project will consist of designing and optimizing a natural gas fueled intelligent plug-in hybrid electric vehicle powertrain and battery pack to provide 40 miles of all-electric range with full integration within a 6.0 liter Class 4 CNG engine truck. The project will also validate, test, and demonstrate the integrated, full-performance prototype CNG/PHEV on the road, both in operations at Greenkraft and to prospective fleet customers.

The project will utilize a 14,500 pound Greenkraft Class-4 medium duty truck as the demonstration vehicle. The electric-hybrid drivetrain will be provided by Efficient Drivetrains Incorporated and utilize their proprietary on-board controller to allow intelligent operational switching between drive modes to maximize electric range efficiency while minimizing fuel consumption and emissions from the combustion engine.

**Drivers / Benefits**

Integrate and optimize an existing Greenkraft CNG-powered engine with the intelligent EDI drive. Meet or exceed CARB MD/HD on-road emission certification requirements for 2017. Test and validate the integrated CNG-PHEV under normal operating conditions. Define the duty cycles under which the proposed CNG/PHEV can be appealing to prospective fleet customers.

Results / Status

The goal of the project will be to compare the performance of the CNG/PHEV truck to a baseline truck in real world operations through rigorous on-road testing. The test will aim to achieve the highest level of confidence possible in the comparison between the baseline CNG/PHEV trucks. Results will be made available to the public through a final report.

The exciting "Voice of the Customer" event for customer outreach was held at the ERC in October of 2015. The focus was to educate local fleets that could potentially adopt the CNG/PHEV truck.

Project Number	SCG1430025
Start Date	2014
End Date	2016
Estimated Total Project Cost (SCG)	\$200,000
Co-funder	Greenkraft
Co-funding Amount	\$101,000
Co-funder	CEC
Co-funding Amount	\$900,000
Co-funder	CS/EDI/CEE
Co-funding Amount	\$347,190

Clean Transportation - CNG & Hybrid Vehicles

Zero Emission Cargo Transportation

Development and demonstration of CNG hybrid electric drayage truck for ZECT program

Project Description / Objectives

The primary objective for this HEV ZECT project is to assess and evaluate the strengths, relative benefits, and improvement targets across different approaches to hybridizing conventional internal combustion and spark ignited heavy duty vehicles for cargo handling operations. Specifically, this project aims to successfully package, deploy, operate, and test the benefits of hybrid CNG-electric trucks with catenary capabilities and plug in diesel-electric hybrid with quick charge capabilities as vehicle technology options. The project would help to accelerate the introduction and penetration of hybrid electric technologies into the cargo transport sector which will substantially reduce petroleum consumption and greenhouse gases. The SCAQMD's purpose for this initiative is to continue the momentum in bringing zero-emission cargo transport technologies closer to commercial reality in order to improve air quality in one of the most heavily impacted areas in the country.

Drivers / Benefits

This project aims to successfully package, deploy, operate, and test the benefits of hybrid CNG-electric trucks with catenary capabilities and plug in diesel-electric hybrid with quick charge capabilities as vehicle technology options. The project would help to accelerate the introduction and penetration of hybrid electric technologies into the cargo transport sector which will substantially reduce petroleum consumption and greenhouse gases.

Results / Status

The CNG hybrid truck project (Project) is to develop a heavy-duty battery electric truck with CNG range extender and catenary capability for demonstration in real world drayage service to test a hybrid system with a well-balanced blend of all electric and CNG-based hybrid operation to support a full range of drayage duty cycles.

The proposed technical concept provides a well-balanced blend of operating modes that allow the vehicle to function in all-electric mode, a catenary electric mode to operate on a catenary system developed by Siemens and in a conventional hybrid mode using CNG.



Project Number	SCG15310122
Start Date	2015
End Date	2016
Estimated Total Project Cost (SCG)	\$250,000
Co-funder	Port TAP
Co-funding Amount	\$283,495
Co-funder	LADWP
Co-funding Amount	\$389,947
Co-funder	DOE
Co-funding Amount	\$2,813,637
Co-funder	SCAQMD
Co-funding Amount	\$1,578,802
Co-funder	GTI
Co-funding Amount	\$311,438

Clean Transportation - Marine & Rail

VeRail - CNG NZE Locomotive

Develop and demonstrate NZE CNG locomotive for POLA/POLB

Project Description / Objectives

As SCAQMD is pushing for GHG reductions and improving air quality, technologies in the rail industry has not strayed away from diesel. Locomotive manufacturers have developed and demonstrated alternative fuel types, but have still heavily relied on diesel as its primary fuel.

In this project, the partners are teaming up to develop and demonstrate a new low-NOx switcher locomotive. Combining near-zero emissions locomotive engines with onboard high-density CNG Fuel storage at a per locomotive cost, the locomotive will operate exclusively on 100% natural gas which produces no diesel particulate matter, near-zero NOx emissions, and under California LCFS reduce greenhouse gas emissions by 22.7% and over 80% when using Renewable Natural Gas. Running in straight natural gas mode (with no diesel), the VeRail locomotive outlined in VeRail's proposal to SoCalGas will produce no more than 0.02 g/bhp-hr of NOx and no diesel PM. The VeRail locomotives running in straight natural gas mode will thereby meet CARB's goal for a near-zero emissions locomotive. This would equate to a 98.5% reduction in NOx beyond the current the EPA Tier 4 locomotive standard.

Drivers / Benefits

VR-series locomotives would reduce annual CO2 emissions per locomotive by 101.5 tons per year using CNG, compared to a diesel locomotive consuming 40,000 gallons per year of diesel fuel, producing 448 tons of CO2. In addition, by using RCNG made from waste streams, the LCFS provides for an 81.3% reduction of CO2 emissions per locomotive which would be 364 tons of CO2 emissions per locomotive per year.

Results / Status

Development and demonstration of a near-zero emissions locomotive. Rather than being powered by a single or multiple diesel engines, it's actually powered by multiple near-zero emissions natural gas engines. It is also capable of running on renewable natural gas, which has an 80% plus carbon reduction. The model to be used during the one-year demonstration (2018) on the Pacific Harbor Line will have the capability of running as a dual natural gas-diesel locomotive or strictly on compressed natural gas (CNG).



Project Number	SCG16310154
Start Date	2016
End Date	2018
Estimated Total Project Cost (SCG)	\$500,000
Co-funder	SCAQMD
Co-funding Amount	\$947,200
Co-funder	VeRail
Co-funding Amount	\$3,072,710
Co-funder	Others
Co-funding Amount	\$992,000
Co-funder	Pacific Harbor Lines
Co-funding Amount	\$475,000
Co-funder	POLA/POLB
Co-funding Amount	\$600,000

Clean Transportation - Near Zero Emissions Engines

Commercial Zero Emission Vehicle Roadmap

Detailed technology and economic roadmap for advanced vehicle technologies for MDV and HDV

Project Description / Objectives

The SCAQMD Commercial Zero Emission Vehicle (ComZEV) Roadmap project will develop a detailed technology and economics based roadmap for the adoption of advanced commercial vehicle technologies to reduce NOx and GHG emissions through 2050, with emphasis on the years 2023 and 2032, corresponding to Federal Clean Air Act (CAA) 8-hour ozone standards attainment deadlines. The SCAQMD ComZEV study will focus on identifying barriers and opportunities to match advanced technology options to key commercial medium- and heavy-duty vehicle vocations in Southern California.

The technology options to be evaluated include: battery electric vehicles, fuel cell vehicles, catenary/induction electric propulsion systems, and Compressed Natural Gas (CNG) and Liquid Natural Gas (LNG) internal combustion engines and gas turbines. The project will evaluate the resulting impact on fleet emissions, vehicle acquisition and operating costs for different scenarios, including, for example, market impacts resulting from different types of incentives and mandates.

Drivers / Benefits

The modeling framework will then be used to determine the impact on fleet emissions based on technology adoption rates, investigate scenarios and the effects of policy impacts, market drivers, input parameter uncertainties / sensitivity analysis on achieving NOx and GHG goals through 2050. The Technology Adoption Scenario will be enhanced through feedback from Industry and Governmental stakeholders and the incorporation of non-economic and non-technical market drivers and barriers.

Results / Status

The project will result in a baseline Technology Adoption Scenario for zero- and near zero-emissions vehicles, calibrated to the SCAQMD medium- and heavy-duty commercial vehicle fleet (including all medium- and heavy-duty vehicles). This will include the development of Total Cost of Ownership and Adoption-Rate models that are populated with data from NREL's Fleet DNA vocational vehicle duty-cycle database with an analysis of the compatibilities of candidate commercial vehicle technologies to meet the SCAQMD's air quality goals and the regions commercial vehicle requirements.

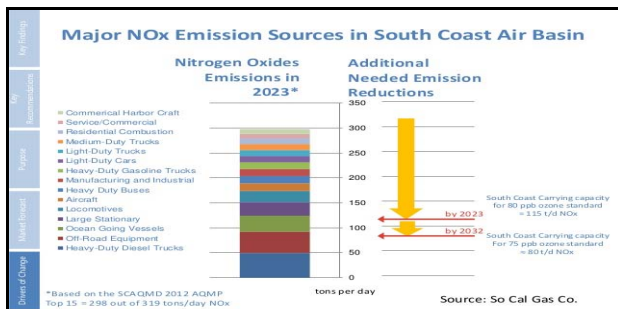

Project Number	SCG15310119
Start Date	2015
End Date	2016
Estimated Total Project Cost (SCG)	\$250,000
Co-funder	NREL
Co-funding Amount	\$250,000

Clean Transportation - Near Zero Emissions Engines

CWI 12L Development

Development of CWI 12L NZE HD Engine

Project Description / Objectives

In this endeavour, CWI will apply the technologies learned from their ISL 8.9L Near-Zero emission engine to the ISX 12L engine. It will be the first large displacement heavy duty engine capable of reaching low-NOx emissions ratings from CARB and EPA (0.02 g/bhp-hr NOx). This is 90% lower than the current CARB/EPA standards. They will advance engine and after-treatments technologies including combustion systems, air handlings, ignitions and advanced controls to achieve diesel engines efficiencies and 0.02g/bhp-hr. NOx emissions. The new development will include an optimal three-way catalyst design and formulation, specify new air handling, power cylinder, fuel system, and controls technologies and develop the engine calibration to optimize emission, vehicle performance and fuel efficiency. The CWI 12L engine will follow it's little brother, the 8.9L engine, for commercialization.

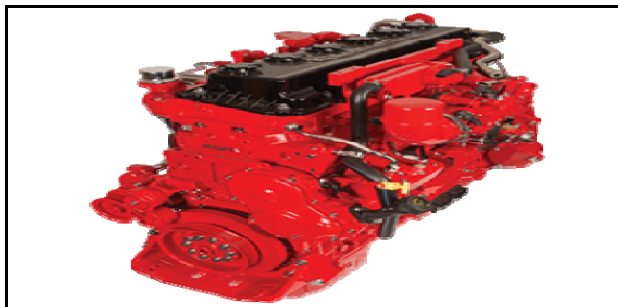

Drivers / Benefits

The emissions targets of the engines are 0.02 grams per brake horsepower-hr (g/bhp-hr) NOx and addresses methods to achieve 10 ppm or lower NH3 emission and methods to achieve minimal or zero fuel economy penalties when compared to similar 2010 certified diesel engines.

The parties believe that the CWI and Cummins proposed projects will increase the availability of low-emission natural gas engines prove significant opportunities to reduce NOx emissions from natural gas heavy-duty vehicles to the benefit of the region's air quality.

Results / Status

This project is scheduled to span three years. Beginning in 2016 and ending in 2018. However, the project will not be commercially available by the beginning of 2018. The product is being field tested by select partners. In addition to the engine launch, CWI will also develop the On Board Diagnosis components necessary for HD-OBd compliance in 2018. The product is on schedule for certification by 2017 and product launch in 2018.

Project Number	SCG15310134
Start Date	2015
End Date	2018
Estimated Total Project Cost (SCG)	\$1,000,000
Co-funder	CEC
Co-funding Amount	\$1,000,000
Co-funder	CWI/CEC
Co-funding Amount	\$1,100,000
Co-funder	Clean Energy
Co-funding Amount	\$500,000
Co-funder	SCAQMD
Co-funding Amount	\$1,750,000

Clean Transportation - Near Zero Emissions Engines

GTI - PSI 8.9L NG Engine Development

Working with Ricardo and GTI, as lead, develop a natural gas 8.9L engine.

Project Description / Objectives

The objective of this project is to develop and demonstrate a natural gas engine, and associated exhaust after-treatment technologies, that issuitable for on-road light-heavy and medium-heavy duty vehicle applications such as Class 4 to Class 7 trucks and buses. Medium- and heavy-duty on-road diesel vehicles are currently among the top ten sources of NOx emissions in the South Coast Air Basin (SCAB). These source categories are still projected to be one of the largest contributors to the NOx emissions, even as the legacy fleet of older and higher polluting vehicles are replaced by vehicles meeting 2010 emissions standards. The development of ultra-low emission natural gas engines would significantly reduce emissions from this on-road source category and assist the region in meeting federal ambient air quality standards in the coming years.



Drivers / Benefits

The benefits to develop an internal combustion engine that emits 90% lower NOx emissions, relative to current standards for heavy-duty vehicles, would approach the regional NOx emissions associated with operating an equivalent all-electric heavy-duty vehicle when taking into account the emissions associated with the electricity production. Achieving emissions targets of 0.02 g/bhp-hr NOx, 0.01 g/bhp-hr PM, 0.14 g/bhp-hr NMHC, and 15.5 g/bhp-hr CO or lower Keeping exhaust NH3 emissions as low as achievable while targeting average NH3 emissions at 10ppm or lower.

Results / Status

The project will span from 2016 through 2018. PSI has selected a production-ready, naturally aspirated, certified, CNG base engine and instrumented the cylinder heads with in-cylinder pressure sensors. PSI is making progress on engine assembly, but has cautioned that EGR mixing hardware installation will be an iterative process, as will installing and calibrating the EGR control hardware and software. Expected timing of 0.2 g/bhp-hr NOx calibration is 4-6 weeks after the engine is installed in Ricardo test cell. The engine is expected to be ready for installation at Ricardo in 2017.

Project Number	SCG1531026
Start Date	2015
End Date	2016
Estimated Total Project Cost (SCG)	\$250,000
Co-funder	Ricardo
Co-funding Amount	\$50,000
Co-funder	PSI
Co-funding Amount	\$750,000
Co-funder	SCAQMD
Co-funding Amount	\$750,000
Co-funder	PHL
Co-funding Amount	\$1,800,000

Clean Transportation - Near Zero Emissions Engines

Near Zero Emissions HD Engine Development

To co-sponsor the development of Near Zero Emissions HD Engine with SCAQMD and CEC.

Project Description / Objectives

The SCAQMD received 6 proposals for the RFP. The team (SCAQMD, CEC, DOE/NREL & SCG) selected Cummins and Cummins-Westport as the developers (contractors) for the program: Cummins Inc. (CMI) --15L engines; Spark ignition, cold EGR and 3-ways catalyst are the based technologies. They will advance engine and after-treatments technologies including combustion systems, air handlings, ignitions and advanced controls to achieve diesel engines efficiencies and 0.02g/bhp-hr. NOx emissions. Cummins-Westport (CWI) – 8.9L engines; CWI's current ISL G engine is certified with NOx and particulate matter (PM) levels below the EPA/CARB 2014 standards. The new development will include an optimal three-way catalyst design and formulation, specify new air handling, power cylinder, fuel system, and controls technologies and develop the engine calibration to optimize emission, vehicle performance and fuel efficiency.



Drivers / Benefits

The parties believe that the CWI and Cummins proposed projects will increase the availability of low-emission natural gas engines prove significant opportunities to reduce NOx emissions from natural gas heavy-duty vehicles to the benefit of the region's air quality.

Results / Status

This project is scheduled to span three years. Beginning in 2014 and ending in 2016. However, the project will not be commercially available by the end of 2016. The product would need to be field tested. CWI and Cummins initialized the demonstration of these engines at their facilities.

The emissions targets of the engines are 0.02 grams per brake horsepower-hr (g/bhp-hr) NOx and addresses methods to achieve 10 ppm or lower NH3 emission and methods to achieve minimal or zero fuel economy penalties when compared to similar 2010 certified diesel engines.

Project Number	SCG1430022
Start Date	2014
End Date	2016
Estimated Total Project Cost (SCG)	\$1,000,000
Co-funder	SCAQMD
Co-funding Amount	\$2,000,000
Co-funder	CEC
Co-funding Amount	\$4,000,000

Customer End Use Applications - Appliances & IAQ

Indoor Air Quality Assessment

Project looks at indoor air quality in tighter new home construction.

Project Description / Objectives

The focus of the proposed project is to collect and analyze IAQ-related field data and occupant perceptions from 100 new gas homes reflecting different construction types, locations and seasons to answer two key questions. 1) how are homes built to the 2008 standards performing with respect to ventilation-related criteria? 2) how can adequate ventilation (for reducing exposure) be provided while reducing infiltration related energy use? The vision of this project is to understand how natural gas homes built to the 2008 standards perform with respect to energy-related indoor air quality (IAQ). This information will be used to evaluate options for the future versions of the standards and zero-net-energy requirements.

Drivers / Benefits

Most California homes, even many recently built ones, waste a lot of energy from infiltration. Many have leaky ducts pumping large volumes of conditioned air resulting in 1/3 to 1/2 of that conditioned air escaping through those leaks. Although not efficient this situation supplies lots of air to dilute indoor-generated contaminants. Reducing that infiltration and duct leakage would save energy but risk negative health impacts due to decreased ventilation. IAQ will be assessed in a large sample of residential homes in this project.

Results / Status

In this project, approximately 100 homes will be instrumented to collect emissions data for CO₂, NO₂, VOC, PM, and formaldehyde. In 2016, approximately 25 homes in northern California were instrumented and tested. Preliminary results did not show any significant emission levels of any of the pollutants being tested for. For 2017, testing on 40 to 50 homes in southern California will be initiated. All homes selected in this study are newer homes built to 2008 building codes which require relatively tight home construction.



Project Number	SCG1421005
Start Date	2014
End Date	2018
Estimated Total Project Cost (SCG)	\$323,492
Co-funder	CEC
Co-funding Amount	\$1,250,000

Customer End Use Applications - Boilers

Ultra Low NOx Boiler

Demonstration of Ultra Low NOx Industrial Boiler

Project Description / Objectives

The purpose of this project is to demonstrate a novel Ultra-Low NOx (ULN) commercial firetube boiler technology using Dynamic Staged Entrainment (DSE) burner technology, capable of achieving NOx emissions below 9 vppm without the use of selective catalytic reduction, flue gas recirculation, or high excess air. GTI will partner with Power Flame, Inc. and with Hurst Boiler to build a prototype boiler for testing at a host site for this project.

The project team will design and fabricate a commercially viable DSE burner unit rated up to 4 MMBtu/hr. This prototype unit will be fitted to a new firetube boiler sourced to meet the needs of the host facility and installed at GTI's test facility to allow for preliminary validation testing. Following these validation tests, the burner-boiler system will be installed at the host facility and performance monitored over an extended period of time.

Drivers / Benefits

Successful demonstration and commercialization of this advanced burner technology will provide boiler operators with significant reductions in NOx emissions, reductions in green house gas emissions and reductions in fuel use through improvements in boiler thermal efficiency.

Successful completion of this demonstration will move the DSE technology towards commercialization, ultimately helping to bring to market a cost-competitive, efficient alternative for California commercial boiler operators seeking to reduce operating costs and GHG emissions, while meeting boiler NOx and CO regulations.

Results / Status

This project was selected for funding by the CEC in late 2014 to conduct a demonstration of the boiler/ burner technology at Mission Linen in Santa Barbara. In earlier project phases, a prototype burner has been designed by GTI and fabricated by the commercialization partner, Power Flame, Inc., a major US burner manufacturer. The burner /boiler was successfully installed at the end of 2016 at Mission Linen in Santa Barbara and passed its first source test. During 2017, the boiler system will be monitored to validate performance.



Project Number	SCG1520027
Start Date	2014
End Date	2018
Estimated Total Project Cost (SCG)	\$450,000
Co-funder	CEC
Co-funding Amount	\$798,788

Customer End Use Applications - Commercial Cooking

Effects of Biogas on Commercial Cooking Equipment

Study looks at safety / health impact of lower Btu (biogas) on commercial cooking equipment.

Project Description / Objectives

SoCalGas is evaluating the option of allowing producers to introduce biogas with a lower limit HHV of 970 Btu/scf. One of the main concerns is cooking safety for processes that are based mainly on time only, such as charbroilers, grills, fryers and convection ovens used in restaurants, hotels, schools and hospitals where they cook large quantities of food. Emissions of all equipment tested will be collected to establish a base line.

This study looks at the effects of reducing the Rule 30 Higher Heating Value (HHV) lower limit of 990 Btu/scf to 974 Btu/scf (biogas) on commercial natural gas cooking equipment. A key objective will be to identify a HHV upper limit that will ensure safe equipment operation with 970 Btu/scf gas. Also, CO, CO₂, NO_x, and O₂ emissions will also be collected. This is the first phase of a larger biogas study that may include evaluating issues associated with siloxanes and combustion or performance issues with natural gas equipment.

Drivers / Benefits

SoCalGas will likely inject larger quantities of biogas into our pipelines in the future in order to meet California targets for green house gas reduction (80% reduction from 1990 levels by 2050). Biogas operations have been pushing SoCalGas to relax our Rule 30 requirements which includes stringent specifications for gas quality to allow injection into our pipelines. One key area of debate revolves around minimum Btu value of gas which is set at 990 Btu/scf by Rule 30. This study will examine food safety issues that may occur if larger swings in Btu value are allowed in our gas.

Results / Status

Project was initiated in mid 2016 and should be completed by early 2017. Extensive testing on several commercial cooking equipment were completed using several gases including 1150 Btu/cu ft., 990 Btu/cu.ft. and 974 Btu/cu ft. (biogas equivalent) in 2016. Results of cooking products on convection ovens, fryers, griddles and under fired charbroilers did not show any significant difference in average internal temperatures and therefore will not likely create a safety concern. In 2017, additional testing will include higher Btu gas above 1150 Btu/cu.ft.

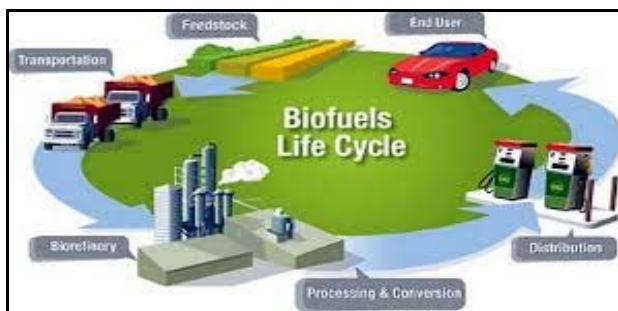

Project Number	SCG169213179
Start Date	2016
End Date	2017
Estimated Total Project Cost (SCG)	\$178,300

Customer End Use Applications - Heating & Cooling

Solar Thermal Heat Pump - Chromasun

Demonstration of Chromasun's solar thermal heat pump at a large commercial hotel.

Project Description / Objectives

Chromasun, a USA maker of solar-enhanced heating and cooling solutions for commercial and industrial facilities, has secured an opportunity, sponsored by the California Energy Commission (CEC), to select a hotel facility as the host for equipment that supplies both hot and chilled water. The Solar Thermal Heat Pump (STHP) system supplements 100% of a facility's domestic hot water. Current heating equipment remains in place in a backup role. At the same time, the STHP also produces a moderate amount of chilled water, which helps the hotel's existing chiller use less electricity.

Drivers / Benefits

Using typical assumptions of current energy prices and equipment efficiencies, the Solar Thermal Heat Pump system will save a facility nearly \$50,000 in utility costs per year (both natural gas and electricity – more as energy prices escalate in coming years). The existing natural gas boiler will remain in place at the selected test site to provide backup heating for the domestic hot water system.

A hybrid solar thermal heat pump system will reduce both NOx and green house gas emissions at the host site.

Results / Status

Chromasun completed an evaluation of baseline energy use at the JW Marriot Hotel in Palm Desert in 2014/2015 in preparation to install and monitor this solar thermal demonstration project. Also, final system designs to install the solar system at this hotel were completed in 2015 along with permitting activities with the city of Palm Desert. System installation was completed in late 2016. Monitoring is underway to validate solar system efficiency and project economics.



Project Number	SCG13500529
Start Date	2013
End Date	2016
Estimated Total Project Cost (SCG)	\$175,000
Co-funder	CEC
Co-funding Amount	\$935,100
Co-funder	Energy Concepts
Co-funding Amount	\$43,750
Co-funder	Chromasun
Co-funding Amount	\$150,289

Customer End Use Applications - Process Heating

Gas-fired Rotary Dryer

Development and demonstration of a high efficiency gas rotary dryer for food processing.

Project Description / Objectives

The goal of this project is to demonstrate and bring to the marketplace a natural gas-fired drying technology providing both cost and environmental benefits in a broad range of agricultural and industrial applications. The proposed effort is targeted to develop and demonstrate the advanced high efficient drying technology that integrates GTI's patented gas-fired rotary drum dryer (GFRD) with an innovative heat pump (HP) technology. This project has the following measurable specific objectives:

- Improve efficiency of bulk foods drying operations to over 75%
- Prove the cost-effective feasibility of successful integration of the advanced heat pump technology into industrial drying operations
- Prove the benefits and facilitate the transformation of the drying market through demonstration

Drivers / Benefits

In most cases drying is the most energy-intensive and temperature-critical aspect of food, chemical and pharmaceutical products processing. There are two major driving forces to develop improved drying operations in food processing market: low energy efficiency and high cost of the state-of-the-art drying technologies and associated equipment. Successful commercialization of this concept will provide the industry with lower capital and operating cost for industrial process drying applications.

Results / Status

The project was approved for funding by the CEC in December 2014. In 2016, a new field demonstration site was identified (Martin Feed in Corona, CA.). Facility loads were validated and the design of the Gas Rotary Dryer was customized for the operation at Martin Feed. In addition, all materials and parts for the test system were ordered. This unique dryer will be assembled and installed for testing at Martin Feed in the 4th quarter of 2017.



Project Number	SCG1520035
Start Date	2015
End Date	2018
Estimated Total Project Cost (SCG)	\$250,000
Co-funder	CEC
Co-funding Amount	\$2,600,000
Co-funder	UTD
Co-funding Amount	\$475,000

Customer End Use Applications - Process Heating

Ultra Low NOx Ribbon Burner

A high-efficiency and low NOx direct-fired ribbon burner combustion system for industrial baking

Project Description / Objectives

Ribbon burners are widely used in the industrial cooking and drying applications. These fully aerated (fully premixed) or partially aerated (partially premixed) burners use a long, thin slot filled with corrugated metal strips to create a narrow array of short interconnected flames. Ribbon burners fueled with natural gas are coming under stricter regulations in many regions of the U.S., especially in California.

The primary objective of this project is to demonstrate a new ribbon burner design developed by GTI and built by Flynn Burners in a full scale demonstration on an industrial food processing oven at Western Bagel in Van Nuys, California and to validate long term compliance with air quality regulations as required under SCAQMD Rule 1147 and rule 1153. These regulations have the most stringent NOx limits for this type of industrial equipment in the United States.

Drivers / Benefits

The proposed project uses the ribbon design adjustment to provide the conditions that enhance the radiative component of the combustion therefore evacuating the excess heat, and reducing the process temperature. The approach is expected to enable significantly improved NOx emissions without sacrificing efficiency, reliability, safety, while also being cost-effective. This development program targets a 50% reduction in NOx emissions (< 15 ppm corrected to 3% O2) that could lead to significant annual reduction of pollutant NOx emissions from equipment that use ribbon burner technology.

Results / Status

GTI and Flynn Burner Co, have completed the design and construction of the ribbon burner combustion system for installation at Western Bagel. In addition GTI completed the majority of the installation of this new technology at the end of 2016. Remaining installation tasks will be completed in early to mid 2017 pending the schedule of the host site when site production allows for additional down time to finish the installation. Additional delays in early 217 are also anticipated to address contractual issues with CEC. Full scale operation is planned for mid 2017.



Project Number	SCG1520036
Start Date	2015
End Date	2019
Estimated Total Project Cost (SCG)	\$463,375
Co-funder	California Energy Commission
Co-funding Amount	\$950,000

Customer End Use Applications - Zero Net Energy

Zero Net Energy Assessment

Project evaluates how natural gas equipment fits into Zero Net Energy residential building design.

Project Description / Objectives

The purpose of this project is to conduct a technical evaluation of the impact that upcoming Zero Net Energy regulations will have on single-family residential gas-fired equipment and how to best incorporate gas equipment into ZNE new construction. This study will assess various gas technologies and how they will be incorporated into home designs to achieve ZNE targets. Drawing on the work in the technical evaluation, the project will select several of the best equipment packages/technologies that will best meet the market needs for our service territory and to evaluate the capital, operating, and maintenance costs to design, install and operate ZNE homes within southern California.

Another objective of this assessment is to identify areas to invest future RDD funding to best meet product needs in ZNE homes.

Drivers / Benefits

In September 2008, the CPUC adopted the California Long Term Energy Efficiency Strategic Plan. The plan identifies several Big Bold EE Strategies which includes: All new residential construction in California will be zero net energy by 2020; All new commercial construction in California will be zero net energy by 2030. A ZNE Building is one where the net of the amount of energy produced by on-site renewable energy resources is equal to the value of the energy consumed annually by the building." The CEC is actively pushing for code changes to Title 24 and Title 20 to support ZNE goals.

Results / Status

Phase 1 focused on the technical and economic analysis of using natural gas equipment in zero net energy home designs. The modeling study evaluated how several baseline mixed-fuel and electric-only homes could reach ZNE goals through an optimized suite of advanced building technologies. Key findings show that mixed-fuel ZNE homes have several advantages over electric-only ZNE designs in most location/home size combinations, including: smaller PV system size, lower incremental cost, and higher Total Resource Cost (TRC) values. In 2016, Navigant's work was updated with improved input data.

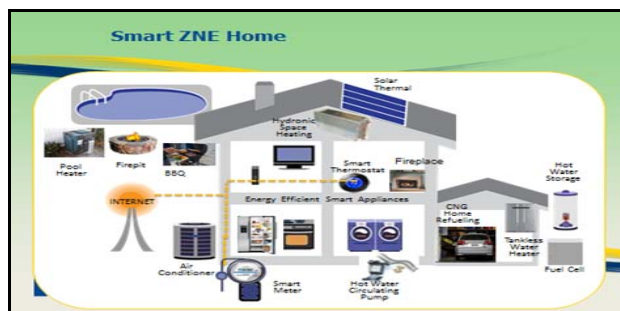

Project Number	SCG1421033
Start Date	2014
End Date	2018
Estimated Total Project Cost (SCG)	\$384,017

Appendix B – Gas Operations

Environmental & Safety - Damage Prevention

Intelligent Shutoff Device - Phases 1 & 2

Develop an intelligent shut off device for large commercial and industrial customers.

Project Description / Objectives

Develop an intelligent shutoff device and system to eliminate the release of natural gas from third party damage thereby reducing the hazard from the incident. The system is design to protect service lines to large commercial and industrial customers and is immune to varying gas loads.

The intelligent system comprises of a coaxial piping system; the inner pipe as the gas carrying pipeline and the outer pipe serving as the protective casing. Once the outer pipe is breached, the gas supply is immediately shutoff.

Drivers / Benefits

Third party damages are the primary threat to natural gas distribution systems. Service lines are particularly vulnerable to damage from third party excavators. The intelligent shutoff device and system will shutoff gas flow if the system detects the smallest thru wall damage to the outer protective casing. The goal of this project is to minimize this risk by limiting the volume of gas released from such incidents.

Primary benefit is to enhance public safety.

Results / Status

Phase 2 of the project is near completion and has produced an intelligent shut off system that has undergone several in-facility tests which have proven its ability to function as described. The next phase is to design each component to meet appropriate industry codes and gas industry requirements prior to the product becoming commercially available.



Project Number	SCG1240046
Start Date	2012
End Date	2016
Estimated Total Project Cost (SCG)	\$15,000
Co-funder	OTD Members
Co-funding Amount	\$80,000

Environmental & Safety - Emissions Detection

Advanced Leak Detection

Evaluate new and advance leak detection technologies.

Project Description / Objectives

Numerous methane emissions research activities were undertaken in this project area. The primary objectives are to assess advanced technologies to detect and quantify fugitive methane emissions to mitigate their impact on climate change and comply with existing and new environmental regulations.

Drivers / Benefits

Natural gas is being communicated as the cleanest fossil fuel and as usage increases a concern that fugitive emissions along the natural gas supply chain will contribute to an increase in climate change. Results of these research activities will provide valuable information and new tools for the Company to better assess the integrity Company assets and Customer house lines. Primary benefits are to enhance public safety and improve the environment.

Results / Status

Assessment of these technologies provide valuable performance information. Continued research in these technologies in 2017 will further identify potential applications/deployment of these tools.

Methane detection technologies include:

- 1) Los Gatos Research vehicle-based methane/ethane detection system
- 2) LaSen Helicopter-based laser methane detection system
- 3) Telops Hyper-Cam ground-based Optical Gas Imaging system
- 4) Boreal ground-based laser methane detection for perimeter/fence line applications
- 5) Residential methane detector field study
- 6) Hydrogen blend houseline leakage study



Project Number	SCG99320208
Start Date	2014
End Date	2017
Estimated Total Project Cost (SCG)	\$272,500
Co-funder	NGA/NYSEARCH
Co-funding Amount	\$383,000

Environmental & Safety - Emissions Detection

State of the Art Methane Sensors

Investigate the current state of the art in “point” methane sensors.

Project Description / Objectives

Investigate the current state of the art in “point” methane sensors and how they are used in the utility industry. A gap analysis will be performed and sensors (such as from BioInspira) may be selected for further investigation and testing based on the gaps identified. The BioInspira technology is based on the fact that some absorptive materials can react to a particular chemical species by changing color which is called colorimetry. This technology is unique and may become the next generation for detecting methane and other chemicals in natural gas.

Drivers / Benefits

With the increased awareness and scrutiny of methane emissions, there has been a corresponding increase in sensing and alert technologies. In order to properly evaluate these new technology offerings, it is necessary to first clearly define the current use cases and costs. Use cases that are currently difficult, or expensive to execute, provide insight into needs that could be addressed by new technology.

Primary benefits are enhance public safety and improve the environment.

Results / Status

1st Qtr. 2017.

BioInspira's concept utilize specific materials that react to a particular chemical species by changing color which is called colorimetry. GTI will work closely with BioInspira in order to streamline testing of the sensor in the lab. This will include predetermining dimensions of the new sensor along with digital interface requirements. Depending on the size of the sensor several existing environmental chambers at GTI can be used for the testing. These will allow for control of temperature, humidity and test gas concentrations.



Project Number	164011241
Start Date	2016
End Date	2017
Estimated Total Project Cost (SCG)	\$39,630
Co-funder	OTD Members
Co-funding Amount	\$300,000

Environmental & Safety - Emissions Quantification

Leaks from Slow Crack Growth - Phase 1

Evaluate how a leak evolves overtime due to slow crack growth on PE pipe.

Project Description / Objectives

Evaluate how a leak evolves overtime due to slow crack growth on polyethylene (PE) pipe to gain a better understanding of how this contributes to methane emissions from PE pipelines. This Phase 1 effort will focus on a first level understanding of how a crack grows in plastic material given different stress conditions and seasonal changes in ambient temperature. A large soil box will contain pressurized PE pipes with cracks initiated on the inside wall. The system is fully instrumented to monitor the time to failure from slow crack growth.

Drivers / Benefits

It is not known if leaks that develop in vintage plastic pipes remain stable, or if the leak rate increases or decreases over time. Understanding how a leak changes is important not only for safety but also for environmental reasons. A proper understanding of how leaks tend to develop over time will assist in determining how leak rates change and contribute to overall methane emissions from distribution pipelines.

Primary benefit is environmental improvement by reducing fugitive GHG emissions.

Results / Status

1st Qtr of 2017 - One of the upgraded CP Testers was commissioned and the flow test rig's control cabinet reached 98% completion. The second CP Tester is planned to be commissioned in May. Construction of the pipe sample enclosures has been delayed, but a contingency plan is in place to avoid delays in testing.



Project Number	16400223
Start Date	2016
End Date	2017
Estimated Total Project Cost (SCG)	\$343,729
Co-funder	OTD
Co-funding Amount	\$436,536

Environmental & Safety - Environmental

Center for Methane Research

Collaborative program to become the preeminent authority on the presence and impacts of methane.

Project Description / Objectives

The Center for Methane Research (CMR) will act as a liaison between industry, university researchers, government researchers, regulators, and other groups to ensure that the most important information on methane is made available while fostering collaborations.

CMR will:

- 1) Disseminate technically accurate information to members for use in communication with the press, the trade press, stakeholders and decision maker.
- 2) Collect and analyze existing data on methane emission trends and atmospheric concentration levels, including specific contributions of natural gas production, delivery, and use.
- 3) Facilitate and conduct new scientific investigations on the role of methane in global warming, with an emphasis on (1) atmospheric methane concentration and chemistry and (2) methane radiative physics, to ensure appropriate values are used for methane's existing atmospheric background concentrations, Global Warming Potential (GW) and radiative forcing.
- 4) Serve as a repository for information on the potential contribution of methane to global warming with an emphasis on the nexus with natural gas industry segments.

Drivers / Benefits

As the landscape of the energy industry continues to evolve, natural gas is playing a pivotal role in progressing towards a cleaner energy future. With growing attention directed towards global warming and carbon management, it is essential for the natural gas industry, customers and other stakeholders, that statements made about the role of methane in the atmosphere be scientifically accurate.

Primary benefit is to provide accurate information to ratepayers, policy makers and general public on the impact natural gas on climate change.

Results / Status

1st Qtr. 2017 Report.

An extensive effort to build up example documents for the types of information that the CMR will produce has begun. This includes preparation of seven scientific summary papers, one conference summary, and a white paper.

- Scientific study summaries include papers that cover topics from radiative forcing to global cycling of methane to "fat-tailed" emissions and others.
- Conference summary was for the American Geophysical Union Fall Meeting that included 70+ abstracts pertaining to methane.
- White paper was prepared to describe NOAA's Annual GHG Index.

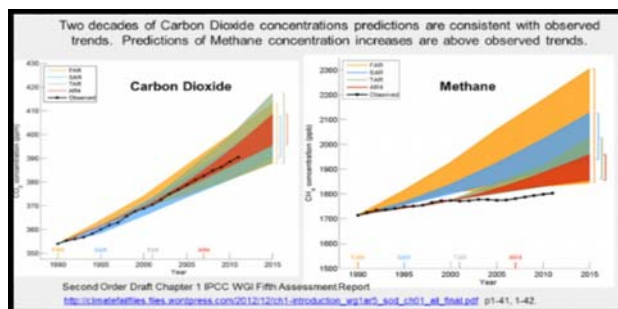

Project Number	16400258
Start Date	2016
End Date	2017
Estimated Total Project Cost (SCG)	\$25,000
Co-funder	OTD Members
Co-funding Amount	\$390,000

Environmental & Safety - Safety

Residential Methane Detectors - Phase 3

Evaluate commercially available residential methane detectors & conduct field tests.

Project Description / Objectives

Methane detection technology has advanced in recent years and some viable systems are commercially available. Their performance must be evaluated to ensure effectiveness as well as their ability to perform to specifications for reliability and accuracy. A comprehensive evaluation and testing program on commercially available Residential Methane Detectors (RMDs) will be performed. This program included evaluation of a number of variables that may influence performance and overall use of these devices. The objective of this project is to create a comprehensive program for achieving full customer adoption of cost effective, reliable, accurate and readily available RMDs. The program will include technology development and evaluation, codes and standards development, stakeholder engagement and economic and market analysis.

Drivers / Benefits

Recent events have heightened the focus on the industry's aging infrastructure and how unreported leaks can result in tragic outcomes. To prevent unreported and undetected leaks in residential homes, having an alert system such as a residential methane detector benefits both the customer and the utility. Although these systems are commercially available, their performance must be evaluated to ensure their effectiveness as well as their ability to perform to specifications for reliability and accuracy. Primary benefit is to enhance customer safety.

Results / Status

Phase I evaluated RMDs from 5 manufacturers. The goal was to determine whether these commercial products were susceptible to giving false positive responses to an assortment of typical household chemicals. Phase II expanded to include 13 manufacturers of RMDs (domestic and international units). Three domestic units from Kidde, Universal and First Alert performed better than the others. Phase III, which is ongoing, comprised of a two tier pilot field test; tier I tested 420 RMDs at customers/employee homes, tier II (ongoing) testing 200 RMDs at employee homes-to be completed in late 2017.



Project Number	SCG14400116
Start Date	2014
End Date	2017
Estimated Total Project Cost (SCG)	\$24,977
Co-funder	OTD Members
Co-funding Amount	\$538,762

Operations Technologies - O&M Technologies

Pipeline Corrosion Control

Develop and field evaluate new pipeline corrosion control technologies.

Project Description / Objectives

Perform a field test on a new pipeline corrosion protection technology powered by a fuel cell that uses pipeline natural gas as the fuel source. The field test site will be at a remote location where utility power is not available. The solid oxide fuel cell performance will be monitored during this field test period.

Drivers / Benefits

Current remote cathodic protection (CP) systems in remote locations utilize Thermo-Electric Generators (TEG) to produce DC current that will protect buried steel pipelines against external corrosion. The largest TEG has an output of 500 watts while a solid oxide fuel cell (SOFC) rectifier can produce up to 1,500 watts. The efficiency and associated operating costs of a SOFC rectifier are 10 times better than an equivalent TEG.

Primary benefits are enhanced pipeline integrity and reduce cost.

Results / Status

In late 2016, a 1,500 watt SOFC rectifier was installed at a remote desert location adjacent to an existing TEG site. The size and footprint of the SOFC rectifier is significantly smaller than an equivalent TEG. A one-year field test is being performed to assess its performance and reliability under different seasonal conditions.



Project Number	SCG99320209
Start Date	2016
End Date	2017
Estimated Total Project Cost (SCG)	\$80,000

System Design & Materials - Compressor Technologies

Compressor Zero Zero Program (CPS-14)

Use advanced diagnostic systems and performance assurance to achieve emission compliance/reduction.

Project Description / Objectives

Program to follow-up on technologies previously identified in the Emission Reduction of Legacy Engines (ERLE) program. This project focuses on compliance and performance assurance rather than emission reduction. SoCalGas' interest is in developing advanced diagnostics that can be used in a Continuous Engine Performance Monitor (CEPM) system.

Drivers / Benefits

Smaller, less experienced workforce and more stringent air quality regulation would benefit from an advanced diagnostic system. Compare this to On Board Diagnostics (OBD) used in the automotive market. Like with OBD, diagnostic systems could reduce compliance costs by reducing emission testing frequency or even the need for Continuous Emission Monitoring Systems (CEMS).

Results / Status

The project was delayed due to the inability to find a test site for 4-stroke engines. Some testing was completed on 2-stroke engines, but further analysis and testing is required.



Project Number	SCG1440015
Start Date	2014
End Date	2017
Estimated Total Project Cost (SCG)	\$25,000

System Design & Materials - Compressor Technologies

PRCI Compressor Ambient NO₂ Modeling (CPS-11-5)

Compare ambient NO₂ measurements to air dispersion model known to yield erroneous concentrations.

Project Description / Objectives

Collect data and compare ambient NO₂ measurements to air dispersion model, in order to improve the dispersion model. Co-funders include INGAA, INGAA Foundation, and API.

Drivers / Benefits

The new 1-hour NO₂ National Ambient Air Quality Standard could require unnecessary NO₂ reductions because of problems thought to exist with the EPA's Air Dispersion Model. This project will collect ambient NO₂ measurements taken from the compressor and compare them to estimates based on the EPA's air dispersion model. The objective is to improve the accuracy of estimates calculated by the dispersion model.

Results / Status

This multi-year project is being conducted at Kinder Morgan's Balko Compressor Station. Instrumentation to collect meteorological data was installed in 2015 including wireless communications hardware. Data collection was completed in 2016. The final report is under development.

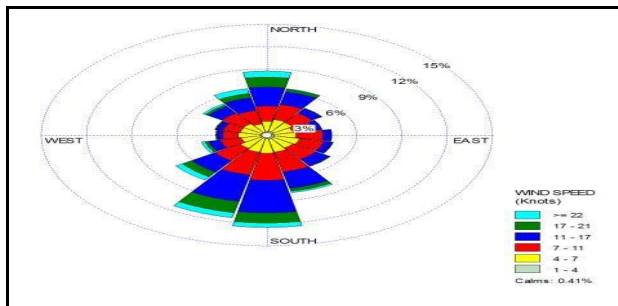

Project Number	SCG1440012
Start Date	2014
End Date	2017
Estimated Total Project Cost (SCG)	\$195,922
Co-funder	INGAA & API
Co-funding Amount	\$275,000
Co-funder	PRCI Members
Co-funding Amount	\$955,000

System Design & Materials - Engineering & Design

Corrosion Assessments Model (EC-2-7)

Reduce model driven uncertainty in failure pressure and remaining life predictions for assessments.

Project Description / Objectives

Reduce model driven uncertainty in failure pressure and remaining life predictions for internal and external corrosion assessment. Identifying that replacing AYS by SMYS is a fundamental cause of model error that remains in B31G and Modified B31G provides a rational basis to redefine B31G and Modified B31G to offset this bias in applications to “modern” pipe.

Drivers / Benefits

Benefits accrue through decreased uncertainty, which in turn results in increased safety for a given dollar invested in maintenance. Hard dollar value accrues through reduced model driven uncertainty in both failure pressure and remaining life for internal and external corrosion assessment. That benefit accrues to liquid as well as gas pipelines, and does so without regard to system age (or grade of steel). This results in maintenance that has value in reduced risk, while eliminating maintenance driven by uncertainty.

Results / Status

The draft final report was received July 2016 indicating factors such as the ratio between diameter, wall thickness and width of corrosion patch. A conservative model bias was introduced in B31G and modified B31G equations, which drive maintenance decisions. The large conservative bias in predicted failure pressure can lead to mitigation measures that do not affect nor improve safety or reduce risk in post 1960 steel pipe, which translates to a significant number of digs and local repairs. A new contract was awarded to perform field tests to validate the results of the project.

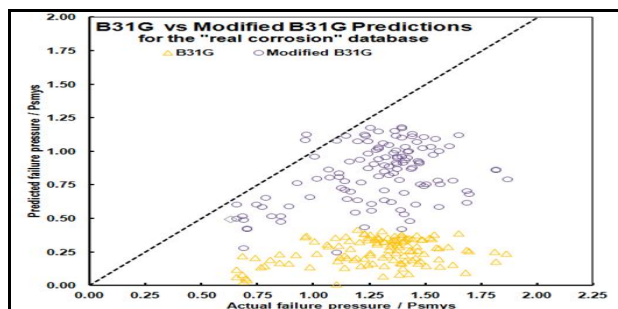

Project Number	SCG1440038
Start Date	2014
End Date	2017
Estimated Total Project Cost (SCG)	\$48,350
Co-funder	PRCI Members
Co-funding Amount	\$500,000

High-Low Misalignment Girth Weld Flaw Acceptance (MATH-5-2)

Develop acceptance criteria for girth welds with high-low misalignment.

Project Description / Objectives

Develop an accepted industry guideline for addressing high-low misalignment in new construction, and in fitness for service determinations for existing pipelines. Produce verifiable experimental test data (with flaw and high-low misalignment interaction) that will assist the development of a refined methodology for the accurate and consistent assessment of high-low misalignment.

Drivers / Benefits

Code based weld flaw assessment methods are silent or provide only minimal discussion of weld high/low misalignment. Misalignment leads to increased likelihood of weld flaws in the root region and creates a stress concentration. Repairs on deep flaws are problematic as they have much higher risk of hydrogen cracking particularly for X70 or higher grades.

Benefits include:

- Lower construction costs by reducing unnecessary repair of weld flaws.
- Lower construction costs by avoiding hydrogen cracking and hydrotest failures due to repair of deep weld flaws.

Results / Status

Phase II is complete, and a first final draft report is ready for review. Recommendations suitable for industry standards are currently under development as part of Phase III and work with standards committees such as API1104 is also underway to incorporate those recommendations, as part of Phase IV. Impact of misalignment on thin-wall pipes is also part of Phase IV.

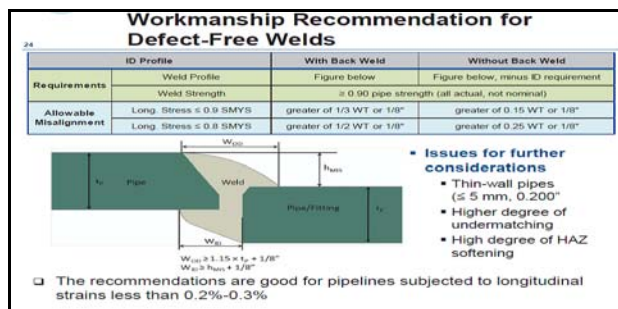

Project Number	SCG1340075
Start Date	2013
End Date	2017
Estimated Total Project Cost (SCG)	\$1,093

System Design & Materials - Engineering & Design

PRCI Improve ECDA Performance (EC-1-12)

Improve ECDA performance by reviewing past practices and lessons learned.

Project Description / Objectives

The objectives of the study were to identify leading practices and gaps associated with either the ECDA process or the application of the process. In addition, the overall effectiveness of the process has been evaluated based on available information and metrics collected. The study included:

- A literature search for key publications regarding performance and effectiveness.
- Collection of operator ECDA process information.
- Interviews with selected Operators.
- Interviews with leading Service Providers.
- Review leading industry procedures, specifications, and standards.
- Review available performance metrics, including data reported to and by PHMSA.

Drivers / Benefits

The final report will provide specific findings and recommendations to operators on improvement items for the ECDA process based on results to date. The ECDA methodology has been utilized as an integrity assessment method since 2004. By reviewing industry data (including PHMSA performance metrics data) and incorporating lessons learned from member companies, gaps, trends, lessons learned, and best practices will be identified for ECDA performance enhancements.

Results / Status

This project is complete. The final report was issued in May 2016. The results of the project show that the ECDA processes used by the Sempra Utilities to inspect its pipeline meet or exceed industry standards. This report provides a useful industry-accepted reference document that lays out acceptable ECDA practices.

Incidents Where Pressure Testing Was Previously Conducted						
Incident Year	Company	Pressure	Test Year	MAOP	EC/IC	Type
2012	Sea Robin	1941	2009	984	IC	Pinhole
2012	Buckeye	1363	2007	800	EC	Pitting
2011	Trunkline	1941	2009	1182	IC	Pinhole

Incidents Where DA Was Previously Conducted					
Incident Year	Company	DA Year	EC/IC	Type	At Dig Site
2011	PG&E	2011	EC	Pitting	Cased, Under Pavement

Project Number	SCG1340068
Start Date	2013
End Date	2016
Estimated Total Project Cost (SCG)	\$26,985
Co-funder	PRCI Members
Co-funding Amount	\$344,633

System Design & Materials - Engineering & Design

Standardization of Weld Test Methods (API-2-1)

Develop girth weld guidelines based on Single Edge Notched Test, fracture toughness measurements.

Project Description / Objectives

Develop girth weld guidelines based on Single Edge Notched Test, fracture toughness measurements in tension. Companies will have material properties information to support strain based design and improve flaw acceptance criteria.

Drivers / Benefits

Use of these test methods is a necessity for strain-based design of pipelines, as industry moves towards high grade pipe materials. 1. Strain-based design and stress-based design of high grade pipelines will require the understanding of tensile properties of weld metal. 2. Low-constraint test methods are useful for strain-based design and for ECA of welds in cold-weather construction.

Results / Status

The results from the round robin program showed a large number of the test data did not meet the validity requirements, significant because the majority of labs involved are familiar with the RR test program. As a result, the decision was made to review and revisit the data modifying the evaluation criteria, relaxing the final crack growth predictions and assessing the impact on resistance curves and final crack size prediction. The resulting evaluation of the impact of relaxation of the validity requirements on the subsequent resistance curves will be analyzed to determine effectiveness.

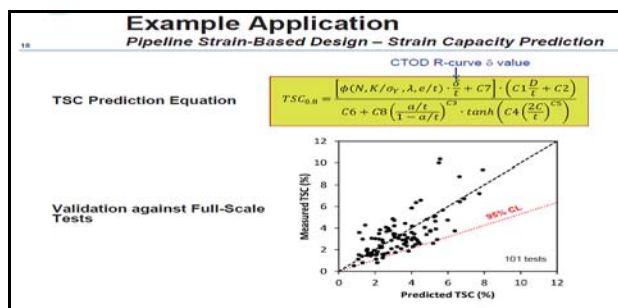

Project Number	SCG1340076
Start Date	2013
End Date	2017
Estimated Total Project Cost (SCG)	\$31,511
Co-funder	PRCI Members
Co-funding Amount	\$325,322
Co-funder	PRCI Members 2017
Co-funding Amount	\$70,800

System Design & Materials - Gas Composition & Quality

Hydrogen Gas Blend Storage Field Impacts

Test potential impacts on storage field subsurface structure from hydrogen blended gas supplies.

Project Description / Objectives

Evaluate impacts from the introduction of hydrogen in natural gas on storage field substructure integrity. The USC School of Engineering will conduct both literature searches and laboratory experiments to determine the effects on reservoir integrity (storage and cap rock) as well as substructure materials such as cements and steel. Pending results from this study, subsequent analysis and experiments may be performed.

Drivers / Benefits

California must reduce greenhouse gas emissions dramatically in the next 40 years. Achieving this goal requires the reduction of carbon intensity of fuels such as natural gas. One solution to decarbonize the energy supply is to introduce low carbon fuels into the natural gas pipeline infrastructure. This would include the blending of hydrogen, produced through electrolysis or steam reforming, into the existing natural gas pipeline. Understanding the impacts of this blend to the natural gas infrastructure enables SoCalGas to assess low carbon fuel delivery potential.

Results / Status

Literature searches found limited work on the actual mechanisms at work for the effects of hydrogen in natural gas blend on subsurface materials. Theoretical models indicate that the possibility of stratification of gases in the reservoir should not be a concern. Laboratory testing of hydrogen/natural gas blend at high pressures were performed on storage caprock and cement samples. Evaluation of permeation effects did not reveal a consistent trend. Although material changes were observed the causes were not readily apparent or explained. Further testing with oil/brine mixtures is necessary.

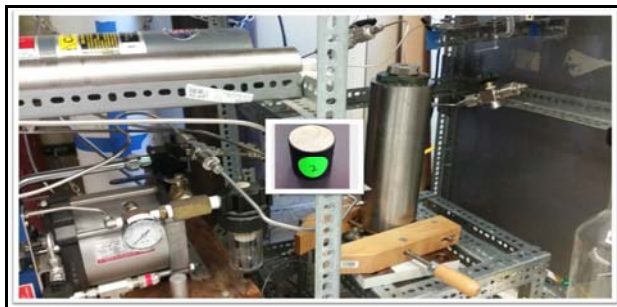

Project Number	SCG1440018
Start Date	2014
End Date	2016
Estimated Total Project Cost (SCG)	\$200,000

System Design & Materials - Gas Composition & Quality

Universal Analytical Technique for Siloxane

Develop a universal sampling and analysis procedure for measuring siloxanes in biomethane.

Project Description / Objectives

Develop a universal, industry-wide sampling and analysis procedure for measuring siloxanes in biomethane that can obtain a detection limit of 0.01 mg/M3 of silicon or less. Various sampling collection methods (grab sample, liquid impinger, solid absorbent) and analytical techniques (GCAED, GC-MS, FTIR) will be tested for off-line analysis to determine the best options for precision, accuracy, and sensitivity.

Instrumentation for on-line analysis of siloxanes will also be researched and, if feasible, tested in conjunction with off-line analytical tests. The results of this study will be submitted to ASTM for consideration as a published standard, allowing the industry to adopt a common practice for determining siloxane content in Renewable Natural Gas (RNG) sources.

Drivers / Benefits

With the growth of RNG production expected to continue in California, New York, and other markets in the US, it is expected that additional states will look to establish RNG pipeline specifications similar to those recently established in California. Producers, regulators and utilities would benefit from validated and standardized measurement methodologies which meet these new, lower specifications.

Results / Status

1st Qtr. 2017:

Major results of the on-line analytical instrumentation literature search produced:

1. 5 mfrs currently offer analyzers for on-line siloxane analysis
2. 3 of 5 meet the majority spec.
3. 6 alternative products may be capable of the application with development & customization
4. IR-based spectrometers are the most popular solution
5. GC-IMS-SILOXTM is the most balanced option; portability, cost, and analytical spec.
6. AtmosFIR provides most precise data
7. Antaris IGS & AtmosFIR are the fastest
8. Photovac Voyager GC has lowest detection level



Project Number	164315242
Start Date	2016
End Date	2017
Estimated Total Project Cost (SCG)	\$73,553
Co-funder	OTD Members
Co-funding Amount	\$223,000

System Design & Materials - Materials and Equipment

Diagnostics Estimation Ultrasonic Meter (MEAS-6-20)

Review studies on causes of changes in diagnostic data and its impact on measurement uncertainty.

Project Description / Objectives

Develop a process to evaluate if changes in Ultrasonic Meter flow related diagnostics (e.g. profile factor, asymmetry and swirl) are causing a significant change in the estimated installed measurement uncertainty of the Ultrasonic meter station.

Drivers / Benefits

AGA-9 currently requires the additional uncertainty due to installation effects to be less than +/- 0.3%. Identification of the cause of changes in diagnostic parameter changes between calibration facility base line diagnostics and the meter first flow base line diagnostics can be used to minimize installation measurement uncertainty effects and to quickly identify if remedial action is required to address diagnostic parameter changes due to changes in operating conditions.

Results / Status

Draft Final PRCI Report PR-352-15600 from Contractor RANS Solutions was issued in July 2016 but never published. Review and analysis of a number of Ultrasonic meter test data sets and published papers (i.e. Effect of Upstream Piping Configurations On Ultrasonic Meter Bias by TransCanada Calibration) led to development of a common set of Gaussian quadrature velocity diagnostic parameters and an uncertainty model based on their change. Contractor was awarded a 2nd 1 year contract PR-352-16603 in September 2016 to complete additional research recommended in draft report.

Relational Diagnostic Matrix	Performance	Automatic Gain Control (AGC) (per Path)	Signal to Noise Ratio (SNR) (per Path)	Speed of Sound (SoS) (per Path)	Flow Velocity (per Path)	Reflection Coefficient	Standard Deviation	Footprint
Ultrasonic Meter Operating Diagnostics								
Transducer Failure	X	X		X	X			
Detection Problems	X	X		X	X			
Meter Timing Problems				X				
Ultrasonic Meter Process Condition Change Diagnostics								
Fouling	X	X	X	X	X			
> Bottom Fouling				X			X	X
> Asymmetrical Fouling				X	X			X
> Symmetrical Fouling		X		X	X	X	X	
> Fouling on Transducers		X						X
> Liquid Contamination			X					
Ultrasonic Noise	X	X	X					
High Velocity	X	X	X					
Ultrasonic Meter Calibration Transferability and Process Condition Change Diagnostic								
Change in the Flow Profile					X			
Process Conditions - Pressure			X					
Process Conditions - Temperature				X				

Table 1 – Ultrasonic Meter Relational Diagnostic Matrix

Project Number	SCG1540086
Start Date	2015
End Date	2017
Estimated Total Project Cost (SCG)	\$18,990
Co-funder	PRCI Members
Co-funding Amount	\$283,000

System Design & Materials - Materials and Equipment

In-Situ Proving Ultrasonic Meters (MEAS-6-17)

Identify potential techniques to in-situ proving of ultrasonic meters within 0.5-1% accuracy.

Project Description / Objectives

Conduct Phase I paper study to identify potential techniques to in-situ prove ultrasonic meters within 0.5-1% accuracy.

Drivers / Benefits

Reduced measurement uncertainty and therefore LAUF. Also reduced maintenance and operating costs resulting from less frequent meter recalibrations that cost \$25k for 12" meter.

Results / Status

Published Final PRCI Report PR015-15605 from Contractor SWRI was issued in May 2016. Report contained several techniques that are suitable for research and development within 1 - 3 years (i.e. Hot Wire Anemometer and Pitot Tube Array).

Preliminary Ranking: Top Scores								
CONCEPT	EVALUATION CRITERIA							SCORE
	Safety Concerns: 7	Pipe Diameter Dependency: 3	Modification(s) Needed: 4	Flow Additives Required: 1	Implementation Sensitivity: 5	Time to Market: 2	Expected Accuracy: 6	
Particle image velocimetry	3	3	2	2	3	1	3	75
Pitot tube array	3	2	2	3	3	2	3	75
TOF: Injection of hexane/argon	3	1	3	2	3	3	2	71
Laser sheet particle velocimetry	3	2	2	2	3	2	2	68
Hot-wire anemometer	1	2	3	3	3	3	3	67

Project Number	SCG1540084
Start Date	2015
End Date	2016
Estimated Total Project Cost (SCG)	\$15,000
Co-funder	PRCI Members
Co-funding Amount	\$70,800

System Design & Materials - Materials and Equipment

Integrated Expert Monitoring for Butt Fusion

Identify the fusion boundaries that would lead to sub-standard butt fusions.

Project Description / Objectives

Construct a bench top, fully instrumented and controlled butt-fusion machine that can explore the limits of fusion parameters (pressure, temperature, time) that will produce acceptable and sub-standard fusions. This will serve as a pre-production prototype unit that can be licensed to a manufacturer.

Drivers / Benefits

When joining PE pipe using the butt fusion process, it is critical that fusion parameters impacting the integrity of the joint is maintained within acceptable boundaries. This will ensure long-term performance under operating conditions. Primary benefits are enhanced PE pipeline integrity and public safety, and reduce cost.

Results / Status

The two phased project has been completed. The insights developed from this body of work were not available to operators prior to this work, which has provided a solid data set with well-defined confidence bounds. An extremely large and detailed set of fusions was executed, followed by rigorous and comprehensive testing that was focused on lifetime prediction.

The project results clearly show that any of the internationally accepted fusion procedures are capable of producing good quality joints with greater than 93% confidence.



Project Number	SCG1240045
Start Date	2012
End Date	2016
Estimated Total Project Cost (SCG)	\$55,750
Co-funder	OTD Members
Co-funding Amount	\$404,250

System Design & Materials - Materials and Equipment

PE Pipeline Technology

Develop processes to enhance the integrity of the polyethylene pipeline system.

Project Description / Objectives

Assess new technologies and methodologies that can be utilized to better conduct quality control assessment of new PE pipe material received from manufacturers to ensure they meet company requirements. These technologies will provide a cost-effective method of performing quality control assessment of new PE pipe.

Drivers / Benefits

These technologies will provide a cost-effective means of enhancing the Company's ability to perform quality control assessment of new PE pipe material and address material anomalies. Primary benefits are reduced costs, ensure PE pipe quality, enhance pipeline integrity and public safety.

Results / Status

The Engineering Analysis Center acquired an Olympus digital ultrasonic thickness gauge that can be customized to measure wall thicknesses of non-metallic materials such as PE pipe. The digital UT gauge allows the technician to perform measurements faster and along the entire pipe length, whereas the current instruments are only able to measure at the pipe ends. A comparative assessment will be performed with the digital UT gauge against a calibrated micrometer on PE pipe sizes 1/2" to 8".



Project Number	SCG97320401
Start Date	2015
End Date	2017
Estimated Total Project Cost (SCG)	\$54,000

System Design & Materials - Materials and Equipment

PRCI Ultrasonic Flow Installation Effects (MEAS-6-18)

Review studies on measurement impacts from installation effects under a wide range of conditions.

Project Description / Objectives

Conduct a comprehensive literature search and review on the installation effects of ultrasonic flow meters. Prepare a report detailing gap analysis, a review of trends within the data, and recommendations for future research areas based on these analyses.

Drivers / Benefits

This research should provide a searchable library of studies related to installation design and practices of Ultrasonic meters. The goal is to reduce metering errors that are already lower than 1% even further as this can represent millions of dollars in lost revenue when installed in high capacity locations.

Results / Status

A significant amount of installation effects research on Ultrasonic flow meters has already been conducted by manufacturers and others, including GRI and PRCI. Variations in pipe configuration, line size, and meter type, using state-of-the-art experimental and analytical studies and computational fluid dynamics, were successfully compiled and summarized. In Final published PRCI Report PR-015-15602 issued in January 2016, SwRI found dirty and corroded meter tubes and blocked and rotated flow conditioners to affect meter performance.

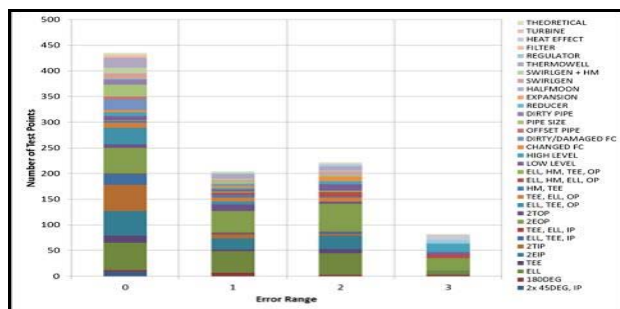

Project Number	SCG1540085
Start Date	2015
End Date	2016
Estimated Total Project Cost (SCG)	\$4,839
Co-funder	PRCI Members
Co-funding Amount	\$70,800

System Design & Materials - Materials and Equipment

Pulsation USM Effects (MEAS-5-24A)

Examine relationships between USM acoustic and flow pulsation frequencies and meter accuracy.

Project Description / Objectives

Further examine relationship between ultrasonic gas meter signal repetition rate and duration, the frequency of pulsations generated by reciprocating compressors, and ultrasonic gas meter accuracy. Also identify the pulsation frequency and amplitude ranges where the accuracy of the USMs under test are unaffected by pulsations. Use the results to improve natural gas meter station design practices.

Drivers / Benefits

Diagnostics and flow data collected from the meters was analyzed, and a useful relationship found between the pulsation conditions and the meter measurement error. Findings used to recommend a basis for installing ultrasonic meters in gas pipelines with varying pulsations. Additional testing evaluated a fast-response differential pressure transducer connected across a plate flow conditioner as a potential pulsation diagnostic tool.

Results / Status

PRCI published Final Report PR-015-15601 from Contractor SWRI in April 2016. Over the range of 1 to 45 Hz., it was found that meter performance depends on the amplitude of peak-to-peak velocity pulsations at the meter. Also confirmed manufacturer changes to the meter's digital signal processing algorithms and gain control reduced the error caused by pulsation.

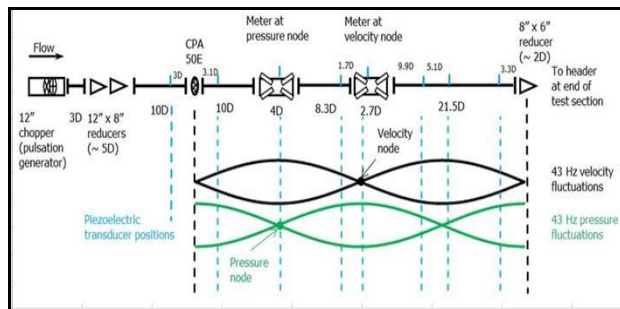

Project Number	SCG1540083
Start Date	2015
End Date	2016
Estimated Total Project Cost (SCG)	\$17,429
Co-funder	PRCI Members
Co-funding Amount	\$154,580

System Inspection & Monitoring - Pipeline Inspection Technologies

AC Earth Faults

Develop methods to quantify which buried gas pipes are exposed to ground (or earth) faults.

Project Description / Objectives

Develop methods to quantify the extent to which buried gas pipes are exposed to ground (or earth) faults in nearby AC power systems and to examine the risks caused by this exposure. These fault events have the energy to damage pipelines and coatings.

Drivers / Benefits

The transient nature of AC earth faults presents the risk that damage can occur and go unnoticed for a significant period. Ground faults between gas and other infrastructures also pose risks but on a much slower time scale. A system that can proactively indicate where earth faults are likely to occur has value. The response can be to build in appropriate mitigations or to investigate identified problem areas.

Primary benefits are enhanced pipeline integrity and public safety.

Results / Status

1st Qtr. 2017

Development began on the three major components of the predictive risk model; these are:

- A BPMN model that captures the process steps for setting up and running the risk model.
- A physics model that predicts the current and voltage levels on the pipeline over various parameter ranges.
- A risk model that uses inputs from the BPMN model and calculated values from the physics model to quantify the pipeline risk for a given set of inputs.

Prototype versions of these components have been constructed and tested using published data.

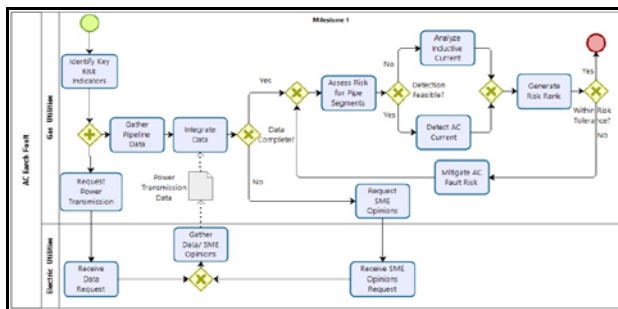

Project Number	164411296
Start Date	2016
End Date	2018
Estimated Total Project Cost (SCG)	\$70,000
Co-funder	OTD Members
Co-funding Amount	\$219,200

System Inspection & Monitoring - Pipeline Inspection Technologies

ERW Pipe Integrity Management (IM-3)

Provide operators with guidance on integrity management of longitudinal seam welded pipe.

Project Description / Objectives

Provide operators with guidance on integrity management of longitudinal seam welded pipe. This project has been divided into four sub-projects.

Drivers / Benefits

Inspection of longitudinal seams for flaws and eliminate potential for pipe failures.

Results / Status

Contract executed. 2016 milestones:

IM-3E: Effects of Hydrostatic Testing on ERW Pipe Seam Anomalies: A Final Report was issued for this project that provides Guidelines for performing hydrostatic testing, applicable to all pipe types, taking into account the detrimental effects of hydrostatic testing on ERW seams, while minimizing unnecessary damage to benign resident defects.

IM-3-2: ERW Fatigue Life Integrity Mgmt Improvement– Supplemental Full-Scale Testing for Model Validation: Project is performing full-scale testing to validate existing fatigue life models.

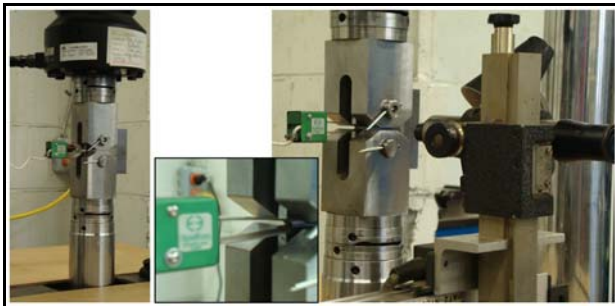

Project Number	SCG1540078
Start Date	2015
End Date	2017
Estimated Total Project Cost (SCG)	\$15,000
Co-funder	PRCI Members
Co-funding Amount	\$1,150,000

System Inspection & Monitoring - Pipeline Inspection Technologies

Integrity Assessment of Difficult-to-Inspect Pipelines (NDE-3-2)

Integrity assessment of difficult-to-inspect pipelines by using high resolution NDE.

Project Description / Objectives

The objectives of the study were to evaluate state of the art non-destructive examination (NDE) technologies for use on pipeline segments that cannot be made piggable. A determination will be made of the Technology Readiness Level of NDE technologies for their use in partial inspections of pipe segments. The evaluation of NDE technologies will include an assessment of the capabilities and limitations of each tool and technology. This first phase of the project evaluated a variety of tools utilizing the following technologies:

- Digital Radiography and Computed Tomography (CT)
- Eddy Current
- Low Frequency Ultrasonics
- Large Standoff Magnetometry

In addition, the study will work to establish quantitative criterion for accepting/rejecting pipeline segment fitness for service based on limited inspection locations and NDE performance as part of an overall Performance Acceptance Test for the NDE tools and technologies that are part of the study. As part of the results of the study, performance measures for probability of detection (POD), probability of identification (POI), accuracy and resolution will be determined for each technology.

Drivers / Benefits

At the conclusion of this study, operators will have a qualitative and quantitative evaluation of available NDE tools and technologies that could be used for partial inspection of pipe segments. This evaluation will include the capabilities and limitations of each tool that can be applied to a variety of pipeline segment conditions. The project will also provide operators quantitative performance criteria that can be used to determine which tools meet the operator's requirements for performance measures such as POD, POI, accuracy, and resolution.

Results / Status

Technology readiness summaries for on-shore and sub-sea applications have been completed. The next stage includes field testing of technologies identified during the Technology Readiness Level assessment. Work in this stage will focus on determining the effectiveness of the technologies as well as obtaining data for Extreme Value Analysis (EVA). EVA is a branch of statistics dealing with extreme variations from the median of a probability distribution. EVA would be used to estimate the maximum depth along the extent of the pipeline, as well as the probability of exceedance of a target depth



Project Number	SCG1540079
Start Date	2015
End Date	2017
Estimated Total Project Cost (SCG)	\$41,000
Co-funder	PRCI Members
Co-funding Amount	\$342,500

System Inspection & Monitoring - Pipeline Inspection Technologies

NYSEARCH Robotics Crack Sensor

Develop an EMAT and TMFL sensor on the robotics platform for crack and mechanical damage inspection.

Project Description / Objectives

Develop a combination EMAT (Electro Magnetic Acoustic Transducer) and TMFL (Transverse Magnetic Flux Leakage) sensor on the robotics platform for internal crack and mechanical damage pipeline inspections. Crack detection has been identified by regulators as a critical pipeline integrity need for enhancing pipeline safety.

Drivers / Benefits

The traditional emphasis on pipeline integrity has been to identify corrosion using MFL tools that measure wall loss. However, new inspection tools are needed to detect potential cracks and other flaws in long seams and girth welds that lead to pipeline failure. NYSEARCH received co-funding from PHSMA to develop and test a TMFL and EMAT inspection tool to fill the technology gap.

Results / Status

Field demonstration of the crack sensor took place in 2015. This program was successfully completed in February 2016 with the commercialization of the crack sensor through Pipetel Technologies, the company that has already established an excellent record in commercializing the Explorer family of robotic devices.

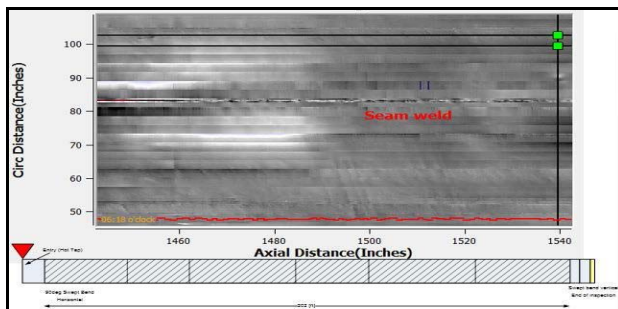

Project Number	SCG1240066
Start Date	2013
End Date	2016
Estimated Total Project Cost (SCG)	\$187,000
Co-funder	NYSEARCH
Co-funding Amount	\$1,200,000

System Inspection & Monitoring - Pipeline Inspection Technologies

NYSEARCH sUAS Technology Assessment

Evaluate the use of Small Unmanned Aerial Systems (sUAS) for mobile methane leak detection.

Project Description / Objectives

This NYSEARCH led project evaluates the potential use of Small Unmanned Aerial Systems (sUAS) for leak detection and surveying in gas maintenance operations. Various UAS vendors will be reviewed for robustness and safety. The Federal Aviation Administration (FAA) and other regulatory requirements will be reviewed and flying exemptions submitted for gas operational use. Demonstrations of UAS capabilities will be conducted. In later phase, deployment and testing of state-of-the-art leak detection sensors on the UAS are envisioned.

Drivers / Benefits

Unmanned Aerial Systems adapted for gas leak detection and high definition camera images of difficult to inspect locations could enhance various maintenance operations. Technical advancements in cameras, sensors, and communications now make it feasible to utilize them in UAS systems. Of particular interest is developing an aerial leak detection system. However, it is critical to follow regulations and operate UAS systems safely.

Results / Status

5 different inspections were performed for multiple utilities including pipelines on bridges, ROW, and M&R facilities utilizing video imagery which has shown promise as an application. Pergam unit was tested onboard UAS for leak detection capabilities. Preliminary results did not look favorable. Additional development is needed and will be continued in 2017.

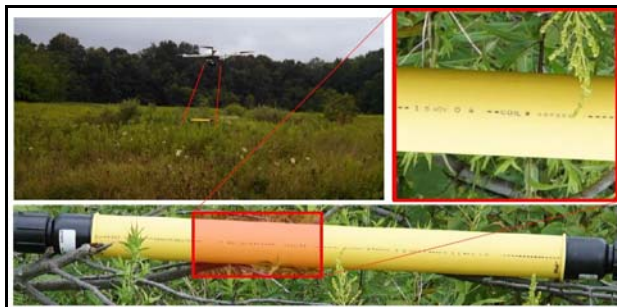

Project Number	SCG1440067
Start Date	2014
End Date	2016
Estimated Total Project Cost (SCG)	\$29,505
Co-funder	NYSEARCH
Co-funding Amount	\$200,000

System Inspection & Monitoring - Pipeline Inspection Technologies

NYSEARCH Tech Evaluation & Testing for Quantifying Leaks

Test & verify the accuracy of emissions rate surveying systems being considered for leak repair.

Project Description / Objectives

NYSEARCH is comparing and testing methane leak quantification technologies and survey methods/protocols. The goal is to verify vendor's claims on measuring leak rates from natural gas facilities. This project builds on a separate NYSEARCH effort that involved testing of emerging mobile leak detection and survey systems. PHSMA reviewed the project plan and approved co-funding in 2015.

Drivers / Benefits

There are many claims to state-of-the-art leak detection and quantification technologies in the market. Organizations have used these technologies to estimate the number of service area leaks and total annual emissions. Based on our experience, the accurate quantification of leak flow rates needs further development and analysis. An independent and systematic comparison of methane leak detection technologies and methods should improve the industry's leak quantification efforts.

Results / Status

Thr Simulated gas leaks were measured by each vendor over a few days and quantification of each gas leak was submitted. A comparison of results showed large statistically significant errors in the accuracy of measured leak rates. The vendors indicated that they learned a lot from the test and improvements to their system made. A second test of simulated leaks were measured by three technology providers at a SoCal facility inthe vendor's system was conducted at a SoCalGas facility in 2016. Field test demonstrations were completed in 4th quarter of 2017 and results continued to show significant



Project Number	SCG1540090
Start Date	2015
End Date	2017
Estimated Total Project Cost (SCG)	\$19,540
Co-funder	NYSEARCH
Co-funding Amount	\$122,000
Co-funder	PHSMA
Co-funding Amount	\$144,700

System Inspection & Monitoring - Pipeline Inspection Technologies

Pipe Properties Using ILI (NDE-4)

Develop and validate pipe properties where data are missing or incomplete using ILI technologies.

Project Description / Objectives

The confirmation of Maximum Allowable Operating Pressure (MAOP) of all pipelines regardless of vintage through traceable, verifiable, and complete records has become a critical focus of pipeline integrity activities. This research project will develop and validate analytical models that measure pipe properties in instances where data may be incomplete or missing. Extensive use of data from In-Line Inspection (ILI) runs will be used.

Drivers / Benefits

While the current ILI technologies provide high resolution data that is relied upon as the backbone of most integrity management programs, improvements are needed in characterizing features, flaws, imperfections, and stresses and strains in pipelines and related seam and girth welds. Among the technology enhancements under investigation is the ability of ILI to determine pipe properties. If viable, such capability would augment engineering evaluations, and help supplement missing pipeline records to address the increasing regulatory demand for traceable, verifiable, and complete records.

Results / Status

A Final Report is nearing completion. This is an on-going multi-year program with multiple project tasks. Building upon previous work, ILI vendors performed a blind evaluation of pipeline inspection data. It was shown that ILI is a viable tool to verify operator databases based on physical attributes, but determination of properties such as material grade was not possible in this work scope. An additional work phase and continuing research regarding data pattern recognition are proposed to move towards identification of pipe grade.

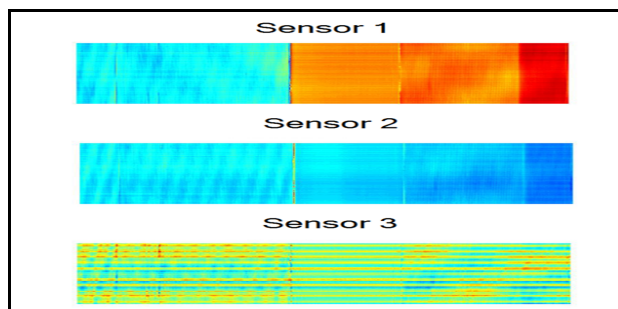

Project Number	SCG1240026
Start Date	2012
End Date	2017
Estimated Total Project Cost (SCG)	\$95,000
Co-funder	PRCI Members
Co-funding Amount	\$683,000

System Inspection & Monitoring - Pipeline Inspection Technologies

Unmanned Aerial System RD&D

Demonstrate Unmanned Aerial Systems or drones for pipeline and facility leak and safety inspections.

Project Description / Objectives

Demonstrate the use of Unmanned Aerial Systems (UAS) for pipeline and facility methane leak and safety inspections in rural or challenging environments. Coordinate and work together with Transmission Operations group to select and fly initial inspection sights. Secure a FAA Section 333 Exemption for flying UAS in our service territory. Acquire an UAS platform and test it with advanced inspection technologies. Develop internal standards for operational safety and reliability. Target dates for completion of initial demonstrations and evaluation of business model was year end 2016. The testing identified the need for further testing of capabilities and system upgrades to be completed in 2017.

Drivers / Benefits

Compliance or emergency inspection of company facilities in difficult to reach locations can be performed efficiently and safely with the use of an UAS/Drone compared to helicopter, fixed wing platforms or human ROW inspections. The UAS/Drone can be equipped with high definition camera, GPS, and methane leak detection technologies in a light weight and compact footprint. Through regular inspections enhance public safety of pipeline system.

Results / Status

UAS hands-on flight training was completed. The Pergam laser methane detection equipment successfully detected a buried flange leak. The Pergam equipment is still being perfected to improve the cumbersome task of processing data, and to improve pin pointing capabilities with real time data pilot. Mapping of three compressor station assets was completed in 2016, but system accuracy did not meet the SoCalGas GIS requirements for integration. A system upgrade with improved accuracy for survey and mapping missions was released at the end of the year. Testing will continue in 2017.



Project Number	SCG15400161
Start Date	2015
End Date	2018
Estimated Total Project Cost (SCG)	\$250,000

Appendix C – Low Carbon Resources

USC Carbon Capture Membrane Research

This proposal describes a number of key “proof-of-concept” for CO₂ capture and methanation.

Project Description / Objectives

USC will investigate the newly developed high-temperature, affinity type (HAFT) CO₂-selective membranes. These membranes are made from layer double hydroxides (LDH), which have unique affinity to CO₂, and have shown reversible CO₂ transport in high-temperature environments, specifically in separating CO₂ from CO₂/N₂ mixtures – a model binary gas mixture of relevance to flue-gas Applications.

Drivers / Benefits

A potential solution to the growing problem of energy storage of over generated renewable power is methane storage by utilizing flue gas CO₂. This process has the dual effect of reducing greenhouse gas as well by reusing the carbon source. If the H₂ needed for methanation is produced via electrolysis using a renewable source of energy (e.g., solar) then the overall system efficiency could surpass many other technologies currently available.

Results / Status

Characterization and testing of membranes and catalysts is underway.

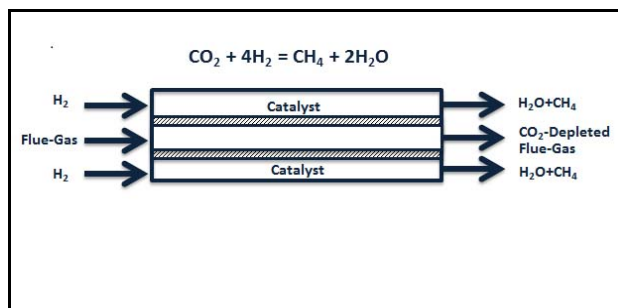

Project Number	SCG1510022
Start Date	2015
End Date	2016
Estimated Total Project Cost (SCG)	\$146,419

Renewable Natural Gas & Renewable Hydrogen - Methane Reforming

JPL Nonthermal Plasma for Methane to Hydrogen Research

Development of a catalytic nonthermal plasma (CNTP) system to efficiently produce hydrogen from CH₄.

Project Description / Objectives

In order to develop a means by which hydrogen produced from natural gas can be supplied for the anticipated availability of fuel cell vehicles within the next few years JPL is developing a novel catalytic nonthermal plasma (CNTP) technology to efficiently produce hydrogen on an as-needed basis for application to distributed hydrogen suppliers and consumers. The anticipated advantages associated with a catalytic nonthermal plasma reactor are compact size, rapid start, and wide turndown with high efficiency. Additionally, this technology is expected to be applicable to the conversion hydrogen and carbon dioxide to methane and thus create an economical "power-to-gas" pathway for storing surplus renewable electrical power.

The end product of this RD&D project will be a catalytic nonthermal plasma reformer will be designed, built and tested to demonstrate commercial feasibility. Detailed designs and operating procedures that will be provided for transfer to potential commercial producers of the reformer system.

Drivers / Benefits

The development of a catalytic nonthermal plasma methane reformer will enable a more rapid development of ultra-clean fuel cell vehicles by supporting the build-out of hydrogen fueling infrastructure. When parked, fuel cell vehicles also have the potential to provide distributed electric power, heat and water to residences and small businesses. Thus, this project will generate economic benefits, energy savings and reductions in greenhouse gas emissions.

Results / Status

Developed a custom power supply capable of generating higher plasma power for the scaled-up reactor
Original audio amplifier (EP4000) did not have enough power for the scaled-up CNTP reactor
A custom converter (DC to AC) was designed/fabricated and demonstrated with commercial DC power supply units.[Agilent 6030, 6035; N8742A (600V, 5.5A)]
Successfully demonstrated generation of plasma with 500 W power supply
Developed and evaluated the performance of the five catalyst systems
Developed a Brass-board Reactor Concept (5kg H₂/day)

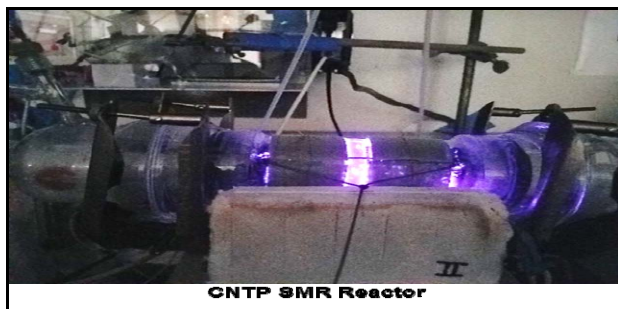

Project Number	SCG1350009
Start Date	2013
End Date	2016
Estimated Total Project Cost (SCG)	\$1,299,481

Renewable Natural Gas & Renewable Hydrogen - Methane Reforming

Solar Thermal Platform - Compact Linear Fresnel Reflector

Demonstrating a low-cost reflector system for solar-thermal recovery and other uses.

Project Description / Objectives

The purpose of this project is to develop a low-cost solar thermal platform that can "bolt" onto and boosts the output of fossil-fired systems such as power plants, boilers and adsorption chillers.

Combined Power's platform, Hyperlight™, is a unique, low-cost, reflector system for a Compact Linear Fresnel Reflector (CLFR), with a linear receiver and single-axis tracking. The most important cost driver of a CLFR plant is the solar reflector field (up to 45% of total cost). Combined Power's key innovation is the use of covered water as a structural material, providing a perfectly level foundation that enables the use of lightweight, inexpensive commodity materials, including extruded plastic.

The system can simultaneously serve other purposes such as:

- heat exchanger that enables non-evaporative (dry) cooling of the power-generator block
- solar still for water purification
- photobioreactor for algae cultivation and CO2 recycling

Drivers / Benefits

Benefits to ratepayers include:

- # Reduced greenhouse-gas production
- # Sustainable energy generation
- # Reduced energy costs through low-cost solar thermal technology.
- # Water conservation

This technology may lead to new crops, such as microalgae that can be cultivated inside the CP tubes.

Results / Status

In 2012, groundbreaking was achieved at the demonstration site at San Diego State University's Brawley campus.

The technology was improved by placing the mirror on the outside of the tube -- the tubes are now "D-shaped" rather than round. In addition, a design was developed to configure the system around a central receiving tower.

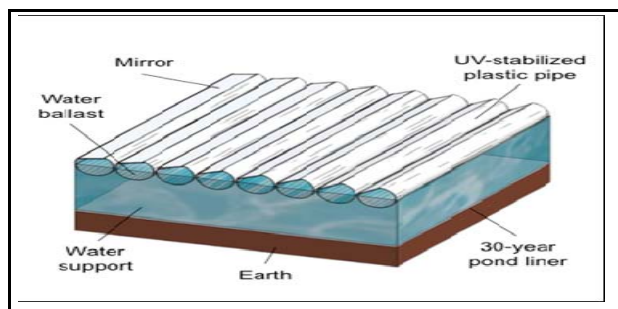

Project Number	SCG1150005
Start Date	2011
End Date	2015
Estimated Total Project Cost (SCG)	\$1,000,000
Co-funder	California Energy Commission (CEC)
Co-funding Amount	\$1,000,000

UCI Power-to-Gas Electrolyzer Demonstration

Use UCI's microgrid to generate clean H₂, blend H₂ with NG, feed blended gas to NGCC power plant.

Project Description / Objectives

The National Fuel Cell Research Center (NFCRC) of the University of California, Irvine (UCI) has extensive expertise, experimental facilities, and theoretical analysis tools for evaluating renewable power, electrolysis, fuel cells, and other advanced and alternative energy technologies that are directly applicable to the Power-to-Gas (P2G) concept. With SoCalGas support and collaboration, UCI will apply NFCRC personnel time, fuel cell and electrolyzer systems expertise, and previously developed experimental testing equipment and theoretical analysis techniques to a joint project concerning the Power-to-Gas concept.

Drivers / Benefits

Power-to-Gas (P2G) solves issues of intermittency on supply/demand mismatch that limit deployment of wind and solar power. By using otherwise curtailed renewable power to produce gaseous fuel, zero carbon fuels can be produced for lower cost than traditional renewable fuels. P2G can also serve to stabilize the electric grid by serving as a dispatchable load and providing valuable ancillary service.

Results / Status

- Investigated lab-scale H₂ production dynamics by direct-DC & AC PV electrolysis
- H₂ and H₂/natural gas mixtures were injected into customer-side natural gas system for leakage assessment
- Evaluated a customer-side leakage mitigation strategy
- Completed dynamic simulation and evaluation of Power-to-Gas (P2G) impacts on the electric grid and the UCI microgrid
- Accomplished full-scale hydrogen production & injection into an existing 400 psi natural gas pipeline that feeds the UCI NGCC Power Plant
- Simulated impacts of hydrogen (embrittlement, fatigue) on pipeline materials



Project Number	168311183
Start Date	2016
End Date	2016
Estimated Total Project Cost (SCG)	\$915,125

UCI Power-to-Gas Grid Scale Model Development

Investigate and compare the use of P2G as a form of energy storage and a dispatchable load.

Project Description / Objectives

The focus of this study is to investigate the potential benefits of using Power-to-Gas (P2G) systems as a form of energy storage and as a dispatchable load in regards to impacts on the integrated electricity system. Both technical and economic factors must be considered.

To accomplish the assessment, models that represent the operation of P2G systems as either energy storage or dispatchable load will be integrated with and simulated on the Holistic Grid Resource Integration and Deployment (HiGRID) model for the state of California. Three key scenarios will be examined:

1. Using P2G and electrical energy storage (P2G2P)
2. Using P2G as a dispatchable load to produce hydrogen for fuel cell vehicles (FCEV)
3. Using P2G as a dispatchable load for the production of renewable natural gas (RNG)

Drivers / Benefits

This modeling will help policy makers understanding the economic and environmental impacts of large deployment of P2G on the grid. Simulations will help guide investors to the most promising technologies with the optimal benefits for the grid.

Results / Status

- Models were successfully developed and integrated, creating a valuable tool to evaluate P2G deployment in California.
- Initial modeling efforts focused on comparing the Levelized Cost of Returned Energy (LCORE) for various storage technologies and pathways. The results show that certain P2G pathways can be cost competitive with battery technology.

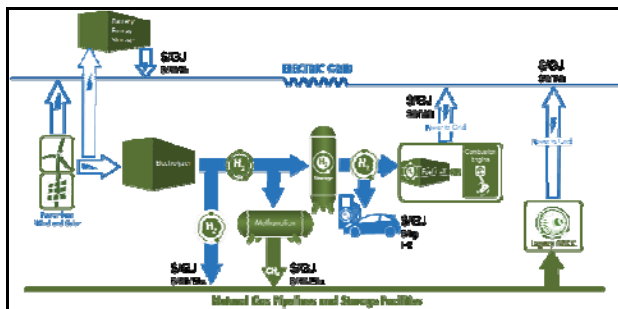

Project Number	168311186
Start Date	2016
End Date	2016
Estimated Total Project Cost (SCG)	\$250,000

Solar Thermal And Thermal Energy Exchange - Solar Concentrators & Receivers

CEC Hyperlight Genifuel Concentrated Solar Hydrothermal Processing Demonstration

Dairy waste to RNG by integrating concentrated solar power with hydrothermal processing technology

Project Description / Objectives

The purpose of this project is to develop and demonstrate an innovative, bench-scale waste-to-energy system that converts dairy manure into low carbon intensity, high-quality renewable natural gas (RNG) suitable for energy applications including distributed electricity production via internal combustion engines, microturbines and fuel cells or larger, centralized electricity production via combined cycle power plants.

Drivers / Benefits

Production of RNG is essential to meet the GHG emissions goals adopted in California. This project will develop a new, highly productive process for extracting renewable energy from wet biomass.

Results / Status

Optimized CSP receiver design to achieve 390° C
 Filed patent application receiver design optimization algorithm
 Updated HTP system design. Doubling the project output might be possible and will be considered.
 Hyperlight won an additional DOE award for work that will benefit this project. This will culminate in a 1 acre pilot CSP field in a hybrid configuration at an existing geothermal power plant. The budget includes \$1.5 mm from DOE and \$750,000 from CEC.
 Passed CEC year-1 CEC project review. On schedule overall



Project Number	168311182
Start Date	2016
End Date	2018
Estimated Total Project Cost (SCG)	\$300,000
Co-funder	CEC
Co-funding Amount	\$1,500,000

Solar Thermal And Thermal Energy Exchange - Solar Concentrators & Receivers

NREL Power-to-Gas Biomethanation Demonstration

Design, build and operate a small-scale P2G system using equipment available at NREL and ESIF.

Project Description / Objectives

The proposed approach is for the SoCalGas team to work directly with NREL, co-fund NREL RD&D activities and use the NREL's knowledge of solar power sources and related technologies (e.g., PVr, electrolyzers, fuel cells, and bioreactors) to develop a power-to-gas energy storage dynamic simulation model incorporating performance parameters for these elements (e.g., start-up time, shut down time, transients from solar). Concurrently, the NREL team will design, build and operate a small-scale physical power-to-gas system using equipment and other resources available at NREL to test the system performance. This information will be used to calibrate the steady state and dynamic simulation models. Accompanying financial analyses will be developed to assess the benefits of the system, run scenario analyses, and identify future development pathways that will have the greatest impact on the system's financial performance. The work at NREL will lay the foundation for a 60 kW – 240 kW commercial pilot demonstration in Southern California.

Drivers / Benefits

Quantified Benefits:

- Lower LCOE for solar and wind power generation.
- Improved effective capacity factor baseload solar and wind generation.
- Revenue from ancillary electric grid services and oxygen sales

Results / Status

The Task 1 dynamic model of the power-to-gas. The model has been integrated in PLEXOS software. The Task 2 biomethanation system has been designed and fabrication is underway. System completion is expected by June 1 2017, and testing will begin shortly thereafter. The test plan has been developed.

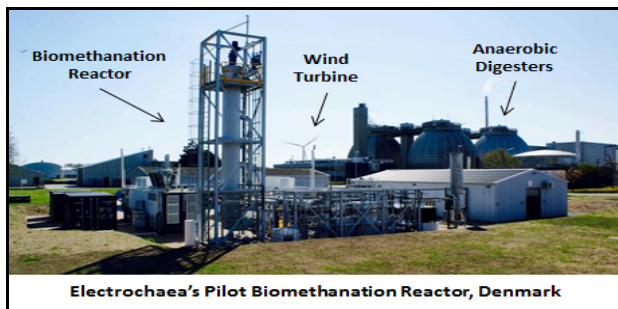

Project Number	SCG1410036
Start Date	2014
End Date	2016
Estimated Total Project Cost (SCG)	\$900,000
Co-funder	National Renewable Energy Laboratory
Co-funding Amount	\$450

Solar Thermal And Thermal Energy Exchange - Solar Concentrators & Receivers

PNNL Solar Microchannel Steam Methane Reformer Prototype Testing

Field testing of a prototype solar SMR system at Brawley test site.

Project Description / Objectives

The purpose of this project is to aggressively support the near-term commercialization of a new technology platform – based on the integration of solar concentrators and micro/micro-channel process technology (MMPT). Specific objectives include advancing Solar Thermochemical Advanced Reactor System (STARS or Dish-STARS), to Technology Readiness Level 8 (TRL 8) for two near-term California applications: 1) Renewable hydrogen production for fuel cell vehicle filling stations and 2) Renewable hydrogen production for refineries. Because Dish-STARS efficiently applies concentrated solar energy to perform endothermic chemical processes, successful commercialization of Dish-STARSTM can help enable California and the USA to achieve greenhouse gas emission reduction goals, including the California Low Carbon Fuel Standard and California’s 2030 Climate Goals

The co-production of methanol with hydrogen as a means of eliminating CO2 emissions is also targeted. While Dish-STARSTM is potentially valuable for several applications, achieving a high TRL version as the “Minimum Viable Product” for Dish-STARSTM allows near term commercial pilot demonstrations and broad deployment.

Drivers / Benefits

This project will establish and advance a highly efficient method of converting natural gas (from fossil and/or renewable methane sources) to hydrogen and other fuels/chemicals, with lower net CO2 emissions than typically occur with other hydrogen production systems. The carbon intensity goals for the hydrogen product, for hydrogen production only and for the co-production of hydrogen, are respectively approximately 60% and 15% of the life-cycle carbon intensities of hydrogen when produced from fossil natural gas using conventional technology.

Results / Status

Designed and fabricated the TRL 6 reactor has been completed. On-sun testing at SDSU Brawley was conducted in 2016. A final report on the TRL 6 system was submitted and accepted by the DOE. DOE has agreed to fund additional testing and investigation of carbon utilization via methanol and plastics production.



Project Number	168311189
Start Date	2015
End Date	2018
Estimated Total Project Cost (SCG)	\$850,000

Solar Thermal And Thermal Energy Exchange - Solar Concentrators & Receivers

Solar Thermal Water Splitting

Renewable hydrogen and methane production using state-of-the-art high-flux solar concentrators.

Project Description / Objectives

The purpose of this project is to develop a viable solar high-temperature thermo-chemical water-splitting cycle that not only uses solar flux for heating but also includes a “solar boost” from photon absorption in the chemical process. The project will also consider combined electro-chemical and thermochemical cycles that could potentially meet DOE’s solar hydrogen production efficiency and cost performance goals. Secondary goals are to build and operate a pilot-scale solar hydrogen production system to demonstrate practical implementation of the selected cycle, and to verify the cost-effectiveness of this approach for commercial production of H₂ from water. Specific objectives include:

- Determine thermo-chemical and economic characteristics of potential solar-boosted/solar assisted water-splitting cycles.
- Select a cycle that has the best potential for cost-effective production of hydrogen from water.
- Demonstrate technical feasibility of the selected cycle using solar input in a bench-scale reactor.
- Demonstrate pre-commercial feasibility through economic analysis of the selected cycle and demonstration of a fully-integrated pilot-scale solar hydrogen production system.

Drivers / Benefits

This technology supports California’s policy goals of accelerating deployment of renewable resources and significantly reducing greenhouse gas (GHG) emissions. The systems developed under this contract have the potential to provide a production pathway for renewable hydrogen or methane that is not dependent upon organic feedstock .

Results / Status

Several studies were performed using the Aspen Plus model to improve efficiency such as investigating the effect of electrolyte concentration in the electrolyzer on operating conditions and efficiency of the plant. Several approaches to improving the electrophoretic deposition of both cobalt ferrite and platinum cobalt nanoparticles were performed as well. Screening of electrocatalysts continues in an effort to find materials that can reduce the anodic overpotential for sulfite oxidation.



Project Number	SCG13500528
Start Date	2012
End Date	2015
Estimated Total Project Cost (SCG)	\$538,000

Solar Thermal And Thermal Energy Exchange - Solar Concentrators & Receivers

UCLA ARPA-E Thermal Energy Storage With Supercritical Fluids

This project will create a commercialization plan for UCLA's new thermal energy storage technology.

Project Description / Objectives

This project is a response to ARPA-E's call for "transformation" technologies which can cause the thermal energy-based industry to shift the way energy is captured and utilized. The UCLA thermal energy storage (TES) system uses a novel and low-cost approach that is designed to operate over a wide range of temperatures using elemental sulfur as the storage media.

Drivers / Benefits

UCLA will develop the technology with the assistance of CPP, while SCG and Hyperlight will provide assistance and guidance with the relevant applications and tech-to-market efforts. The Tech-to-Market identifies the potential markets and determines the appropriate pathways to develop and demonstrate the technology for these markets. The storage concept is sufficiently generic and potentially cost-effective that it can be used for a broad range of applications.

Results / Status

Cost and system analyses performed in the course of this project have shown that the high performance and low cost of UCLA's thermal storage technology provides a cost-effective solution for a wide range of applications. The technology was demonstrated to be viable for dispatchable grid-scale concentrated solar power (CSP) and a number of nearer term applications such as natural gas-powered combined heat and power (CHP) and absorption cooling systems.

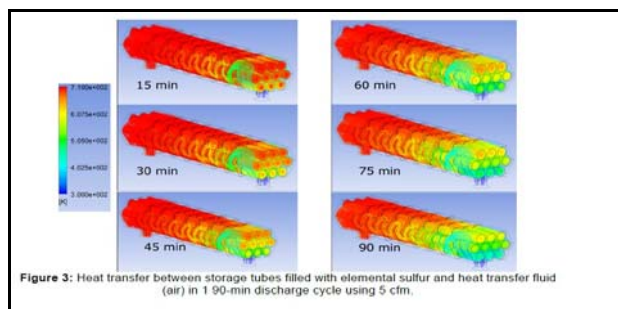

Project Number	SCG15500531
Start Date	2015
End Date	2016
Estimated Total Project Cost (SCG)	\$125,000
Co-funder	DoE / ARP Ae
Co-funding Amount	\$500,000

Solar Thermal And Thermal Energy Exchange - Solar Concentrators & Receivers

UCLA Liquid Sulfur Thermal Energy Storage Research

The 30-kWh pilot-scale demonstration of the sulfur-based thermal energy storage in Brawley, CA.

Project Description / Objectives

The award is for a 3-year applied research effort that is complementary to the ARPA-E commercialization effort. This CEC/SoCalGas funded effort must be performed in parallel to understand this new approach to thermal energy storage and provide confidence in the 20- to 30-year performance of the technology. To achieve this objective, this effort will culminate in an on-site technology demonstration at the Hyperlight Energy facility in Brawley, CA. The SoCalGas cost-share funds are necessary to support the research and development of the technology and to support the field demonstration.

Drivers / Benefits

The proposed project is an enabling technology that increases the reliability and dispatchability of utility-scale CSP plants by providing cost-effective power generation ability during non-solar hours, by reducing the cost of TES for CSP, and consequently LCOE for the consumer. The proposed project eliminates molten salt which is an expensive thermal storage fluid, with cost volatility due to its use as a fertilizer commodity. The proposed project reduces the cost of TES to \$15/kWh leading to decrease in the share of TES in LCOE from 3.0 ¢/kWh to 0.4 ¢/kWh.

Results / Status

R&D progress.

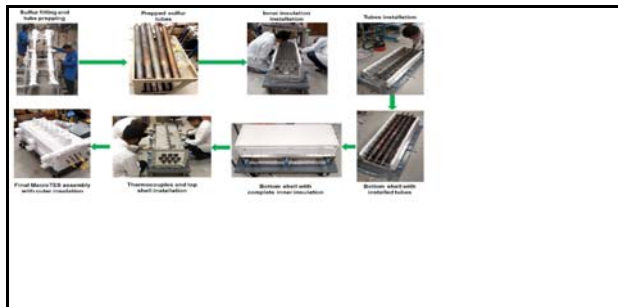

Project Number	SCG15500532
Start Date	2015
End Date	2018
Estimated Total Project Cost (SCG)	\$300,000
Co-funder	California Energy Commission
Co-funding Amount	\$1,497,024

Appendix D – Program Wide Partnership

Program Wide Partnership - Program Wide Partnership

Northeast Gas Association Collaborative Research

Participation in research projects with the Northeast Gas Association's NYSEARCH RD&D Consortium.

Project Description / Objectives

SoCalGas participates in and co-funds various gas operations research projects through Northeast Gas Association's NYSEARCH RD&D organization. NYSEARCH is a voluntary research collaborative of 20 gas transmission and distribution companies, and projects are managed and administered by the NYSEARCH staff. NGA membership dues in 2015 were \$60,000, excluding project funding commitments which are made separately.

NGA is a regional trade association that focuses on education and training, technology research and development, operations, planning, and increasing public awareness of natural gas in the Northeast USA. NGA was established on January 1, 2003. Its predecessor organizations were The New England Gas Association (founded in 1926) and the New York Gas Group (founded in 1973).

Drivers / Benefits

NYSEARCH has been active in developing technology and solutions in gas operations, including transmission and distribution pipeline integrity, diversity of gas supply, and environmental compliance and greenhouse gas emissions. Participation in NGA/NYSEARCH helps to leverage RD&D costs and provides access to valuable industry knowledge and experience. Utility ratepayers benefit from enhanced safety, environmental, and efficiency benefits.

Results / Status

SCG is co-funding projects in the following areas: Pipeline Integrity and Inspection, Gas Quality, and Leak Detection and Quantification. A number of key projects have received co-funding from PHSMA, including the development crack sensors for hard to pig/inspect pipelines. NYSEARCH is also involved in advancing methane leak detection technologies and validating vendor's specifications on leak quantification levels. Summaries of projects of interest can be found individually in the Annual Report.

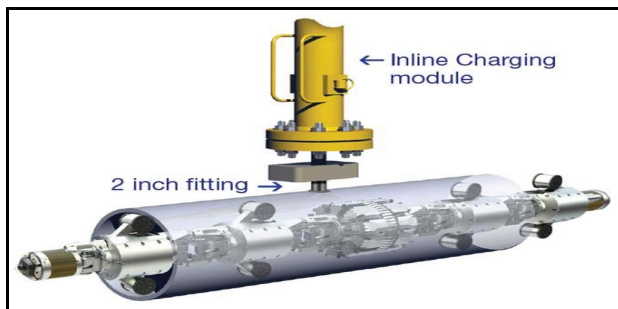

Project Number	SCG05310602
Start Date	2016
End Date	2016
Estimated Total Project Cost (SCG)	\$204,900
Co-funder	NYSEARCH
Co-funding Amount	\$772,000

Program Wide Partnership - Program Wide Partnership

Operations Technology Development Program

Develop and evaluate gas operations technologies through a collaborative funding program.

Project Description / Objectives

The objective of the Operations Technology Development (OTD) program is to address a wide range of technology issues relating to gas operations and its infrastructure through the collaboration and funding support from other member companies.

Twenty-four OTD member companies pool their resources and leverage available funding to ensure that complex tasks are becoming easier to accomplish, expensive activities are becoming less costly, and risk is becoming more manageable.

Drivers / Benefits

OTD projects are designed to; enhance system/public safety, improve operating efficiencies, maintain system reliability and integrity, reduce environmental impact, and comply with latest Federal and State regulations.

Results / Status

In 2016, 18 new projects were initiated and 8 projects were completed. Examples of new projects include; AC Earth Faults, Center for Methane Research, Odorant Dispersion, Prevent Gas Blowdown to Atmosphere, Gas Imaging Technologies, and completed projects include; Field Measurement of Leak Flow Rates - Phase 1, Cathodic Disbondment Detector - Phase 1, and Qualifying PE Joining Procedure - Phase 1.



Project Number	SCG07310401
Start Date	2016
End Date	2016
Estimated Total Project Cost (SCG)	\$750,000
Co-funder	OTD Members
Co-funding Amount	\$4,940,298

Program Wide Partnership - Program Wide Partnership

PRCI Collaborative Research

Member supported research on transmission, storage, measurement, and compression technologies.

Project Description / Objectives

Pipeline Research Council International (PRCI) develops products, designs, and standards that increase efficiency, reliability, and safety of transmission and storage systems. Established in 1952, PRCI manages and administers research projects carried out by third party experts and technical organizations. Over 40 domestic and international companies are PRCI members, including some of the largest multinational energy companies.

Drivers / Benefits

Company is engaged in and funds at one time or other forty research projects in the following committees: Corrosion, Design, Materials, & Construction, Integrity & Maintenance, Measurement, Compressor & Pump Stations, and Underground Storage. Company representatives for each committee participate in meetings and discussions to monitor progress and developments on individual projects. Research projects making significant progress and results are described separately in this report. The photo depicts a pipeline with wrinkle bends that will undergo non-destructive performance testing.

Results / Status

Through co-funding and collaboration, the number of projects that can be supported is significantly larger than otherwise possible. Participation in committee meetings and project review calls provides access to industry leaders with a very high level of expertise and experience. As a result, the information and knowledge gained is very helpful to introducing state-of-the-art standards and technology to company operations. Also, PRCI has built the Technology Development Center near Houston, where research and testing of salvaged pipelines and materials can be performed.



Project Number	SCG11700104
Start Date	2016
End Date	2016
Estimated Total Project Cost (SCG)	\$220,450
Co-funder	PRCI Members
Co-funding Amount	\$1,280,000

Program Wide Partnership - Program Wide Partnership

Sustaining Membership Program (SMP)

Consortium of 10 utilities that combine funds to provide financial support for RDD.

Project Description / Objectives

The objective of the Sustaining Membership Program (SMP) is to build the natural gas technology base for member companies through the development of new ideas and innovative concepts beyond the near term horizon. The SMP focus is on cutting-edge technology and its applicability to deliver new products, processes and solutions for the natural gas industry. It is the intention of the SMP to develop the technology up through “proof of concept”, at which point the most promising technologies are continued through short to mid-term RD&D programs such as Operations, and Technology Development and Utilization.

Drivers / Benefits

Ratepayers benefit from the development of new, advanced gas-fired technologies and end use equipment and also benefit from the significant leveraging of funds from the participating membership. The natural gas industry needs to ensure natural gas:

- Is perceived by stakeholders as an energy source that is safely and cost effectively delivered to a broad range of end users.
- Has a clearly differentiated role from electricity in end use applications.
- Is compatible with society’s demands for expanded use of renewable and sustainable energy.

Results / Status

For 2016, funding was provided for the following projects:

- * Carnot Compression - Advanced High Efficiency Compression, Phase 2
- * Vehicle Full Fills and Communication
- * Evaluation of Boostheat and Climate Well Thermodynamic Cycles for Space/Water Heating
- * Evaluation of Self-Powered Appliance Technologies
- * Novel Gas Heat Transfer, Storage, and On-Demand Recovery Technology



Project Number	SCG11700103
Start Date	2016
End Date	2016
Estimated Total Project Cost (SCG)	\$100,000
Co-funder	SMP
Co-funding Amount	\$1,200,000

Program Wide Partnership - Program Wide Partnership

Utilization Technology Development (UTD) Program

SCG and 16 other leading gas utilities jointly fund gas research conducted by GTI.

Project Description / Objectives

UTD is a not-for-profit corporation led by 17 members who serve over 24 million natural gas consumers in 25 states, Canada, and the European Union formed to conduct near term applied research and to develop, test and deploy energy efficient, environmentally friendly end use technologies. The objectives of UTD are to: direct the development of end use technologies where stakeholder needs are not adequately met by existing technology and to ensure market success via deployment and commercialization of the developed technologies. UTD conducts its RD&D efforts in a stage-gate process, working in collaboration with gas industry partners, federal and state government agencies, industrial and manufacturing partners, and other stakeholders.

Drivers / Benefits

Natural gas is well positioned in many residential, commercial, and industrial markets—while facing strong competition from electricity in the building sector. The industrial sector is primarily driven by dimensions tied to competitiveness (which includes reducing energy costs) and productivity. Power generation and transportation sectors represent growth areas for natural gas with major societal benefits. Energy efficiency programs are a major component of many gas distribution companies and their relationship with customers. UTD projects offer benefits to all major market segments.

Results / Status

UTD has six core RD&D working groups: Water Heating, Space Conditioning, Foodservice, Industrial Solutions, Power Generation/CHP, and Transportation. In 2016, UTD managed a multi-million-dollar program with more than 60 active projects spanning water heating, space conditioning, commercial foodservice (CFS), industrial processes, power generation/CHP, and transportation. SoCalGas funded approximately 23 UTD projects in 2016.

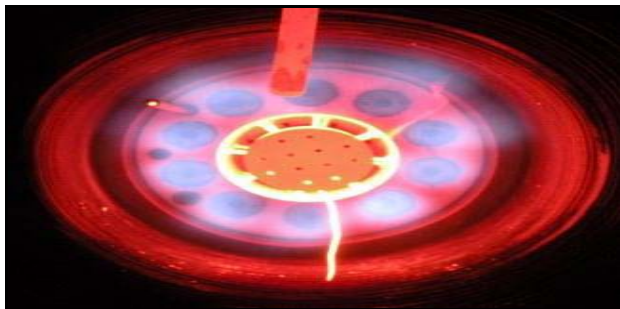

Project Number	SCG157001146
Start Date	2016
End Date	2016
Estimated Total Project Cost (SCG)	\$750,000
Co-funder	UTD
Co-funding Amount	\$3,103,700



Company Operations Standard Gas Standard Gas Operations

Leakage Classification and Mitigation Schedules	SCG:	223.0125
---	------	----------

PURPOSE To establish guidelines and requirements for assessing the degree of hazard and classification of leaks or leak indications found on Company piping system, and actions required to provide for public safety and repair of the leak.

1. POLICY AND SCOPE

- 1.1. Leak indications on Company facilities are classified by trained and qualified employees according to location, spread, concentration of gas, possibility for accumulation of gas, possible sources of ignition, potential migration and imminence of hazard to people or property. Classifications of leaks or leak indications are based on a relative degree of hazard and examples listed are intended only as a guide. The judgment of the person evaluating the leak or leak indication, after consideration of all factors involved, is the primary criterion for classification and mitigation.
- 1.2. Hazardous indications of underground leaks are reported and action is taken according to this Gas Standard until the hazard has been eliminated and the leak has been either temporarily or permanently repaired; or until it is determined that the leak is from a source other than the Company piping system. Refer to [GS 184.0220, Field Gas](#), for handling of field gas.
- 1.3. Classification of a leak or leak indication establishes a maximum time limit from date of detection for taking corrective action. Dates may be set for action prior to the maximum time limit for safety, public relations reasons, or other special considerations by trained and qualified employees.

Note: In a situation where a leak requires an earlier scheduled repair, the employee must contact supervision and share all pertinent information by the end of that working day. The Supervisor must take the necessary actions to bring these situations to the attention of the individual responsible for scheduling leakage repair to expedite the leak repair.

Note: Although a repair of a classified leak may be expedited for a variety of reasons, the original classification of the leak shall not be changed.

- 1.4. In the event that leakage is discovered in the vicinity of a pipeline operating at greater than 60 PSIG, refer to [GS 183.06, Reports of Safety-Related Pipeline Conditions](#), to determine any additional reporting requirements and actions.

Note: Storage piping solely under the jurisdiction of the Department of Oil, Gas, and Geothermal Resources (DOGGR) is not subject to these policies. DOT-defined Distribution piping includes the meter set assembly (MSA) up to the inlet of the Customer's piping.

Leakage Classification and Mitigation Schedules	SCG:	223.0125
--	-------------	-----------------

2. RESPONSIBILITIES AND QUALIFICATIONS

- 2.1. **Pipeline Integrity** is responsible for the specific guidelines as it relates to regulatory requirements and ensuring compliance with the Company's Integrity Management Plan.
- 2.2. **Gas Operations Staff and Technical Service** is responsible for the process of duties performed and the equipment utilized for assessing the degree of hazard and classification of leaks or leak indications found.
- 2.3. **Distribution, Transmission, and Storage** qualified field employees are required to code all leak indications in the vicinity of buried DOT Transmission and Distribution defined Company pipelines and facilities in accordance with this gas standard.
- 2.4. **Distribution, Transmission, Storage, M&R and Customer Services** qualified field employees are required to classify all leaks identified on above ground (not buried) DOT Transmission and Distribution defined Company pipelines and facilities in accordance with this gas standard.
- 2.5. Assigning leakage classifications must be performed by trained and qualified individuals refer to [GS 167.0100](#), *Operator Qualification Program*.
- 2.6. When **any Company department** detects a non-hazardous leak or leak indications on a facility operated by another Company department, notification to that department shall be made the same day or within one business day

Note: A company employee finding hazardous leak indications must remain at the location performing activities to their ability and training in an effort to keep themselves, the public and the area safe until the responding employee(s) to correct the leak has arrived.

- 2.7. **Gas Operations Training** is responsible for ensuring the equipment and facilities used by an Operator for training and qualification of employees must be identical, or very similar in operation to the equipment and facilities which the employee will use, or on which the employee will perform the covered task per GO112-F 143.4.

3. DEFINITIONS

- 3.1. **Explosive Limits for Natural Gas** - 4.5% to 15% Gas Volume (gas / air mixture).
 - 3.1.1. **Lower Explosive Limit (LEL)** - 4.5% Gas Volume (100% of the LEL) indicate the lower explosive range of gas.
- 3.2. **Repair** - As it relates to this Gas Standard, is defined as a permanent modification to the gas facilities that eliminates the natural gas leak.

Leakage Classification and Mitigation Schedules	SCG:	223.0125
--	-------------	-----------------

- 3.3. **Temporary Repair** - As it relates to this Gas Standard is defined as a temporary modification to the gas facilities that eliminates the natural gas leak and will require a return visit to complete a permanent repair.

Note: Drilling and purging bar holes (sometimes is referred to as aeration) is not considered a temporary repair. This process is utilized for verifying and centering below ground leak indications. Refer to [GS 184.0245](#), *Leak Investigation – Distribution* for drilling and purging of bar holes.

- 3.4. **Remote location** - As it relates to this Gas Standard is defined as a company facility that is located a sufficient distance from any building or structure intended for human occupancy, roadways, and walkways (excluding roadways and walkways within Company facilities that are restricted from public access)

- 3.5. **Leak** – A leak is defined as an unintentional escape of gas from a gas facility.

- 3.6. **Leakage Coding** – As it relates to GO 112 F within this document – A “Grade 1” leak is referred to as a Code 1 leak, a “Grade 2” leak is referred to as a Code 2 leak, and a “Grade 3” leak is referred to as a Code 3 leak.

3.6.1. Below ground leak indications are coded.

3.6.2. Above ground leak indications are classified.

- 3.7. **Leak Concentration** - The amount of leakage registered on the leak detection instrument.

- 3.8. **MSA Leaks** –Leaks on the above ground piping, downstream of the riser and including the service valve.

Note: Service valve leaks or service valve replacements that require modification to the riser shall be classified as a riser leak, such as but not limited to, cut and thread repair due to corrosion.

- 3.9. **Riser Leaks** – Leaks on the above ground portion of service piping between the ground and service valve.

Note: Any leak that can be resolved by service valve replacement or adjustment that does not require modification to the riser shall be classified as a MSA leak. Service valve leaks repaired by lubrication, tightening or adjustment shall be considered part of the MSA.

Leakage Classification and Mitigation Schedules	SCG:	223.0125
--	-------------	-----------------

- 3.10. **Buried Service Leaks** – Leaks on service piping below ground, including the vertical buried portion of the service pipe. These leaks should be coded 1, 2 or 3.

Note: Below ground leaks are never classified Hazardous, Non-Hazardous or Minor.

3.11. **BELOW GROUND LEAK INDICATIONS**

- 3.11.1. **CODE 1 LEAK INDICATION** - a leak that represents an existing or probable hazard to persons or property and requiring prompt action, immediate repair or continuous action until the conditions are no longer hazardous.

Note: Temporary repairs may be made and documented to eliminate the immediate hazard however; permanent repairs must be scheduled and completed per section 4.1.1 of this Gas Standard.

- 3.11.1.1. Examples of Code 1 leak indications include, but are not limited to:

3.11.1.1.1. Blowing gas that can be seen, heard, or felt.

3.11.1.1.2. Escaping gas that has ignited unintentionally.

3.11.1.1.3. Any indication of gas which has migrated into or under a building or tunnel; or at the outside wall of a building, or where gas could potentially migrate to an outside wall of a building.

3.11.1.1.4. A leak with gas indications of 3% gas/air mixture or greater in substructures that people can enter.

3.11.1.1.5. A leak with gas indications of 80% LEL (3.6% gas / air mixture) or greater in an enclosed space.

3.11.1.1.6. A leak with gas indications of 3% gas/air mixture or greater in enclosures containing electrical equipment.

3.11.1.1.7. A leak with gas indications of 80% LEL (3.6% gas / air mixture) or greater in small substructures not associated with gas facilities where the gas could potentially migrate to the outside wall of a building.

3.11.2. **CODE 2 LEAK INDICATION** - a leak that is recognized as being not-hazardous at the time of detection, but justifies scheduled repair based on the potential for creating a future hazard.

Note: Permanent repairs must be scheduled and completed per section 4.1.2 of this Gas Standard.

3.11.2.1. Examples of Code 2 leak indications include, but are not limited to:

3.11.2.1.1. A leak with gas indications of less than 80% LEL (3.6% gas / air mixture) near buildings or structures within 5 feet if unpaved that does not qualify as a Code 1 leak and where it is unlikely gas could potentially migrate to the outside wall of a building.

3.11.2.1.2. Any reading of 40% LEL to 80% LEL (1.8% to 3.6% gas / air mixture) under a sidewalk in a wall-to-wall or continuously paved area that does not qualify as a Code 1 leak and where it is unlikely gas could potentially migrate to the outside wall of a building.

3.11.2.1.3. Any reading of 100% LEL (4.5% gas / air mixture) or less under a street in a wall-to-wall paved area that does not qualify as a Code 1 leak and where it is unlikely gas could potentially migrate to the outside wall of a building.

3.11.2.1.4. A leak with gas indications of less than 3% gas/air mixture in substructures that people can enter.

3.11.2.1.5. A leak with gas indications of less than 80% LEL (3.6% gas / air mixture) in an enclosed space.

3.11.2.1.6. A leak with gas indications of less than 3% gas/air mixture in enclosures containing electrical equipment.

3.11.2.1.7. A leak with gas indications of less than 80% LEL (3.6% gas / air mixture) in small substructures not associated with gas facilities and where it is unlikely gas could potentially migrate creating a probable future hazard.

Attachment O
Company Operations Standard
Gas Standard
Gas Operations

Leakage Classification and Mitigation Schedules	SCG:	223.0125
--	-------------	-----------------

3.11.2.1.8. Any reading on a pipeline operating at greater than 60 PSIG that is not a Code 1 leak.

Note: For **Transmission and Storage**, pipelines operating at greater than 60 PSIG may be assigned a Code 3 leak category when the leak is confined to a valve casing and not in the surrounding soil. See Code 3 leak indications.

3.11.3. **CODE 3 LEAK INDICATION** - a leak that is not-hazardous at the time of detection and can reasonably be expected to remain not-hazardous.

Note: Permanent repairs must be scheduled and completed per section 4.1.3 of this Gas Standard.

3.11.3.1. Leak indications that do **not** meet Code 1 or Code 2 criteria should be classified as a Code 3.

Note: Includes leak indications that involve plastic pipe.

3.11.3.2. Examples of Code 3 leaks include, but are not limited to:

3.11.3.2.1. Any gas indications of less than 80% LEL (3.6% gas / air mixture) in small gas associated substructures and **in the surrounding soil**, such as but not limited to small curb meter boxes or gas valve boxes.

Note: Any gas indications of less than 80% LEL (3.6% gas / air mixture) in small gas associated substructures and **NOT in the surrounding soil**, such as but not limited to small curb meter boxes **will be classified** in accordance to section 3.12 and 4.2.

3.11.3.2.2. Any reading under a street in areas without wall-to-wall paving where it is unlikely the gas could migrate to the outside wall of a building.

3.11.3.2.3. **For Transmission and Storage**, leaks confined to a valve casing and not in the surrounding soil involving a pipeline operating at greater than 60 PSIG may be assigned a Code 3 leak category provided that the indications do not meet Code 1 or Code 2 criteria.

Leakage Classification and Mitigation Schedules	SCG:	223.0125
--	-------------	-----------------

Note: Permanent repairs must be scheduled and completed per section 4.1.3.2 of this Gas Standard.

3.12. ABOVE GROUND (NOT BURIED) LEAKS

3.12.1. **HAZARDOUS LEAK** - an above ground leak that represents an existing or probable hazard to persons or property, and requiring prompt action, immediate repair or continuous action until the leak is repaired and the conditions are no longer hazardous.

3.12.2. **NON-HAZARDOUS LEAK** - an above ground leak that is recognized as being not-hazardous at the time of detection, but justifies scheduled repair based on probable future hazard.

Note: Leaks at ground level (where buried pipe comes out of the ground) may be classified as an "above ground" leak, provided the area around the pipe is not paved, gas has not migrated away from the pipe, and the entire leaking area of pipe can be exposed by moving away top soil.

3.12.3. **MINOR LEAK** - An above ground leak determined to be non-hazardous and can be eliminated by tightening, lubrication, or adjustment.

Note: Main, Service, or Riser leaks caused by corrosion shall **NOT** be classified as Minor Leaks. Service valve leaks where the service valve must be replaced, the leak shall **NOT** be classified as a Minor Leak.

Leaks can be classified as Minor even if Company personnel elect to reconstruct the piping or replace parts; this includes activities such as replacing stem packing, gaskets, etc.

Attachment O
Company Operations Standard
Gas Standard
Gas Operations

Leakage Classification and Mitigation Schedules	SCG:	223.0125
--	-------------	-----------------

Table A: BELOW GROUND LEAK INDICATION CODING CRITERIA

LEAK INDICATION CODING	The corresponding leak indication coding applies to the conditions and actions listed below	
	CONDITIONS / ENVIRONMENT	ACTIONS (One or more actions may be required)
CODE 1	<ul style="list-style-type: none"> - Ignited leak - Leak is in a location where the gas could be ignited and pose an immediate danger to public or property. 	<ul style="list-style-type: none"> - Requires prompt action, immediate repair or continuous action until the leak is repaired and the conditions are no longer hazardous; - Evacuation; - Delineation to control public access; - Traffic delineation to control vehicular access; - Eliminating source of ignition; - Venting the area; - Stand-by; - Stopping the flow of gas by closing valves or other means; or - Notifying police and fire departments.
CODE 2	<ul style="list-style-type: none"> - Leak is not ignited. - Does not pose an immediate danger to public or property. - Is not hazardous at the time of detection but justifies scheduled repair based on the potential for creating a future hazard. 	Follow procedures in section 4.1.2.
CODE 3	<ul style="list-style-type: none"> - Does not pose an immediate danger to public or property. - Is not hazardous and is not expected to become hazardous. 	Follow procedures in section 4.1.3.

Note:

- The condition of the facility does not factor into the classification of the leak; however, pipe condition and structural integrity should be considered when determining the repair schedule. For Transmission, Storage, and Distribution



Attachment O
Company Operations Standard
Gas Standard
Gas Operations

Leakage Classification and Mitigation Schedules	SCG:	223.0125
--	-------------	-----------------

employees working on a system operating at greater than 60 PSIG, the pipe and facility condition shall also be assessed per Company Form Instruction **677-1**, *Pipeline Condition and Maintenance Report*.

- Refer to [GS 183.03](#), *Field Guidelines - Emergency Incident Distribution / Customer Service* for additional instructions.

Table B: ABOVE-GROUND LEAK INDICATION CLASSIFICATION CRITERIA

LEAK INDICATION CLASSIFICATION	The corresponding classification applies to the conditions and actions listed below	
	CONDITIONS / ENVIRONMENT	ACTIONS (One or more actions may be required)
HAZARDOUS	<ul style="list-style-type: none"> - Ignited leak. - Is in a location where the leak could be ignited and pose an immediate danger to public or property. - Leaks within 3ft of a building or structure that, when assessed by soap test, blows off leak soap. (Refer to GS 184.0150, <i>Leak Testing of Distribution Piping</i> for soap test information). 	<ul style="list-style-type: none"> - Requires prompt action, immediate repair or continuous action until the leak is repaired and the conditions are no longer hazardous; - Evacuation; - Delineation to control public access - Traffic delineation to control vehicular access; - Eliminating source of ignition; - Venting the area; - Stand-by; - Stopping the flow of gas by closing valves or other means; or - Notifying police and fire departments.
NON-HAZARDOUS	<ul style="list-style-type: none"> - Leak is not ignited. - Does not pose an immediate danger to public or property. - Leaks within 3ft of a building or structure that, when assessed by soap test forms soap bubble(s). (Refer to GS 184.0150, <i>Leak Testing of Distribution Piping</i> for soap test information). 	Follow procedures in section 4.2.2.
MINOR*	<ul style="list-style-type: none"> - Leaks or releases that are non-hazardous at the time of detection and can be repaired by tightening, lubrication, or adjustment. 	Follow procedures in section 4.2.3.

* Main, Service, or Riser leaks caused by corrosion are not classified as Minor Leaks. Service Valve leaks where the Service Valve must be replaced, the leak shall not be classified as a Minor Leak.

Leakage Classification and Mitigation Schedules	SCG:	223.0125
--	-------------	-----------------

Note: For Transmission, Storage, and Distribution employees working on an above ground system operating at greater than 60 PSIG, the pipe and facility condition shall also be assessed per Company Form Instruction **677-1, Pipeline Condition and Maintenance Report**.

4. PROCEDURE

4.1. Below Ground Leak Classification, Response and Mitigation

Note: All below ground leaks on DOT-defined Transmission, Storage and Distribution piping shall be coded and documented according to the definitions and criteria requirements within this gas standard.

4.1.1. Code 1 Leak Indications

4.1.1.1. All Code 1 leak indications require prompt action, immediate repair, or continuous action until the conditions are no longer hazardous. Temporary repairs may be made and documented to eliminate the immediate hazard. However, permanent repairs must be scheduled and completed per section 4.1.1 to 4.1.2 of this Gas Standard.

4.1.1.1.1. Actions taken for Code 1 leak indications in **Distribution, Transmission, and Storage** are in accordance with [GS 183.03, Field Guidelines - Emergency Incident Distribution / Customer Service](#) and [GS 223.0100, Leakage Surveys](#).

Note: The Supervisor of the organization repairing the leak must be notified for all Code 1 leaks.

4.1.1.2. Distribution

4.1.1.2.1. When a temporary repair is made on a Code 1 leak, the leak must be reevaluated using an approved Combustible Gas Indicator (CGI) at least once every 6 months.

4.1.1.2.1.1. Temporary leak repairs on pipelines operating at **60 PSIG or less** must be permanently repaired no later than 15 months from the original date detected.

4.1.1.2.1.2. Temporary leak repairs on pipelines operating at **greater than 60 PSIG** must be permanently

repaired within 1 year from the original date detected.

4.1.1.3. Transmission and Storage

4.1.1.3.1. When a Code 1 leak is temporarily repaired on a pipeline operating at greater than 60 PSIG, a permanent repair must be scheduled and completed within 6 months from the original date detected.

Note: In situations where permanent repairs cannot be completed within the six-months, the reason for delay and the steps taken to ensure public safety shall be documented monthly until the leak is permanently repaired, not to exceed one year from the original date detected

4.1.2. Code 2 Leak Indications

4.1.2.1. Distribution

4.1.2.1.1. Code 2 leak indications must be reevaluated, using an approved Combustible Gas Indicator (CGI), at least once every 6 months. The frequency of reevaluation should be determined by the location and magnitude of the leakage condition.

4.1.2.1.1.1. Leaks on a pipeline operating at **60 PSIG or less** must be permanently repaired or cleared within 15 months from the original date detected.

4.1.2.1.1.2. Leaks on a pipeline operating at **greater than 60 PSIG** must be permanently repaired or cleared within 1 year from the original date detected.

4.1.2.1.1.2.1. When a temporary repair is made on a Code 2 leak, the leak must be reevaluated using an approved Combustible Gas Indicator (CGI) at least once every 6 months.

4.1.2.1.1.2.2. Temporary leak repairs on a pipeline operating at **60 PSIG or less** must be permanently repaired no later than 15

Attachment O
Company Operations Standard
Gas Standard
Gas Operations

Leakage Classification and Mitigation Schedules	SCG:	223.0125
--	-------------	-----------------

months from the original date detected.

4.1.2.1.1.2.3. Temporary leak repairs on a pipeline operating at **greater than 60 PSIG** must be permanently repaired within 1 year from the original date detected.

4.1.2.1.2. In determining the repair schedule, the following criteria should be considered:

4.1.2.1.2.1. Amount and migration of gas.

4.1.2.1.2.2. Proximity of gas to buildings and subsurface structures.

4.1.2.1.2.3. Extent of pavement.

4.1.2.1.2.4. Soil type, and soil conditions (e.g., frost cap, moisture, natural venting).

4.1.2.1.3. Code 2 leak indications may vary greatly in degree of potential hazard and may justify a reason to expedite scheduled repair.

Note: In a situation where the Code 2 requires an earlier scheduled repair, the employee must contact supervision and share all pertinent information by the end of that working day. The Supervisor must take the necessary actions to bring these situations to the attention of the individual responsible for scheduling leakage repair to expedite the leak repair.

4.1.2.1.4. When leak indications are found in a Company-owned or controlled gas vault, entry into the vault is to be done in accordance with [GS 166.0077](#), *Confined Space Operations*.

4.1.2.2. Transmission and Storage

4.1.2.2.1. An investigation of a Code 2 leak indication shall be conducted within 6 weeks of the date detected, and repaired within 6 months of the date detected using normal operational methods.

4.1.2.2.2. Code 2 leak indications in the upper range of the lower explosive limit (2.5% - 3% gas / air mixture) shall be

Attachment O
**Company Operations Standard
Gas Standard
Gas Operations**

Leakage Classification and Mitigation Schedules

SCG:

223.0125

monitored pending the leak repair. The frequency for monitoring shall be defined by the supervisor.

Note: In situations where permanent repairs cannot be completed within the six-months, the reason for delay and the steps taken to ensure public safety shall be documented monthly until the leak is permanently repaired not to exceed one year from the original date detected

4.1.2.2.3. When leak indications are found in a Company-owned or controlled gas vault, entry into the vault is to be done in accordance with [GS 166.0077](#), *Confined Space Operations*.

4.1.3. Code 3 Leak Indications

4.1.3.1. **Distribution**

4.1.3.1.1. Code 3 leak indications must be reevaluated, using an approved Combustible Gas Indicator (CGI) and on intervals based on the piping material in the area of the leak indication:

Steel: At least once every calendar year, not to exceed 15 months until the leak is repaired. **The leak must be repaired or cleared no later than 3 years from the original date detected.**

Plastic: At least once every 6 months until a permanent repair is completed, leak is cleared. The leak must be repaired or cleared no later than 15 months from the original date detected.

4.1.3.2. **Transmission and Storage**

4.1.3.2.1. Leaks confined to a valve casing and not in the surrounding soil may be assigned a Code 3 leak category

Leakage Classification and Mitigation Schedules	SCG:	223.0125
--	-------------	-----------------

provided that the indications do not meet Code 1 or Code 2 criteria.

4.1.3.2.1.1. Code 3 leak indications must be permanently repaired / or cleared upon discovery or within one year from the original date detected.

4.2. Above Ground Leak Classification, Response and Mitigation

Note: Above ground leaks on DOT-defined Transmission, Storage and Distribution piping shall be classified according to the definitions and criteria specified within this gas standard as Hazardous, Non-Hazardous, or Minor. The response and mitigation schedule for leaks on Above Ground Facilities shall be as follows:

4.2.1. Hazardous Leaks On Above Ground Pipelines

4.2.1.1. All Hazardous leak indications require prompt action, immediate repair or continuous action until the leak is repaired and the conditions are no longer hazardous.

4.2.1.1.1. Hazardous Riser and MSA leaks require an immediate response and continuous action until a permanent repair is made.

4.2.1.2. Distribution

4.2.1.2.1. When a temporary repair is made on a Hazardous leak, the leak must be reevaluated at least once every 6 months.

4.2.1.2.1.1. Temporary leak repairs on pipelines operating at 60 PSIG or less must be permanently repaired no later than 15 months from the original date detected.

4.2.1.2.1.2. Temporary leak repairs on pipelines operating at greater than 60 PSIG must be permanently repaired within 1 year from the original date detected.

4.2.1.3. Transmission and Storage

4.2.1.3.1. When a Hazardous leak is temporarily repaired on a pipeline operating at greater than 60 PSIG, a permanent

Attachment O
**Company Operations Standard
Gas Standard
Gas Operations**

Leakage Classification and Mitigation Schedules	SCG:	223.0125
--	-------------	-----------------

repair must be scheduled and completed within 6 months from the original date detected.

Note: In situations where permanent repairs cannot be completed within the six-months, the reason for delay and the steps taken to ensure public safety shall be documented monthly until the leak is permanently repaired not to exceed one year from the original date detected.

4.2.1.3.2. The Supervisor of the organization repairing the leak must be notified for all Hazardous leaks. The Supervisor shall notify management immediately for all Hazardous leaks.

4.2.2. Non-Hazardous Leaks

4.2.2.1. When determining repair schedule for non-hazardous leaks, the proximity of gas to buildings and structures shall be considered.

4.2.2.2. **Distribution**

4.2.2.2.1. Leaks within 3 feet of a building or structure, shall be repaired within 2 business days (see Exception and Note below) from the date the leak was detected.

Exception: For leaks that require excavation to repair, the repair schedule shall be adjusted in accordance with company operations practices as soon as practical, not to exceed 10 business days. CSF employees shall refer to [GS 142.02](#), *Leak Investigation - Customer Service*.

Note: One-Call / USA notification requires 2 business days for non-emergency response by other utilities before excavating. Refer to [GS 184.0200](#) *Underground Service Alert and Temporary Marking* for more information.

CA law AB1937 requires a notification of 3 business days to qualifying School, Hospital and / or Registered Licensed Day Care Facility within 500 feet proximity

Leakage Classification and Mitigation Schedules	SCG:	223.0125
--	-------------	-----------------

prior to planned construction excavation activity on gas facilities.

- 4.2.2.2.2. Leaks greater than 3 feet from a building or structure that is not in a remote location, the leak must be repaired within 6 months from the date the leak was detected.
- 4.2.2.2.3. Leaks in remote locations that are considered non-hazardous must be permanently repaired within 15 months from the original date detected.
 - 4.2.2.2.3.1. When a temporary repair is made on a Non Hazardous leak, the leak must be reevaluated at least once every 6 months.
 - 4.2.2.2.3.2. Temporary leak repairs on pipelines operating **60 PSIG or less** must be permanently repaired no later than 15 months from the original date detected.
 - 4.2.2.2.3.3. Temporary leak repairs on pipelines operating at **greater than 60 PSIG** must be permanently repaired within 1 year from the original date detected.
- 4.2.2.2.4. All non-hazardous riser leaks may be temporarily repaired using company approved clamps.
 - 4.2.2.2.4.1. When a temporary leak repair is made on an Anodeless riser, the clamp (stock code N542491) shall be installed in accordance with [GS 184.0121](#), *Service Riser Integrity Inspection*. Temporary leak repairs must be scheduled and permanently repaired as soon as practical, **not to exceed 10 business days from the date the temporary clamp was installed**.
 - 4.2.2.2.4.2. When temporary leak repairs are made on a steel riser, the leak must be reevaluated at least once every 6 months and a permanent repair must be completed within 15 months from the date the leak was detected.
- 4.2.2.2.5. Shorter time frames for the response to Non-Hazardous Leaks may be scheduled when in the opinion of the

Attachment O
Company Operations Standard
Gas Standard
Gas Operations

Leakage Classification and Mitigation Schedules	SCG:	223.0125
--	-------------	-----------------

responsible employee it is prudent for managing safety, public relation reasons, or other special considerations.

- 4.2.2.2.6. When leak indications are found in a Company-owned or controlled gas vault, entry into the vault is to be done in accordance with [GS 166.0077](#), *Confined Space Operations*.

4.2.2.3. Transmission and Storage

- 4.2.2.3.1. When determining repair schedule for all non-hazardous leaks, the proximity of gas to buildings and structures shall be considered.
- 4.2.2.3.2. An investigation of a Non-Hazardous leak indication shall be conducted within 6 weeks of the date detected, and repaired within 6 months of the date detected using normal operational methods.

Note: Leaks within 3 feet of a building or structure shall be repaired within 2 business days (see Exception and note after 4.2.2.2.1) from the date the leak was detected.

- 4.2.2.3.3. Non-Hazardous leak indications in the upper range of the lower explosive limit (2.5% - 3% gas / air mixture) shall be monitored pending the leak repair. The frequency for monitoring shall be defined by the supervisor.

Note: In situations where permanent repairs cannot be completed within the six-months, the reason for delay and the steps taken to ensure public safety shall be documented monthly until the leak is permanently repaired, not to exceed one year from the original date detected.

- 4.2.2.3.4. When leak indications are found in a Company-owned or controlled gas vault, entry into the vault is to be done

Leakage Classification and Mitigation Schedules	SCG:	223.0125
--	-------------	-----------------

in accordance with [GS 166.0077](#), *Confined Space Operations*.

4.2.3. Minor Leak

- 4.2.3.1. ~~Repairs are to be scheduled and performed as operations permit. The leak must be repaired or cleared no later than 3 years from the original date detected.~~

5. OPERATOR QUALIFICATION COVERED TASKS

(See [GS 167.0100](#), *Operator Qualification Program, Appendix A, Covered Task List*):

- **Task 09.01** - 49 CFR 192.706 - Performing leakage surveys: transmission lines.
- **Task 09.02** - 49 CFR 192.723 - Performing leakage surveys: distribution systems.
- **Task 09.04** - 49 CFR 192.703, 192.723(b) - Distribution Systems: Leakage Investigations.
- **Task – 09.05** - CFR 192.703, 192.723(b) - Leakage Assessment.
- **Task 09.06-9999** - 49 CFR 192.703 - Above Ground Leak Classification.

6. RECORDS

- 6.1. **Data Requirements For Above Ground Leaks:** Minor leaks, Above Ground Hazardous and Non-Hazardous leaks are to be documented by each impacted operating organization. The minimum required data includes the leak Classification, Cause, and Component category.
- 6.2. **Transmission / Storage:** Leak records are documented on [Form 677-1](#), *Pipeline Condition and Maintenance Report*. For all documentation instructions and requirements, refer to [Form 677-1](#), *Pipeline Condition and Maintenance Report* company form instructions. The PCMR can be completed electronically or paper forms
- 6.3. **Distribution:** Leak records are documented as follows:
- **Form 4040**, Leak Investigation Order.
 - **Form 4060**, Leak Re-Evaluation Order.
 - **Form 7010**, *Leak Repair Order*, Leak repairs on mains, services and risers.
 - **Form 4070**, *Leak repair Order*, Leak repair on the MSA.
 - [Form 677-1](#), *Pipeline Condition and Maintenance Report* (PCMR), when a leak is repaired on a pipeline operating at greater than 60 PSIG, a description and all pertinent information concerning the repair(s) or any other disposition of the leak is made on **Form 677-1**; CM work orders and PCMRs are to be

Attachment O
Company Operations Standard
Gas Standard
Gas Operations

Leakage Classification and Mitigation Schedules	SCG:	223.0125
--	-------------	-----------------

cross referenced. CM orders are completed and electronically filed in SAP. PCMRs are completed and filed according to [Form 677-1](#) instructions.

- 6.4. **Measurement and Regulation:** Distribution M&R inspections and leak repairs are captured by CLICK Mobile. Transmission M&R inspections and leak repairs are captured by a PDF version of the form. Above Ground Leaks will be captured using Leak Classification & Repair Form (**Form 5290** for FL and **Form 5590** for EQ).
- 6.5. **Customer Service Field:** Leak records are documented in PACER and shall include the leak classification, cause, facility location, leaking component, conditions found, and a description of the subsequent repairs or other disposition of the leak.
- 6.6. Records of leaks discovered, and repairs made are filed by the appropriate Transmission District, Storage Field, Customer Service or Distribution operating organizations.
- 6.7. **Transmission Lines: Recordkeeping:**
 - 6.7.1. All records of leaks discovered and repaired are kept on file at Gas Transmission in MAXIMO.
 - 6.7.2. All leaks found and not immediately repaired must have a corrective MAXIMO work order completed.
 - 6.7.3. Retain original paper order in file per Records Management Retention Schedule. See Records Retention Standards on Sempra Net, <http://home.sempranet.com/rm/> .
 - 6.7.4. In addition to the other recordkeeping requirements of these rules, each Operator shall maintain the following records for transmission lines for the periods specified:
 - A. The date, location, and description of each repair made to pipe (including pipe-to-pipe connections) must be retained for as long as the pipeline remains in service or there is no longer pipe within the system of the same manufacturer, size and / or vintage as the pipeline on which repairs are made, whichever, is longer.
 - B. The date, location, and description of each repair made to parts of the pipeline system other than pipe must be retained for at least 75 years. Repairs or findings of easement encroachments, generated by patrols, surveys, inspections, or tests required by subparts L and M of 49 CFR



Attachment O
**Company Operations Standard
Gas Standard
Gas Operations**

Leakage Classification and Mitigation Schedules	SCG:	223.0125
--	-------------	-----------------

Part 192 must be retained in accordance with paragraph (c) of this section.

- C. A record of each patrol, survey, inspection, and test required by subparts L and M of this part must be retained for at least 75 years.

INTERNAL



Attachment O
Company Operations Standard
Gas Standard
Gas Operations

Leakage Classification and Mitigation Schedules	SCG:	223.0125
--	-------------	-----------------

NOTE: Do not alter or add any content from this page down; the following content is automatically generated.

Brief: The Policy was revised for clarity and to meet the requirements contained in GO 112 F. The changes shall be reviewed by all employees who are qualified to Code or Classify Leaks. Removed Interim Information dated 10-14-2013. Section 1, Policy and Scope was revised for clarity: Added a note after 1.3 for guidance and requirements in situations where a leak requires an earlier scheduled repair. Section 2, Updated Responsibility and Qualifications: Added a new section 2.1 – Pipeline Integrity, Added a new section 2.2 - Gas Operations Staff and Technical Service, Added a new section 2.6 – Company Department, Added a new section 2.7 - Gas Operations Training. Section 3, Definitions (added, removed or revised): Added 3.1 through 3.1.1 - Explosive Limits for Natural Gas, Added 3.3 – Temporary Repair and note, Added 3.5 – Leak, Added 3.6 through 3.6.2– Leakage Coding, Added 3.7 – Leak Concentration, Transmission and Storage, see 3.7 and note, Added 3.8- MSA Leaks and note, Riser Leaks and note, Added 3.9 – Riser Leaks and note, Added 3.10 - Buried Leaks and note, Revised 3.11 through 3.11.3.2.3 - Added and or revised Code 1, Code 2 and Code 3 examples: Code 1: Revised section 3.11.1, Added note after section 3.11.1, Revised section 3.11.1.1.2, Revised section 3.11.1.1.3, Added section 3.11.1.1.5, Added section 3.11.1.1.7. Code 2: Revised Section 3.11.2, Added a note after section 3.11.2, Added section 3.11.2.1.1, Added section 3.11.2.1.3, Added section 3.11.2.1.5, Added section 3.11.2.1.7, Added a note after 3.11.2.1.8 for Transmission and Storage. Code 3: Revised section 3.11.3, Added note after 3.11.3.2.1 through 3.11.3.2.2, Added a new Code 3 leak for Transmission and Storage. See section 3.11.3.2.3. Removed below ground Minor Leak Indications confined to a valve casing. Revised 3.12 through 3.12.3 – Added and or revised Above Ground (not buried) Leaks for clarity (Hazardous, Non Hazardous and Minor leaks). Hazardous Leak: Revised 3.12.1. Minor Leak: Revised note after 3.12.3. Revised and Updated Table A and Table B for clarity. Section 4, Procedures: There were changes to below ground Code 1, Code 2, and Code 3 Leak verbiage: Revised 4.1.1 – added code 1 leak indications require prompt action. Revised section 4.1.1.1- added Transmission and Storage Added 4.1.1.2 through 4.1.1.2.1.2 - Code I leak repair for Distribution Added sections 4.1.1.3 through 4.1.1.3.2 – Code 1 Leak repair for Transmission and Storage. Revised section 4.1.2.1.1- Code 2 leak indications must be reevaluated, using an approved Combustible Gas Indicator (CGI), at least once every 6 months. Added 4.1.2.1.1.1 – Code 2 leak repair for pipeline operating at 60 PSIG or less. Added 4.1.2.1.1.2.2 – Code 2 leak repair for pipeline operating greater than 60 PSIG. Added 4.1.2.1.1.2.1 through 4.1.2.1.1.2.3 – Temporary leak repair requirements for code 2 leaks. Revised 4.1.2.1.2 – Code 2 leak repair schedule criteria provided by adding sections 4.1.2.1.2.1 through 4.1.2.1.2.4. Revised 4.1.2.1.3 – Added Note requiring supervisor notification for earlier scheduled repair of code 2 leaks. Revised ion 4.1.2.2 – Transmission and Storage: 4.1.2.2.2 – Documentation requirements for code 2 leaks that cannot be repaired within prescribed timeframe. 4.1.2.2.3 – refers to GS 166.0077, Confined Space Operations for leaks found in Company-owned or controlled gas vaults. Revised 4.1.3 Code 3 Leak Indications: Added 4.1.3.1 through 4.1.3.1.1- Code 3 leak repair and reevaluate requirements for Distribution. Added sections 4.1.3.2 through 4.1.3.2.1.2 – Code 3 leak repair requirements for Transmission and Storage. Added 4.1.3.2.1- Leaks confined to a valve casing and not in the surrounding soil may be assigned a Code 3 leak category. Revised sections 4.2.1- through 4.2.1.1.1- Hazardous Leaks on Above Ground Pipelines: Revised 4.2.1.1 – All Hazardous leak indications require prompt action. Revised 4.2.1.1.1 - Hazardous Riser and MSA leaks require an immediate response and continuous action until a permanent repair is made. Added Sections 4.2.1.2 through 4.2.1.2.1.2 – Above Ground leak repair and reevaluate requirements for Distribution. Added 4.2.1.3 through 4.2.1.3.2 – Above Ground leak repair requirements for Transmission and Storage. Revisions made to 4.2.2 Non-Hazardous Leaks: Added sections 4.2.2.2 through 4.2.2.2.6 – Non-Hazardous Leak requirements for Distribution. Added note to section 4.2.2.2. - repair schedule for leak repairs requiring excavation shall be adjusted in accordance with company operations not to exceed 10 business days. Added note to 4.2.2.2 – Providing One-call/USA and CA Law AB1937 notification requirements. Added 4.2.2.2.4.1 – Provides leak repair requirements for Anodeless risers. Added section 4.2.2.2.4.2 – Provides leak repair and reevaluate requirements for steel risers. Added 4.2.2.2.6 – Refers to GS 166.0077, Confined Space Operations for Non-Hazardous leaks found in Company-owned or controlled gas vault. Added 4.2.2.3 through 4.2.2.3.4 -Non-Hazardous Leak requirements for Transmission and Storage. Section 4.2.2.3.2- Provides documentation



Attachment O
Company Operations Standard
Gas Standard
Gas Operations

Leakage Classification and Mitigation Schedules	SCG:	223.0125
--	-------------	-----------------

requirements for Non- Hazardous leaks that cannot be repaired within prescribed timeframe. Section 4.2.2.3.3 provides monitoring requirements for Non-Hazardous leak indications in the upper range of the Lower Explosive Limit (2.5% - 3% gas air mixture). Note- provides documentation requirements for situations where permanent repairs of Non-Hazardous leaks cannot be made within six months. Section 4.2.2.3.4 - Refers to GS 166.0077, Confined Space Operations for Non-Hazardous leaks found in Company-owned or controlled gas vault. Section 5, Operator Qualification Task: Removed Task 3.1 - 49 CFR 192.503(d) - Leak Testing non-welded joints. Added Task 9.4 - 49 CFR 192.703, 192.723(b) - Distribution Systems: Leakage Investigations. Added Task 9.5 CFR 192.703, 192.723(b) - Leakage Assessment. Section 6, Records - Updated record requirements: Removed original 6.1.1 – Leak Cause, Added new section 6.7 - Transmission Lines: Recordkeeping which includes the new record retention schedule. Several of the “shall” were changed to “must”. Minor word changes throughout document for clarity.

Document Profile Summary	
Responsible Person:	[REDACTED]
Published On:	12/19/2016
Last Full Review Completed On:	12/16/2016
Writer:	[REDACTED]
Document Status:	Active
Document Type:	GAS
Category (Prior FCD system only):	
If Merged, Merged To Document Number:	
Utility:	SoCalGas
Department:	Staff & Technical Services
Number of Common Document (if applicable):	G8135
Contains OPQUAL Covered Task:	Yes
Part of SoCalGas O&M Plan:	Yes
Part of SDG&E O&M Plan:	No
Last O&M Review date:	2017-11-29
O&M 49 CFR Codes & Impacted Sections of Document:	192.709(c): 6.7 192.703(c): 1.2, 3.11.1, 3.12.1, Table A, Table B, 4.1.1, 4.2.1 192.605(b)(3): 6
Part of Non-O&M Parts 191-193 Plan	No
Non-O&M 49 CFR Codes & Impacted Sections of Document	
Part of Distribution IMP (DIMP)	Yes
Part of Transmission IMP (TIMP)	Yes
Part of Storage IMP (SIMP)	No
Impacts GO112F	Yes
GO112F Codes & Impacted Sections of Document	145.1: (a)(b)1, 4, 6, (c)1, 6 143.2: Entire Document
Impacts GO58A	No
GO58A Codes & Impacted Sections of Document	
Impacts GO58B	No
GO58B Codes & Impacted Sections of Document	
Indices/Binders in Which Document is Filed:	TRAN, TIMP2, STOR, MS, LSDP, DISTM, DIMP2, CSF
NOP Learning Module (LM) Training Code:	NOP00607

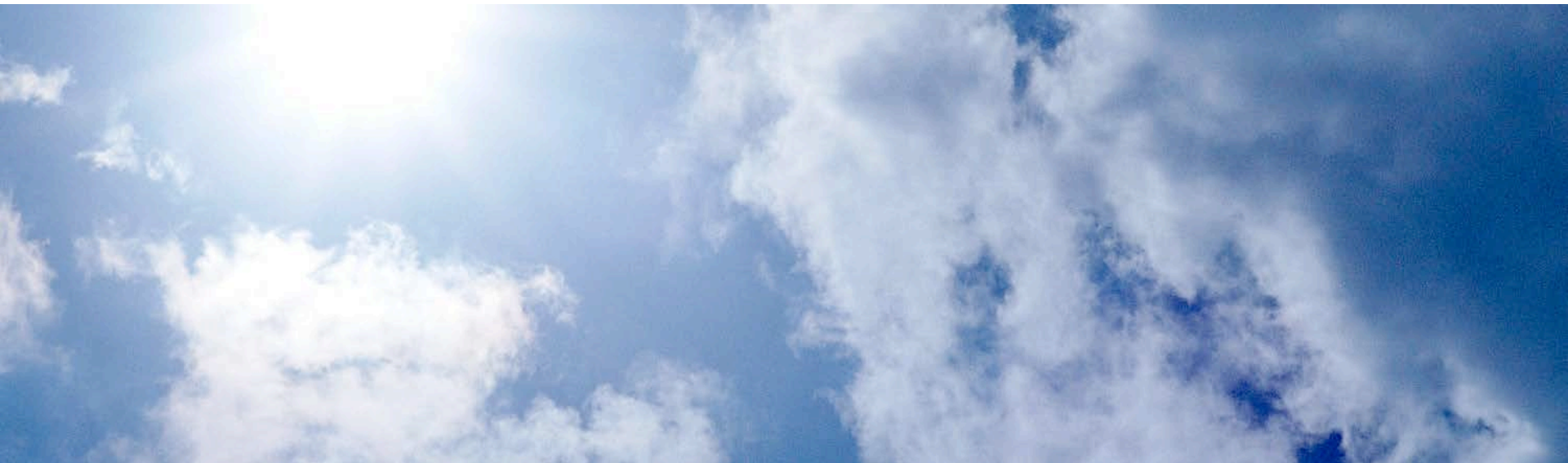

Technology Transfer workshop: Pipeline Blowdowns in Transmission and Distribution

Deanna Haines, Director of Gas Engineering
Southern California Gas Company and San Diego Gas & Electric

November 10, 2016

EPA's Natural Gas STAR and Methane Challenge Programs

PREVIEW

- WHO WE ARE
- DRIVERS
- CASE STUDIES
- SUMMARY

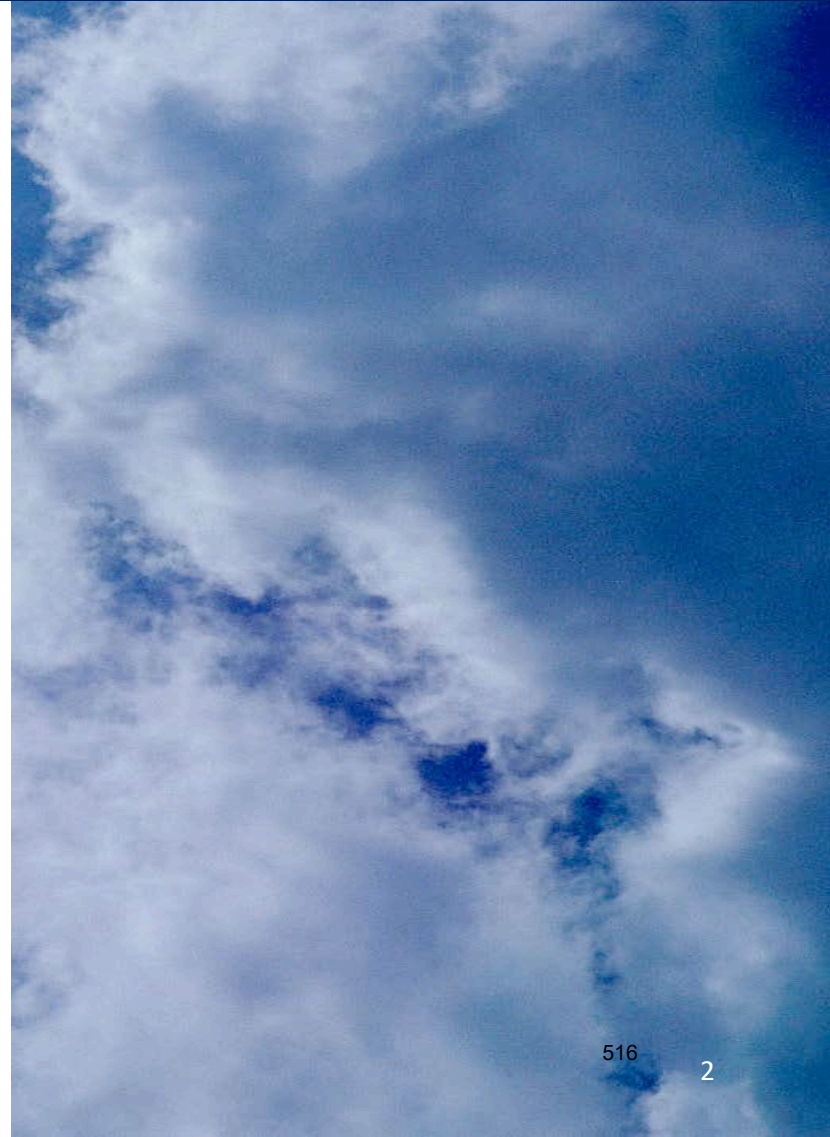

WHO WE ARE...

SoCalGas & SDG&E Territory



Both Utilities in service for over **135 years**

SoCalGas

- **Largest natural gas distribution** utility in the US
- Serve **12 counties** (over 500 communities) and more than **21 million** people
- Over **5.8** million gas meters

SDG&E

- Provides **electricity** and **natural gas** to **3.4 million** people from Orange County to the Mexican border.

Routine Maintenance

- ✓ 30-Pipeline Integrity
- ✓ 60-Pipeline alterations

Pipeline Safety Enhancement plan

- ✓ 60-hydrotests, replacements



Blowdown Mitigations



Methane Capture System-newly employed



Pressure Reduction Using Mobile Compressors-common



Transfer of Gas to Lower Pressure System-common



Isolate Small Section Using Stopples-infrequently



Flaring-haven't used this method (introduces new safety, fire risks not normally part of operation)

Blowdown Mitigation Options

- **Methane Capture System using Mobile Compressors**
 - Compress pipeline gas into Compressed Natural Gas(CNG) tube trailer
 - Re-introduce gas into pipeline

- **Success story.....**
 - 2.5-miles of a 10-inch pipeline operating at 370-psig – In urban area
 - 155-mscf gas mitigated from venting to atmosphere
 - 130-mscf stored in CNG tube trailer
 - Portable compressor compressed gas into a CNG tube trailer
 - Compressor powered by natural gas generator
 - 25-mscf used to power natural gas generator
 - 23-mscf gas vented to atmosphere
 - 38-psig final pressure in isolated pipeline segment



Option	Pipeline Pressure		Blowdown Reduction	Reduction in CH4 Emitted	Gas Removal Rate	Duration of Mitigation Operation	Compressor Fuel use Natural Gas	CO2 Emissions
	Starting (psig)	Ending (psig)	%	Intrastate (MT/event)	(Mcf/hr)	Intrastate (hr/event)	Intrastate (Mcf/event)	Intrastate (MT/event)
Mobile Compressor (MJB&A)	400	80	80%	57.3	500	5.6	34	1.9
Methane Capture (SoCalGas/SDG&E)	370	38	90%	3.2	31	5	25*	0.2*

Option	Total Cost Per event	Economic Value of Saved Gas Natural Gas (Intrastate)	net of Natural Gas Economic Value (Intrastate)	Methane Mitigation Cost (Intrastate)	Methane Mitigation Cost Net of NG Economic Value (Intrastate)
	\$/event	\$/event	\$/event	\$/MT	\$/MT
Mobile Compressor (MJB&A)	\$13,282	\$11,688	\$1,594	\$232	\$28
Methane Capture (SoCalGas/SDG&E)	\$8,979	\$653	\$8,327	\$2,803	\$21

Blowdown Mitigation Options

- **Pressure Reduction with Mobile Compressors**
 - **Compress gas from isolated pipeline segment into parallel pipeline.**
- **Success story.....**
 - **40-miles of 30-inch pipeline operating at 400-psig – in remote area**
 - **25,000-mscf gas mitigated from venting to atmosphere**
 - **(2) 300-hp portable compressors to compress gas into parallel pipeline.**
 - **5,000-mscf gas vented to atmosphere**

Option	Pipeline Pressure		Blowdown Reduction	Reduction in CH4 Emitted	Gas Removal Rate	Duration of Mitigation Operation	Compressor Fuel use Natural Gas	CO2 Emissions
	Starting (psig)	Ending (psig)	%	Intrastate (MT/event)	(Mcf/hr)	Intrastate (hr/event)	Intrastate (Mcf/event)	Intrastate (MT/event)
Mobile Compressor (MJB&A)	400	80	80%	57.3	500	5.6	34	1.9
Mobile Compressor (SoCalGas/SDG&E)	357	61	83%	408.5	212	93		

Option	Total Cost Per event	Economic Value of Saved Gas Natural Gas (Intrastate)	net of Natural Gas Economic Value (Intrastate)	Methane Mitigation Cost (Intrastate)	Methane Mitigation Cost Net of NG Economic Value (Intrastate)
	\$/event	\$/event	\$/event	\$/MT	\$/MT
Mobile Compressor	\$13,282	\$11,688	\$1,594	\$232	\$28
Mobile Compressor (SoCalGas/SDG&E)	\$7,213	\$105,250	(\$98,037)	\$18	\$495



Transfer to Lower Pressure System

Option	Pipeline Pressure		Blowdown Reduction	Reduction in CH4 Emitted	Gas Removal Rate	Duration of Mitigation Operation	Compressor Fuel use Natural Gas	CO2 Emissions
	Starting (psig)	Ending (psig)						
Mobile Compressor (MJB&A)	400	80	80%	57.3	500	5.6	34	1.9
Inject to Low Pressure System (SoCalGas/SDG&E)	400	45	89%	107.5	13.4	8	N/A	N/A

- **Utilize city gate or distribution station to reduce volume.**
 - **8-miles of 30-inch pipeline operating at 400-psig**
 - **5,200-mscf gas mitigated from venting to atmosphere**
 - **Used medium pressure system to draw down pipeline to 45-psig**
 - **800-mscf gas vented to atmosphere**



Summary

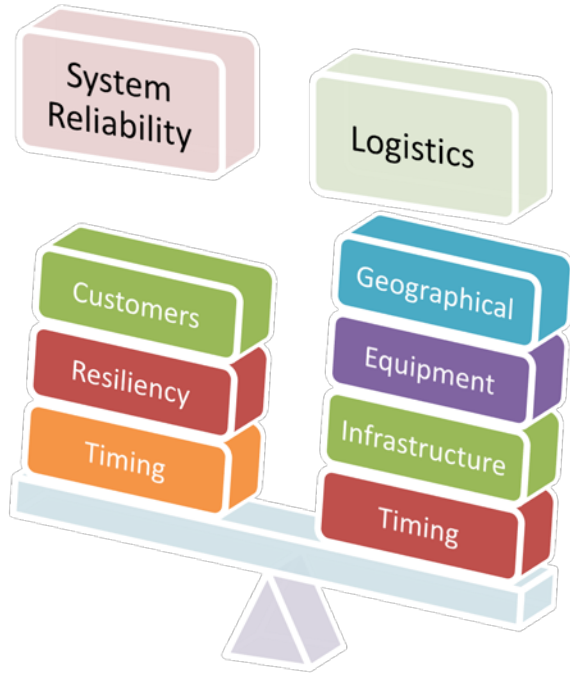

Key Constraints

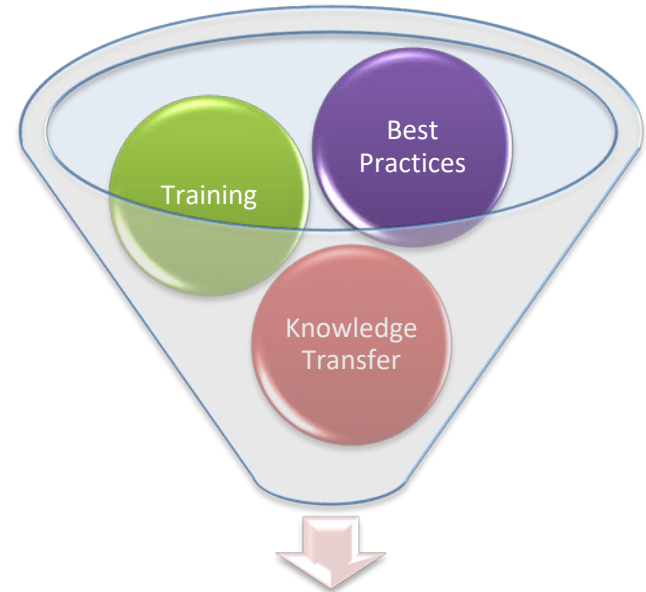

Success Factors

Blowdown Mitigation Options

- **Methane Capture System using Mobile Compressors**
 - Compress pipeline gas into Compressed Natural Gas(CNG) tube trailer
 - Re-introduce gas into pipeline

- **Success story.....**
 - 2.5-miles of a 10-inch pipeline operating at 370-psig – In urban area
 - 155-mscf gas mitigated from venting to atmosphere
 - 130-mscf stored in CNG tube trailer
 - Portable compressor compressed gas into a CNG tube trailer
 - Compressor powered by natural gas generator
 - 25-mscf used to power natural gas generator
 - 23-mscf gas vented to atmosphere
 - 38-psig final pressure in isolated pipeline segment



Option	Pipeline Pressure		Blowdown Reduction	Reduction in CH4 Emitted	Gas Removal Rate	Duration of Mitigation Operation	Compressor Fuel use Natural Gas	CO2 Emissions
	Starting (psig)	Ending (psig)	%	Intrastate (MT/event)	(Mcf/hr)	Intrastate (hr/event)	Intrastate (Mcf/event)	Intrastate (MT/event)
Mobile Compressor (MJB&A)	400	80	80%	57.3	500	5.6	34	1.9
Methane Capture (SoCalGas/SDG&E)	370	38	90%	3.2	31	5	25*	0.2*

Option	Total Cost Per event	Economic Value of Saved Gas Natural Gas (Intrastate)	net of Natural Gas Economic Value (Intrastate)	Methane Mitigation Cost (Intrastate)	Methane Mitigation Cost Net of NG Economic Value (Intrastate)
	\$/event	\$/event	\$/event	\$/MT	\$/MT
Mobile Compressor (MJB&A)	\$13,282	\$11,688	\$1,594	\$232	\$28
Methane Capture (SoCalGas/SDG&E)	\$8,979	\$653	\$8,327	\$2,803	\$21

Public Utilities Commission of the State of California

Energy Division

Resolution G-3257
August 5, 1999G.O. 58-A
FileR e s o l u t i o n

Resolution G-3257. Sempra Energy on behalf of Southern California Gas Company requests the Commission's approval to adopt a gas meter testing methodology according to Section 14 of General Order 58-A, *Standards for Gas Service in the State of California*. The Commission authorizes Southern California Gas Company to test and confirm rotary gas meter accuracy using the differential pressure testing method but requires Southern California Gas Company to use transfer provers to comply with the ten year retest requirement.

By letter dated March 12, 1999, from Sempra Energy Company.

Summary

On March 12, 1999, Sempra Energy (Sempra) on behalf of Southern California Gas Company (SoCal Gas) requested authority to: (1) adopt differential pressure testing as an acceptable method of testing rotary gas meters for accuracy; and (2) revise its gas meter performance program to accept differential testing as a meter performance tool. This request was submitted in accordance with Sections 13(c) and 14 of General Order 58-A (GO 58-A). On June 3, 1999, SoCal Gas withdrew Part (2).

SoCal Gas needs Commission approval per Section 14 of GO 58-A to adopt the new testing methodology.

This Resolution allows SoCal Gas to use the differential pressure testing methodology, but SoCal Gas is still required to use transfer provers to comply with the requirement to retest every ten years. Differential pressure testing is not mandatory; however, SoCal Gas must adhere to certain terms and conditions when it uses this test method.



Attachment R
Company Operations Standard
Gas Standard
Gas Operations & System Integrity

Public Awareness Plan	SCG:	PA-1
------------------------------	-------------	-------------

Table of Contents

1. OVERALL GOAL	3
1.1. OBJECTIVES	4
2. MANAGEMENT COMMITMENT TO ACHIEVING EFFECTIVE PUBLIC AWARENESS	5
3. ROLES AND RESPONSIBILITIES	7
4. OVERALL COMMUNICATIONS STRATEGY	9
5. IDENTIFICATION OF STAKEHOLDER AUDIENCES	9
6. MESSAGE CONTENT	13
7. SUMMARY AND RATIONALE OF PLANNED COMMUNICATIONS BY AUDIENCE	17
7.1. AFFECTED PUBLIC: CUSTOMERS	17
7.2. AFFECTED PUBLIC WITHIN DISTRIBUTION SERVICE TERRITORIES	20
7.3. AFFECTED PUBLIC ALONG TRANSMISSION LINES INSIDE AND OUTSIDE OF DISTRIBUTION SERVICE TERRITORY	21
7.4. AFFECTED PUBLIC NEAR COMPRESSOR STATIONS AND STORAGE FIELDS	23
7.5. UNIQUE ASSET: BORREGO SPRINGS LIQUEFIED NATURAL GAS FACILITY	24
7.6. AFFECTED PUBLIC: SCHOOLS	25
7.7. EMERGENCY OFFICIALS/COUNTY COORDINATORS	26
7.8. LIAISON WITH EMERGENCY RESPONDERS	29
7.9. PUBLIC OFFICIALS	30
7.10. CONTRACTORS WHO EXCAVATE, FARMERS, AND LAND DEVELOPERS	33
7.11. EMPLOYEES – SUPPLEMENTAL COMMUNICATIONS	35
8. CONSIDERATION OF RELEVANT FACTORS	37
9. RECORD KEEPING	39
10. PROGRAM EVALUATION AND CONTINUOUS IMPROVEMENT	39
10.1. ANNUAL PROGRAM IMPLEMENTATION AUDIT	39
10.2. EFFECTIVENESS EVALUATION	40
11. PROGRAM CHANGES	40
APPENDIX	42
APPENDIX A. PUBLIC AWARENESS SUPPORT TEAM MEMBERS	42
APPENDIX B. OTHER LANGUAGES PROVIDED	45
APPENDIX C. IDENTIFICATION OF SCHOOLS	46
APPENDIX D. SAMPLING MARGIN OF ERROR	47
APPENDIX E. PROCEDURE TO DEVELOP SHAPE FILES AND MAILING LIST OF AFFECTED PUBLIC NEAR PIPELINES OR FACILITIES	48
APPENDIX F. OVERVIEW OF PIPELINE ASSOCIATION FOR PUBLIC AWARENESS’ (PAPA) EMERGENCY RESPONDER PROGRAM	49
APPENDIX G. OVERVIEW OF PIPELINE ASSOCIATION FOR PUBLIC AWARENESS’ (PAPA) PUBLIC OFFICIALS PROGRAM	51
APPENDIX H. VENDOR’S AUDIENCE IDENTIFICATION VERIFICATION PROCESS AND MEASUREMENTS OF REACH	53
APPENDIX I. RETURN AND UNDELIVERABLE MAILING INSTRUCTIONS	55
APPENDIX J. METHOD OF COMMUNICATION AND DOCUMENTATION	56
APPENDIX K. COMMUNICATIONS REQUIRED BY TARGETED AUDIENCE	57
APPENDIX L. THIRD-PARTY VENDORS	62



A Sempra Energy utility

Attachment R

Company Operations Standard Gas Standard

Gas Operations & System Integrity

Public Awareness Plan	SCG:	PA-1
------------------------------	-------------	-------------

APPENDIX M. PROGRAM IMPLEMENTATION PROCESS.....63

APPENDIX N. REVIEW AND REVISION LOG64

APPENDIX O. EXECUTIVE SPONSOR SIGNATORY AFFIRMATION.....67

GLOSSARY68

INTERNAL



Attachment R
**Company Operations Standard
 Gas Standard
 Gas Operations & System Integrity**

Public Awareness Plan	SCG:	PA-1
------------------------------	-------------	-------------

**Public Awareness Plan
 for
 Southern California Gas Company (SoCalGas) and
 San Diego Gas & Electric (SDG&E)
 Version Date: 4/4/2014**

1. Overall Goal

The goal of the Public Awareness Program is to enhance public safety and property protection through improved public awareness and to comply with Federal Regulations 49 CFR 192.616, Public Awareness. Additionally, public awareness type communication requirements from other regulations are documented in this plan. There will be one Public Awareness Program incorporating all SoCalGas and SDG&E pipeline and associated facilities as specified below:

Distribution Pipelines:	SoCalGas 50,356 miles ¹ SDG&E 8,071 miles ²
Services:	SoCalGas 49,516 miles SDG&E 6,018 miles
Transmission Pipelines:	SoCalGas 3,455 miles ³ SDG&E 225 miles ⁴
Compressor Stations:	SoCalGas (11): Adelanto, Blythe, Cactus City, Desert Center, Kelso, North Needles, South Needles, Newberry, Wheeler Ridge, Sylmar, and Ventura SDG&E (2): Moreno ⁵ and Rainbow

¹ [SoCalGas Form PHMSA F 7100.1-1 \(2016\)](#).
² [SDG&E Form PHMSA F 7100.1-1 \(2016\)](#).
³ [SoCalGas Form PHMSA F 7100-2-1 \(2016\)](#).
⁴ [SDG&E Form PHMSA F 7100.2-1 \(2016\)](#).
⁵ Moreno Valley compressor station is owned by SDG&E but located in SoCalGas distribution service area.



**Company Operations Standard
Gas Standard
Gas Operations & System Integrity**

Public Awareness Plan	SCG:	PA-1
------------------------------	-------------	-------------

Storage Fields: SoCalGas (4): Aliso Canyon, Goleta, Honor Rancho, and Playa Del Rey. Montebello storage field is no longer operating but still has some DOT equipment.

Unique Assets: Borrego Springs Liquefied Natural Gas (LNG) facility

1.1. OBJECTIVES

Compliance with 49 CFR 192.616, Public Awareness, which has the following requirements:

- Operator must follow the general program recommendations, including baseline and supplemental requirements of API RP 1162, 1st edition, unless the operator provides justification in its program or procedural manual as to why compliance with all or certain provisions of the recommended practice is not practicable and not necessary for safety.
- The program must include provisions to educate the public, appropriate government organizations, and persons engaged in excavation activities on the following:
 - Use of One-Call notification;
 - Possible hazards associated with unintended releases from a gas pipeline facility;
 - Physical indications a leak has occurred;
 - Steps that should be taken for public safety in the event of a gas release, and
 - Procedures for reporting such an event
- The program must include activities to advise affected municipalities, school districts, businesses and residents of pipeline facility locations.
- The program and the media must be as comprehensive as necessary to reach all areas in which an operator transports gas.
- The program must be conducted in English and in other languages commonly understood by a significant⁶ number and concentration of the non-English speaking population in the operator’s area consistent with Customer Communication policies.
- The program documentation and evaluation results must be available for periodic review by appropriate regulatory officials.

⁶ See Appendix C



**Company Operations Standard
Gas Standard
Gas Operations & System Integrity**

Public Awareness Plan	SCG:	PA-1
------------------------------	-------------	-------------

- Public Awareness of Pipelines – Ensure understanding of the role of pipelines in transporting energy. (A more informed public should contribute to reducing the likelihood and potential impact of pipeline emergencies and releases.)
- Prevention & Response – Help the public understand the steps to take to prevent and respond to pipeline emergencies. (Response refers to the objective of communicating to the public, the appropriate steps to take in the event of a pipeline dig-in, gas release or gas emergency.)
- Reduce occurrences of pipeline emergencies caused by third-party damage through awareness of safe excavation and the use of the One-Call system.

Compliance with 49 CFR 192.12 and API RP 1171, which has the following requirement:

- Operator should coordinate with existing pipeline public awareness plans where possible to address storage-specific communications that may include information such as well setback limits, encroachment and land use policies, or other information that could affect storage well or reservoir integrity.

Compliance with California Public Utilities Code Section 956.5, which has the following requirement:

- Owners and operators of intrastate transmission and distribution lines, at least once each calendar year, shall meet with each local fire department having fire suppression responsibilities in the area where those lines are located to discuss and review contingency plans for emergencies involving the intrastate transmission and distribution lines within the jurisdiction of the local fire department.

2. Management Commitment to Achieving Effective Public Awareness

The Senior Vice President – Gas Engineering & District Operations, is the lead executive responsible for endorsing and providing the necessary resources for the Company’s Public Awareness Program to achieve its goals and objectives. The Public Awareness Program Manager is responsible for briefing the vice president on an annual basis.

Guiding Principles:

- At SoCalGas and SDG&E, the safety of customers, employees and communities has been and will continue to be a top priority. An effective public communication and awareness program is an essential element of our overall safety program.



A Sempra Energy utility

Company Operations Standard Gas Standard Gas Operations & System Integrity

Public Awareness Plan	SCG:	PA-1
------------------------------	-------------	-------------

- SoCalGas and SDG&E have a continuing awareness program to inform and educate its customers, affected public, appropriate public officials, and persons engaged in excavation-related activities on the prevention and recognition of gas pipeline emergencies. This program also includes the proper process for reporting an incident to SoCalGas or SDG&E and the appropriate public officials including first responders.
- The program and the media used will be as comprehensive as necessary to reach all areas in the service territory in which the Company transports natural gas and where Company facilities exist (e.g., pipelines, storage fields, compressor stations).
- While the implementation of this program occurs at all levels of our organization, support from management is critical to the success of the public awareness program. The management is committed to provide support through active participation, resources, and funding for the development, implementation, management and continues improvement of its public awareness program.

The executive sponsor provides further affirmation of his Public Awareness Program support by his signature which is kept in **Appendix O**.



**Company Operations Standard
Gas Standard
Gas Operations & System Integrity**

Public Awareness Plan	SCG:	PA-1
------------------------------	-------------	-------------

3. Roles and Responsibilities

Key Personnel:

Senior Vice President of Gas Engineering & District Operations

- Provide support of the Public Awareness Program (PAP) by providing sufficient resources (personnel & financial) to implement an effective and successful program.
- Executive champion and approver for major changes to the program.

Public Awareness Program Manager, Gas System Integrity Staff & Programs

Gas System Integrity Staff & Programs organization is responsible for administering SoCalGas’ and SDG&E’s Public Awareness Program and has appointed a Public Awareness Program Manager (PAPM). This program manager is also known as the Public Awareness Administrator (PAA). The following are the specific responsibilities of the PAA:

- Tracks and interprets the development and promulgation of applicable federal regulations and incorporates pipeline integrity communication requirements from the Pipeline Integrity Plan into the program to ensure the plan meets 49 CFR 192.616.
- Tracks and verifies through an annual audit to ensure the program is being implemented as planned and records are being maintained.
- Works with the **Public Awareness Team** (described below) to implement communication programs and evaluate the effectiveness of the overall program, including coordinating the effectiveness surveys for each targeted audience, evaluating the results and implementing any required changes to ensure the program meets its objectives.
- Develops questionnaire for effectiveness survey to meet Section 4 (Program Evaluation & Continuous Improvement (Effectiveness) in the PHMSA Form 21 (PAP Effectiveness Inspection) for recall, understanding and behavior.
- Reviews and approves all Public Awareness communications.
- Reviews damage results and trends with **Integrity Management and Gas Operations Staff and Technical Services teams**.
- Evaluates trends and recommendation in effectiveness measurement reports. Makes modifications to the communication strategy such as changing the delivery or message contents to increase the level of recall or comprehensions.
- Annually determines if HCA cities have been changed. If HCA cities have changed, communicates that information to **Regional Public Affairs**.
- Annually determines which languages in addition to English should be communicated and how to reach this population. (Refer to **Appendix B**).



**Company Operations Standard
Gas Standard
Gas Operations & System Integrity**

Public Awareness Plan	SCG:	PA-1
------------------------------	-------------	-------------

- Provides an update report and/ or briefing annually to Executive Sponsor to review results of effectiveness studies and trends, changes to the program, regulatory trends and the resources needed in the future.
- Updates the Public Awareness Plan and effectively manages resources.
- Maintains active membership in state or national Public Awareness organizations to keep track of regulatory trends, leverage the skills and experience from other pipeline operators. Provides support to these organization as needed.

Public Awareness Team

The public awareness team is an intra-company group consisting of representatives of the key departments that are responsible for communications with the targeted audiences and are involved in the development and implementation of public awareness communications.

Table 1 summarizes the listing of the public awareness audiences and the responsible organizations.

See **Appendix A** for a complete listing of departments that support this program.**TABLE 1**

Audience and Lead Owner/Department

Audience	Lead Owner/Department	
	SoCalGas	SDG&E
Public Officials	Regional Public Affairs	Regional Public Affairs
Customers	Customer Engagement and Insights	Marketing, Research and Analytics
Affected public near DOT-T pipeline ROW, storage field and compressor stations	Customer Engagement and Insights, Storage Operation /Reservoir Engineering/Storage Risk Controls Managers	Marketing, Research and Analytics
Affected public inside DST	Customer Engagement and Insights	Marketing, Research and Analytics, Media Communications
Emergency County Coordinators	Emergency Services	Emergency Services and Business Continuity
Emergency Responders	Emergency Services	Gas Operations, Gas Distribution and Customer Services
Excavators, farmers, land developers	Gas Operations Services, Customer Engagement and Insights	Gas Operations Services, Marketing, Research and Analytics



Attachment R
**Company Operations Standard
 Gas Standard
 Gas Operations & System Integrity**

Public Awareness Plan	SCG:	PA-1
------------------------------	-------------	-------------

Audience	Lead Owner/Department	
	SoCalGas	SDG&E
Schools, colleges and universities	PAA, Regional Public Affairs	PAA, Regional Public Affairs
Employees	Media and Employee Communications	Media and Employee Communications

4. Overall Communications Strategy

SoCalGas and SDG&E operate one public awareness program to cover all their gas pipelines, storage wells and reservoirs, and associated facilities.

The following plan addresses the communications requirements of 49 CFR 192.12 and 192.616, Public Awareness, including the general program recommendations noted in the first edition of API RP 1162 and API RP 1171. Where there may be variances, the rationale is provided as to why certain provisions of the recommended practice are not practicable and/ or provide very limited value to safety.

Both companies will also include in its Public Awareness Program provisions for familiarizing its employees with its public education objectives. Information and material used by the Company will be made available to employees who can promote gas pipeline and storage wells and reservoirs education in their day-to-day activities as well as in their communities.

Departments that are part of the Public Awareness Team (PAT) that have various methods and modes to transmit Public Awareness materials will follow the documentation requirements as listed in sections 7.1 – 7.9 and **Appendix J**.

In addition, both companies may include pipeline, storage wells and reservoirs public awareness messages, as applicable, in other communications as the opportunity arises.

5. Identification of Stakeholder Audiences

The stakeholder audiences are described in **Table 2**. The required message types to these stakeholders are shown in **Table 3**.



A Sempra Energy utility

**Company Operations Standard
Gas Standard
Gas Operations & System Integrity**

Public Awareness Plan	SCG:	PA-1
------------------------------	-------------	-------------

The stakeholders listed below will be identified and/ or updated by the responsible party prior to each scheduled communication.

**TABLE 2
Identification of Stakeholder Audiences**

Stakeholder Group	Definition	Methods to Identify Stakeholder Group
Customers	Residents and commercial/industrial businesses, which reside within the service territory, and receive regular or paperless billing from SDG&E or SoCalGas.	Customer and paperless billing customer lists from Internal Billing Files.
Affected Public ⁷ Within Distribution Service Territory	Customers and non-customer residents, commercial/industrial businesses, within the distribution service territory.	This audience will not be individually identified.
Affected Public along pipeline ROW <i>inside</i> DST	Customers and non-customer residents, businesses, and places of public gathering ⁸ located along DOT pipelines (within the greater distance calculated for the high consequence area (HCA) buffer zone and 660 ft. on both sides of the pipeline) inside Company's service area.	The PAA in conjunction with the Geographic Information System (GIS) group identifies the distribution service area, DOT-T pipeline path, and the buffer zone of 660 feet or greater depending on the Potential Impact Radius (PIR).
Affected Public along pipeline ROW <i>outside</i> ¹² DST	Non-customer residents, commercial/ industrial businesses, and other places of public gathering ⁸ located along DOT pipelines (within the greater distance calculated for the high consequence area (HCA) buffer zone and 660 ft. on both sides of the pipeline) outside Company's service area.	The PAA in conjunction with the GIS group identifies the distribution service area, DOT-T pipeline path, and the buffer zone of 660 or greater depending on the PIR.
Affected Public Near Compressor Stations	Residents, businesses, and other places of public gathering ⁸ located within 660 ft. (measured from property lines to the nearest DOT equipment within 13 compressor stations (Adelanto, Blythe,	The GIS group under the direction of the PAA identifies the buffer zone around the compressor stations DOT equipment.

⁷All electric customers of SDG&E are not included in this category. They are considered Company customers since they receive the same public awareness messages as do gas customers (e.g., bill inserts).

⁸Places of gathering include: schools, places of worship, hospitals and other medical facilities, prisons, parks and recreation areas, day-care facilities



A Semptra Energy utility

Attachment R
**Company Operations Standard
 Gas Standard
 Gas Operations & System Integrity**

Public Awareness Plan	SCG:	PA-1
------------------------------	-------------	-------------

Stakeholder Group	Definition	Methods to Identify Stakeholder Group
	Cactus City, Desert Center, Kelso, <i>Moreno Station</i> ⁹ , North Needles, Newberry Springs, <i>Rainbow Station</i> ⁹ , South Needles, Sylmar, Ventura and Wheeler Ridge).	
Affected Public Near Storage Fields	<p>Residents, businesses, and other places of public gathering⁸ located within 660 ft. (measured from property lines to the nearest DOT equipment within the storage facility (Aliso Canyon, Goleta, Honor Rancho, and Playa del Rey) and located in and around the storage fields boundaries including the storage buffer zones. Residents near former storage field, Montebello will also be included. Communications may expand beyond this distance if Public Affairs and/or Storage Operations believe it is warranted and appropriate.</p> <p>Public officials and emergency officials with jurisdiction of locations within 660 ft. (measured from property lines to the nearest DOT equipment within the storage facility and in and around the storage fields boundaries including the storage buffer zones.</p> <p><i>There are no SDG&E-owned storage fields.</i></p>	<p>The GIS group under the direction of the PAA and the Storage Reservoir Engineering Manager identifies the storage buffer zone (see SIMP.A. for definition) around the storage field DOT equipment.</p>
School Officials ¹⁰	<p>Elementary, high school, university and community college superintendents and chancellors in the 13 counties where the company operates. Specifically, we will target:</p> <ul style="list-style-type: none"> • School Districts (K-12) • Community college districts • Colleges and Universities 	<ul style="list-style-type: none"> • School District Officials are identified using a school contact database for schools provided by the California Department of Education that is publicly available on their website at http://www.cde.ca.gov/re/sd/. Contact information associated with the district contact for each school is extracted and used to create a contact list. • Community college district officials are

⁹ SDGE has two compressor stations at Moreno and Rainbow. However, the Moreno facility is in SoCalGas distribution service area and the affected public in this area will receive letters with the SoCalGas logo to facilitate recognition.

¹⁰ Schools along the company's ROW are also targeted as part of the Affected Public along ROW commutations.



A Sempra Energy utility

Company Operations Standard Gas Standard Gas Operations & System Integrity

Public Awareness Plan	SCG:	PA-1
------------------------------	-------------	-------------

Stakeholder Group	Definition	Methods to Identify Stakeholder Group
		<p>identified using a database provided by the California Community Colleges Chancellor's Office that is publicly available on their website at http://californiacommunitycolleges.cccco.edu/Districts.aspx</p> <ul style="list-style-type: none"> Public College and University Officials are identified through publicly available sources Supplemental: Pipeline Association for Public Awareness (PAPA) identifies school districts in counties in which the Company operates¹⁴. Or use of a designated third-party contractor to identify audience
Emergency Officials	<p>County emergency response coordinators in the 13¹¹ counties located within our distribution service territory as well as areas outside¹² our service territories where we have transmission pipelines and/or compressor stations.</p> <ul style="list-style-type: none"> SoCalGas Counties (12): Fresno, Imperial, Kern, Kings, Los Angeles, Orange, <u>Riverside</u>, San Bernardino, Santa Barbara, San Luis Obispo, Tulare, Ventura SDGE Counties (2): <u>Riverside</u> and San Diego 	<p>SoCalGas Emergency Services/ SDGE Emergency Services & Business Continuity and SDG&E Gas Operations identify Emergency Response Coordinators.</p> <p>Supplemental: PAPA identifies emergency responders in counties in which the Company operates¹³.</p>
Public Officials	<p>HCA and Non-HCA city and county managers, local elected officials whose jurisdiction includes an underground storage field or compressor station have been identified as the target audience for required communication with local public officials.</p>	<p>Regional Public Affairs team identifies officials based on role in conjunction with the PAA.</p> <p>Supplemental: PAPA identifies public officials in counties in which the Company operates¹⁴.</p>
Excavators, Land Developers	<p>Businesses, such as contractors and land developers, which could be involved in any</p>	<p>NAICS/SIC Codes and One-Call membership lists/meetings will be used for reaching this</p>

¹¹ 13 county emergency response coordinators with 1 shared. Riverside emergency response coordinator is the shared coordinator.

¹² SDG&E has no transmission lines outside their service territory, so this audience does not exist for SDG&E.

¹³ PAPA's Emergency Officials program start year: 2007

¹⁴ PAPA's Public Officials program start year: 2013; School districts added to the mailing list in 2015.



A Sempra Energy utility

**Company Operations Standard
Gas Standard
Gas Operations & System Integrity**

Public Awareness Plan	SCG:	PA-1
------------------------------	-------------	-------------

Stakeholder Group	Definition	Methods to Identify Stakeholder Group
	form of excavation activity in the service territory, and over or adjacent to our pipeline facilities outside of the service territory.	audience. Excavators and land developers with applicable codes in the counties where we have facilities will be targeted. Supplemental: PAPA identifies excavators in counties in which the Company operates ¹⁵ .
Business entities involved in exploration or production	Businesses such as water, oil or other mineral producers which could be involved in any form of drilling activities within the storage boundaries and storage buffer zones.	Storage Operations identifies these businesses through conducting patrols and reviewing permits issued by DOGGR.
Farmers	Farmers comprise of customers and non-customers within our local natural gas distribution company (LDC).	Farmer Subsidy lists and/or SIC/NAICS code.
Company Employees	Employees of SoCalGas and SDG&E who can support the Public Awareness program.	Internal employee lists.

6. Message Content

**TABLE 3
Message Content**

Stakeholder Group	Messages
Customers	<i>Baseline (Frequency - 2x/ year)</i> 1) Pipeline purpose & reliability 2) Awareness of hazards and prevention measures undertaken by the operator 3) Damage prevention awareness 4) Leak recognition and response 5) How to get additional information

¹⁵ PAPA's Excavator program start year: 2015



A Sempra Energy utility

Company Operations Standard Gas Standard Gas Operations & System Integrity

Public Awareness Plan	SCG:	PA-1
------------------------------	-------------	-------------

Stakeholder Group	Messages
	<p><u>Supplemental</u> (<i>Frequency – at least 1x/ year</i>)</p> <ol style="list-style-type: none"> 6) Pipeline location info, including pipeline markers description and purpose 7) One-Call requirements 8) Integrity Management Program summary for HCA 9) ROW Encroachment Prevention 10) Availability of NPMS 11) Odor fade 12) Maintain your gas lines 13) Major maintenance/ construction activity, as needed
Affected Public ⁷ Within Distribution Service Territory	<p>SoCalGas: This audience will not be individually identified.</p> <p>SDG&E: Same as for customers</p>
<ul style="list-style-type: none"> • Affected Public along pipeline ROW <i>inside/ outside</i> DST • Schools¹⁰ 	<p><u>Baseline</u> (<i>Frequency – every two years</i>)</p> <ol style="list-style-type: none"> 1) Pipeline purpose & reliability 2) Awareness of hazards and prevention measures undertaken by the operator 3) Damage prevention awareness 4) Leak recognition and response 5) How to get additional information 6) Pipeline location info, including pipeline markers description and purpose 7) One-Call requirements 8) Availability of NPMS <p><u>Supplemental</u> (<i>Frequency – every two years</i>)</p> <ol style="list-style-type: none"> 9) Integrity Management Program information and/ or overview 10) ROW encroachment prevention 11) Odor fade 12) Major maintenance/ construction activity, as needed
Affected Public Near Compressor Stations	<p><u>Supplemental</u> (<i>Frequency – every two years</i>)</p> <ol style="list-style-type: none"> 1) Incident response notification and/ or evacuation measures (if appropriate) 2) Facility purpose, location and description 3) Integrity management program summary 4) Assurance security has been considered
Affected Public Near Storage Fields	<p><u>Supplemental</u> (<i>Frequency – every two years</i>)</p> <ol style="list-style-type: none"> 1) Storage purpose & reliability 2) Incident response notification and/ or evacuation measures (if appropriate) 3) Facility purpose, location and description 4) Integrity management program summary 5) Assurance security has been considered
Emergency Officials	<p><u>Baseline</u> (<i>Frequency – annually</i>)</p> <ol style="list-style-type: none"> 1) Pipeline purpose & reliability



A Sempra Energy utility

**Company Operations Standard
Gas Standard
Gas Operations & System Integrity**

Public Awareness Plan	SCG:	PA-1
------------------------------	-------------	-------------

Stakeholder Group	Messages
	2) Awareness of hazards and prevention measures undertaken by the operator 3) Emergency preparedness communications and contacts 4) Potential hazards of product transported 5) Pipeline location information and availability of NPMS 6) Integrity management program overview 7) How to get additional information, including how to access company’s emergency plan 8) One-Call requirements <u>Supplemental (Frequency – as needed)</u> 9) Any planned major maintenance/ construction activity, as needed 10) Odor fade
Public Officials	<u>Baseline (Frequency – annually for HCA and every three years for non-HCA)</u> 1) Pipeline purpose & reliability 2) Awareness of hazards and prevention measures undertaken by the operator 3) Emergency preparedness communications 4) Pipeline location information and availability of NPMS 5) Integrity management program overview 6) One-Call requirements 7) How to get additional information <u>Supplemental (Frequency – annually for HCA and every three years for non-HCA)</u> 8) Any planned major maintenance/ construction activity, as needed 9) HCA Designation (if applicable) 10) ROW Encroachment Prevention 11) Odor fade
Excavators/ Contractors/	<u>Baseline (Frequency – annually)</u> 1) Pipeline purpose & reliability 2) Awareness of hazards and prevention measures undertaken 3) Leak recognition and response 4) Damage prevention awareness 5) How to get additional information 6) Pipeline location information and availability of NPMS 7) One-Call requirements, including that it’s the law in California <u>Supplemental (Frequency – annually)</u> 8) Odor fade



A Sempra Energy utility

**Company Operations Standard
Gas Standard
Gas Operations & System Integrity**

Public Awareness Plan	SCG:	PA-1
------------------------------	-------------	-------------

Stakeholder Group	Messages
Land Developers/ Farmers	<p><u>Supplemental</u> (Frequency – every two years)</p> <ol style="list-style-type: none"> 1) Pipeline purpose & reliability 2) Awareness of hazards and prevention measures undertaken 3) Leak recognition and response 4) Damage prevention awareness 5) How to get additional information 6) Pipeline location information and availability of NPMS 7) One-Call requirements, including that it's the law in California 8) Row encroachment prevention 9) Odor fade
Business entities involved in exploration or production	<p><u>Supplemental</u> (Frequency – annually)</p> <ol style="list-style-type: none"> 1) Pipeline purpose & reliability 2) Awareness of hazards and prevention measures undertaken 3) Leak recognition and response 4) Damage prevention awareness 5) How to get additional information 6) Pipeline location information and availability of NPMS 7) One-Call requirements, including that it's the law in California 8) Row encroachment prevention 9) Odor fade 10) Well set back limits 11) Encroachment and land use policy 12) Gas Storage purpose & reliability
One-Call Center	<p><u>Baseline</u> (Frequency –as needed)</p> <p>Provide updated pipeline and other information per USA One-Call Center requirements. Participate in excavator meetings.</p>
Company Employees (management & appropriate personnel)	<p><u>Supplemental</u> (Frequency – as needed)</p> <ol style="list-style-type: none"> 1) Pipeline purpose & reliability 2) Awareness of hazards and prevention measures undertaken by the operator 3) Damage prevention awareness 4) Leak recognition and response 5) How to get additional information

Communications Summary

See **Appendix K - Communications Required by Targeted Audience** for a summary of the message types, delivery methods, and the frequencies that will be provided to each targeted audience identified in API RP 1162. This table also provides the associated departmental responsibilities for these audiences.



Attachment R
**Company Operations Standard
 Gas Standard
 Gas Operations & System Integrity**

Public Awareness Plan	SCG:	PA-1
------------------------------	-------------	-------------

All the baseline and supplemental message types and frequencies listed in Tables 2-1 and 2-2 of API RP 1162 will be followed until effectiveness surveys indicate that changes are necessary. The suggested delivery methods shown in the API RP 1162 tables provide options for both baseline and supplemental activities. The Company has selected the most effective baseline and supplemental delivery method for each audience.

All communications are approved by the PAA. Legal reviews all new and materially modified communications.

See Appendix L - **Method of Communication and Documentation** for details on the types of records kept in an internal company network drive and/or a centralized web-based tracking system to document the communication made to each audience.

7. Summary and Rationale of Planned Communications by Audience

7.1. AFFECTED PUBLIC: CUSTOMERS

Group Responsibility:

SoCalGas Customer Engagement and Insights (CE&I) and SDG&E Marketing, Research and Analytics (MR&A) (aka “Communications”) teams have the lead responsibility with support from the PAA.

Specifically, these groups are responsible for identifying and/or updating customer contact lists (mail/ email) before each communication campaign, reviewing and/ or revising customer communications, obtaining legal and branding approvals and delivering communications to the required stakeholders.

Definition of Target Audience: see **Table 2**

Methods to Identify Stakeholder Group: see **Table 2**

Messages Content: see **Table 3**

Delivery Methods/ Materials, Message Frequency, Records and Responsible Party:

Delivery Methods/ Materials	Frequency	Records	Responsible Party
Baseline Communications			
Bill stuffer (English/ Spanish)	2x/ year	Copy of bill stuffer.	CE&I/ MR&A
Supplemental Communications			



A Sempra Energy utility

Company Operations Standard Gas Standard Gas Operations & System Integrity

Public Awareness Plan	SCG:	PA-1
------------------------------	-------------	-------------

Delivery Methods/ Materials	Frequency	Records	Responsible Party
<p>Email for paperless customers (in English, includes link to bill stuffer in English/Spanish)</p> <p><i>Note: all paperless customers can access bill stuffers at any time through the link on My Account landing page. The link is provided with each paperless bill.</i></p>	2x/ year	Copy of email, proof of sending.	CE&I/ MR&A
<p>Major Projects and other Construction/ Maintenance Alerts – Public Affairs, Field Supervisors or Project Managers select the most effective way to contact the affective public prior to any significant maintenance or construction activity.</p>	As needed	Letters or other communication vehicles as determined by major projects leads. ¹⁶	Regional Public Affairs/ Field Supervisors/ Project Managers
<p>New Customers - New customers at time of gas service turn on, receive a copy of the Company’s Home Energy Guide with gas safety messages from a Service Technician; and with the new customer’s first bill, they receive an inserted gas safety pamphlet (SoCalGas) or bill onsert (SDG&E).</p> <p>These notifications inform new customers that if they have buried piping between the gas meter and the building, it is not maintained by SDG&E or SoCalGas.</p>	Once during service turn on	<p>Latest copy of the Company’s Home Energy Guide can be found on : SoCalGas website and on SDG&E website</p> <p>SoCalGas Bill inserts : All bill inserts for the last five years are available on the SoCalGas website.</p> <p>SDG&E bill inserts: All bill inserts for the last five years are available on the SDG&E website.</p>	CE&I/ MR&A
<p>Social Media: Safety messages on Facebook and Twitter</p>	On-going	Copy of Facebook/ Twitter messages.	CE&I/ MR&A
<p>Public Relation News release</p>	On-going	Copy of news-releases.	Media Communication
<p>USA 811 bumper stickers on company existing and new fleet vehicles</p>	On-going	Email confirmation from Fleet Services.	Fleet Services

¹⁶ Groups that oversee company’s major projects are responsible for creating, delivering and keeping track of communications with the affected public and public/ emergency officials.



A Sempra Energy utility

Company Operations Standard Gas Standard Gas Operations & System Integrity

Public Awareness Plan	SCG:	PA-1
------------------------------	-------------	-------------

Delivery Methods/ Materials	Frequency	Records	Responsible Party
SoCalGas: 811 message (English/ Spanish) on the Interactive Voice Response (IVR) system when customers are on-hold while waiting to speak to a representative.	On-going	Email confirmation from Customer Contact Centers.	Customer Contact Center
Website – SoCalGas and SDG&E Safety websites with relevant safety and damage prevention information.	On-going	n/a	CE&I/ MR&A
Local Events: utility personnel will communicate pipeline safety messages during local events. Educational items: brochures, scratch and sniff natural gas cards and other give-away items containing the company’s emergency contact information or USA information to be distributed during local events.	As needed	Confirmation of participation (e.g., invitation, email, etc.), photos of booth, number/ type of distributed collateral materials.	Regional Public Affairs/ CE&I/ MR&A
Asian languages: Advertising campaign in Asian languages - Ethnic/community print and/ or online ads. Brochures in Asian languages that can be distributed at community events and available on Company’s websites. <i>See Appendix C. Other language provided for instructions on determination of Asian languages.</i>	Annually	Copy of communications.	CE&I/ MR&A
SoCalGas: Sewer lateral safety brochure for Plumbing Contractors (English/ Spanish) which includes gas safety messages. SDG&E: None. SDG&E Sewer Lateral Inspection Program (SLIP) was completed in December 2012	Annually	Copy of brochure, declaration of mailing and mailing list.	Gas Operations
SoCalGas: Regional Branch Offices display and distribute public awareness safety brochure in branch offices throughout service area.	On-going	Confirmation email from the Branch Office.	Regional Branch offices

Tracking:

The records outlined above will be submitted to the PAA by the responsible party and kept on an internal company network drive and/or a centralized web-based tracking system for at least 5 years.

Program Evaluation & Improvement:

Communications will be evaluated **every four years** at a minimum using a mail survey in English and Spanish or other formal survey instruments as determined by our Communications Research group, with a target of at least 300 responses to obtain an acceptable margin of error



Company Operations Standard Gas Standard Gas Operations & System Integrity

Public Awareness Plan	SCG:	PA-1
------------------------------	-------------	-------------

(See **Appendix D**). Based on survey results, messages, delivery methods and materials may be revised.

7.2. AFFECTED PUBLIC WITHIN DISTRIBUTION SERVICE TERRITORIES

Group Responsibility:

Media Communications as well as **SoCalGas CE&I/ SDG&E MR&A** have the lead responsibility with support from the **PAA**.

Definition of Target Audience:

SoCalGas: This audience will not be individually identified.

Within SoCalGas service area, we have about 90% market share, which means 10% of homes and businesses do not receive our gas service and can't be communicated through the bill inserts or emails. It is not efficient to communicate to non-customers specifically, so we use non-paid media and paid media to reach all affected public in our service area.

Examples of non-paid media are news release and local cable TV interviews. Examples of paid media are freeway billboards, movie theatre ads, search engine ads (local results), newspapers, and ads in community magazines. A special paid-media campaign in Asian languages is also released annually.

SDG&E: Other residents (non-gas customers) living within SDG&E's service area are electric customers, therefore messages delivered through a bill insert will have 100% coverage of the messages. Non-paid media efforts will be attempted in SDG&E's service area to help increase the penetration of the message.

Messages to be considered:

- Pipeline Purpose & Reliability
- Awareness of Hazards and Prevention Measures Undertaken
- Damage Prevention Awareness
- Leak Recognition and Response
- How to Get Additional Information
- Odor Fade

Message Delivery Frequency:

Frequency and message type will be determined by the PAA, Media Communications and SoCalGas CE&I/ SDG&E MR&A annually.



Company Operations Standard Gas Standard Gas Operations & System Integrity

Public Awareness Plan	SCG:	PA-1
------------------------------	-------------	-------------

Delivery methods:

- Annual press releases, other non-paid media efforts such as Public Service Announcements and articles in English, Spanish, and Asian languages.
- Paid advertising campaign in Asian languages.
 - Determination of Asian languages will be based on the annual, if available, results from American Community Study Survey for adults who speak another language at home and speak English “less than very well” provided by the U.S. Census. Ethnic/community print ads would most likely be used to reach this Asian segment.
- Brochures in English, Spanish and Asian languages that could be distributed at community events, meetings, via direct mail or other means.
- A dedicated section on Company’s website with safety messages.

Tracking:

Non-paid media relations efforts will be tracked via a news clipping service for English & Spanish languages. The records will be kept on an internal company network drive and/or a centralized web-based tracking system for at least 5 years.

Program Evaluation & Improvement:

Communications activities will be evaluated **every four years** at a minimum using formal survey instruments as determined by our Communications Research group, with a target of at least 300 responses to obtain an acceptable margin of error. SDG&E will include a screening question in their “customer” research to obtain feedback from their non-gas users. Based on the survey results, messages, delivery methods and materials may be revised.

7.3. AFFECTED PUBLIC ALONG TRANSMISSION LINES INSIDE AND OUTSIDE OF DISTRIBUTION SERVICE TERRITORY

Group Responsibility:

The PAA has the lead responsibility with support from **SoCalGas CE&I/ SDG&E MR&A, Transmission, and Geographic Information System (GIS) team.**

Prior to each mailing, the GIS team updates/ reviews shape files for the affected public along transmission lines and provides the updated files to the PAA. The PAA provides the shape files to a designated third-party vendor for the extraction of a mailing/contact list.

The PAA confirms that the vendor flags whether the affected public is a resident, business, public/ emergency official or school, if possible. Refer to **Appendix E** for additional information on the procedure to develop the shape files.



Attachment R
**Company Operations Standard
 Gas Standard
 Gas Operations & System Integrity**

Public Awareness Plan	SCG:	PA-1
------------------------------	-------------	-------------

The PAA provides the mailing list to the SoCalGas CE&I and SDG&E MR&A teams for mailing. The SoCalGas CE&I and SDG&E MR&A review and/ or revise communications, obtain legal and branding approvals and deliver communications to the required stakeholders.

Definition of Target Audience: see **Table 2**

Methods to Identify Stakeholder Group: see **Table 2**

Messages Content: see **Table 3**

Delivery Methods/ Materials, Message Frequency, Records and Responsible Party:

Delivery Methods/ Materials	Frequency	Records	Responsible Party
Baseline Communications			
Direct Mail: Letter and/or Brochure	Every two years	Copy of a mailing list, letter/ brochure, envelope, proof of mailing, GIS shapes files.	CE&I/ MR&A
Supplemental Communications			
Major Projects and other Construction/ Maintenance Alerts – Public Affairs, Field Supervisors or Project Managers in conjunction with Transmission select the most effective way to contact the affective public prior to any significant maintenance or construction activity.	As needed	Letters or other communication vehicles ¹⁶ .	Regional Public Affairs/ Field Supervisors/ Project Managers

Tracking:

The required records outlined above will be submitted to the PAA by the responsible party and kept on an internal company network drive and/or a centralized web-based tracking system for at least 5 years.

Program Evaluation & Improvement:

Communications will be evaluated **every four years** at a minimum using a mail survey or other formal survey instruments as determined by our Communications Research group, with a target of at least 300 responses to obtain an acceptable margin of error (See **Appendix D**). Based on survey results, messages, delivery methods and materials may be revised.



Attachment R
**Company Operations Standard
 Gas Standard
 Gas Operations & System Integrity**

Public Awareness Plan	SCG:	PA-1
------------------------------	-------------	-------------

7.4. AFFECTED PUBLIC NEAR COMPRESSOR STATIONS AND STORAGE FIELDS

Group Responsibility:

The PAA has the lead responsibility with support from **SoCalGas CE&I/ SDG&E MR&A, Transmission, Storage, and Geographic Information System (GIS) team.**

Prior to each mailing, the GIS team updates/ reviews shape files for the affected public near the Compressor Stations and Storage Fields and provides the updated files to the PAA. The PAA provides the shape files to a designated third-party vendor for the extraction of a mailing/contact list.

The PAA confirms that the vendor flags whether the affected public is a resident, business, public/ emergency official or school, if possible. Refer to **Appendix E** for additional information on the procedure to develop the shape files.

The PAA provides the mailing list to the SoCalGas CE&I and SDG&E MR&A teams for mailing. The SoCalGas CE&I and SDG&E MR&A review and/ or revise communications, obtain legal and branding approvals, and deliver communications to the required stakeholders.

Definition of Target Audience: see **Table 2**

Methods to Identify Stakeholder Group: see **Table 2**

Messages Content: see **Table 3**

Delivery Methods/ Materials, Message Frequency, Records and Responsible Party:

Delivery Methods/ Materials	Frequency	Records	Responsible Party
Supplemental Communications			
Direct Mail: Letter and/or brochure	Every two years	Copy of a mailing list, letter/ brochure, envelope, proof of mailing (including number of pieces mailed and date), GIS shapes files.	CE&I/ MR&A
Other: Natural Gas Storage Facilities In an effort to better update and inform residents and businesses around facilities, SoCalGas includes information about our approach to maintaining safety at	As needed	SoCalGas website	PAA/ Regional Public Affairs/CE&I



A Sempra Energy utility

**Company Operations Standard
Gas Standard
Gas Operations & System Integrity**

Public Awareness Plan	SCG:	PA-1
------------------------------	-------------	-------------

Delivery Methods/ Materials	Frequency	Records	Responsible Party
natural gas storage facilities.			

Tracking:

The required records outlined above will be submitted to the PAA by the responsible party and kept on an internal company network drive and/or a centralized web-based tracking system for at least 5 years.

Program Evaluation & Improvement:

Because of the small sample size, communications will be evaluated **every four years** at a minimum by the Company’s Communications Research group using a *phone survey* to obtain an appropriate margin of error (See **Appendix D**). Based on survey results, messages, delivery methods and materials may be revised.

7.5. UNIQUE ASSET: BORREGO SPRINGS LIQUEFIED NATURAL GAS FACILITY

The Borrego Spring Liquefied Natural Gas (LNG) facility was added to the PAP in 2014.

The LNG is located on the grounds of the Roadrunner Mobile Home Park. Annually, the **SDG&E Gas Technical Services** (Miramar) will provide safety materials about the LNG facility and contact information to the park office. Additionally, the park manager will be invited to attend the Borrego Springs Fire Department meetings with the **SDG&E Gas Technical Services** (Miramar).

Furthermore, the Borrego LNG Facility obtains liquefied natural gas for residential use to the mobile home park from LNG supply vendors. Along with the LNG, the vendor provides a Material Safety Data Sheet (MSDS), which describes important issues such as the physical properties of the LNG, potential hazards associated with handling LNG, and recommended Personal Protective Equipment (PPE). MSDS sheets are in Sections 9.0 of the local station site binder for the Borrego Springs LNG Facility in the SDG&E Operations Document Management System.

The Borrego Springs Fire Department has been provided regular on-site reviews of the facility operations and safety features by the **SDG&E Gas Technical Services** (Miramar) in accordance with the SDG&E Gas [Standard G8210](#), “*Contact with Fire and Police Departments and Public Agencies*”. In the event of a gas emergency within the park, but outside of the LNG facility, the



Attachment R
**Company Operations Standard
 Gas Standard
 Gas Operations & System Integrity**

Public Awareness Plan	SCG:	PA-1
------------------------------	-------------	-------------

Fire Department has the ability and discretion to close the park isolation valve, which is painted red.

Due to the size and remoteness of this facility, we believe that communications outlined above are sufficient to make sure safety of the mobile home park residents in case of an emergency.

7.6. AFFECTED PUBLIC: SCHOOLS

The PAA has the lead responsibility with support from the **SoCalGas CE&I/ SDG&E MR&A teams** and the **GIS team**.

Refer to **Appendix C** for a detailed procedure to obtain the school superintendents contact list. In addition, a designated third party vendor is utilized for the extraction of a mailing/contact list of all K-12 schools, community colleges, colleges and universities in the DST.

The PAA provides the contact list to the SoCalGas CE&I and SDG&E MR&A teams for mailing. The SoCalGas CE&I and SDG&E MR&A review and/ or revise communications, obtain legal and branding approvals, deliver the required communications and provide proof of mailing to the PAA.

Definition of Target Audience: see **Table 2**

Rationale for the audience definition/ identification:

Superintendents/ chancellors of each elementary and high school and community college district and university in the 13 counties where we have facilities are targeted. As with city and county managers, we are targeting this communication to district superintendents and chancellors because they are responsible for communication with both elected officials and district and school/college staff.

Methods to Identify Stakeholder Group: see **Table 2**

Messages Content: see **Table 3**

Delivery Methods/ Materials, Message Frequency, Records and Responsible Party:

Delivery Methods/ Materials	Frequency	Records	Responsible Party
Supplemental Communications			



Attachment R
**Company Operations Standard
 Gas Standard
 Gas Operations & System Integrity**

Public Awareness Plan	SCG:	PA-1
------------------------------	-------------	-------------

Delivery Methods/ Materials	Frequency	Records	Responsible Party
Direct Mail and/ or Email	Every two years	Contact list, copies of communications, proof of sending.	CE&I/ MR&A
Direct Mail (PAPA Public Officials program ¹⁴): printed materials	1x/ year	List of School Districts contacted, copies of communications, and confirmation of mailing.	PAA

Direct mailers to the affected public (e.g., customers, affected public along pipeline ROW inside and outside distribution service territory, near compressor stations and storage fields) will reach schools within the service territory and near the transmission pipelines.

The PAPA mailers ensure the required messages are delivered to all school districts if emails or mailers are not completed during a required year.

Tracking:

The required records outlined above will be submitted to the PAA by the responsible party and kept on an internal company network drive and/or a centralized web-based tracking system for at least 5 years.

Program Evaluations& Improvement:

Schools communications will be evaluated as part of the affected public communications and / or as stand-alone communications **every four years** at a minimum using formal survey instruments as determined by the Company’s Communications Research group. Based on survey results, messages, delivery methods and materials may be revised.

7.7. EMERGENCY OFFICIALS/COUNTY COORDINATORS

Group Responsibility:

SoCalGas Emergency Services and **SDG&E Emergency Services & Business Continuity** teams have the lead responsibility for ensuring communications with Emergency Officials meet the requirements of the public awareness plan.

Specifically, these teams identify and communicate with 13 County Emergency Response Coordinators and provide the supporting records to the PAA.

Definition of Target Audience: see **Table 2**

Methods to Identify Stakeholder Group: see **Table 2**



A Sempra Energy utility

**Company Operations Standard
Gas Standard
Gas Operations & System Integrity**

Public Awareness Plan	SCG:	PA-1
------------------------------	-------------	-------------

Rationale for the audience definition/ identification:

Combined, SoCalGas and SDG&E operate in approximately 243 incorporated cities and 13 counties, all of which have multiple departments and/or individuals who fit the definition and examples of emergency officials provided in API RP 1162.

SoCalGas and SDG&E have identified the County Emergency Response Coordinators as the entity through which we will communicate with emergency officials. These coordinators already have identified emergency officials throughout their jurisdictions and are responsible for communicating with them. Thus, we have identified them as our primary conduit to emergency officials.

By working through the County Emergency Response Coordinators and PAPA, we will be able to ensure that we are communicating with the appropriate individuals and ensure that our communications are consistent across jurisdictions. This communication can be done more effectively and cost-efficiently than if we were to attempt to communicate directly to all emergency officials at all the cities and counties in our service territories. This totals at least a couple thousand.

Messages Content: see **Table 3**

Delivery Methods/ Materials, Message Frequency, Records and Responsible Party:

Delivery Methods/ Materials	Frequency	Records	Responsible Party
Baseline Communications with County Emergency Response Coordinators			
Meeting or/ and	1x/ year	Email confirming the meeting and/ or sign-in sheet, copies of distributed print materials and/ or meeting agenda/ discussed topics (e.g., presentation)	SoCalGas Emergency Services/ SDG&E Emergency Services & Business Continuity
Email		Copy of sent e-mail.	
Supplemental Communications			
Direct Mail (PAPA mailing): print materials	1x/ year	Copy of mailing list, copies of distributed print materials, confirmation of mailing; CASS/ DPV report.	PAA
Major Project and other Construction/ Maintenance Alerts – Public Affairs, Field Supervisors or Project Managers in conjunction with Transmission select the most effective way to contact emergency officials prior to any significant maintenance or construction activity.	As needed	Letters or other communication vehicles ¹⁶	Regional Public Affairs/ Field Supervisors/ Project Managers



Attachment R
**Company Operations Standard
 Gas Standard
 Gas Operations & System Integrity**

Public Awareness Plan	SCG:	PA-1
------------------------------	-------------	-------------

Delivery Methods/ Materials	Frequency	Records	Responsible Party
Meetings with Fire Departments	Annually	Records to be provided by SoCalGas Emergency Services/ SDG&E Emergency Services & Business Continuity upon request.*	SoCalGas Emergency Services/ SDG&E Emergency Services & Business Continuity
Joint Meetings – SoCalGas Transmission Operations will participate in jointly meetings with other pipeline companies for emergency response officials in the High Desert area.	As needed	Records to be provided by SoCalGas Emergency Services upon request.*	Transmission Operations/ SoCalGas Emergency Services
Emergency Drills –when appropriate, field locations should invite local emergency responders to participate in mock emergency drill exercises.	As needed	Records to be provided by SoCalGas Emergency Services/ SDG&E Emergency Services & Business Continuity upon request.*	SoCalGas Emergency Services/ SDG&E Emergency Services & Business Continuity

The PAPA mailers ensure the required messages are delivered to all emergency officials if meetings, emails or mailers are not completed during a year.

Face-to-face meetings or liaison briefings shall be coordinated by Emergency Services and attended by at least one representative from Field Operations. Liaison briefings are training sessions conducted in a classroom environment for Emergency Responders in which information is share through a PowerPoint, video handout and/or props.

Note*: SoCalGas Gas [Standard 183.0030](#) and SDG&E Gas [Standard G8210](#), “*Contact with Fire and Police Departments and Public Agencies*” specify further requirements of the Distribution Regions and Transmission Districts on conducting and documenting contacts with fire and police departments. SoCalGas Emergency Services and SDG&E Emergency Services & Business Continuity and Gas Operations-Public Awareness & Safety Outreach are responsible for ensuring that documented contacts are in compliance with DOT Regulation CFR 192.615(c) and California Public Utilities Commission Code 956.5 and the ultimate record keepers of these communications. The records will be maintained in a centralized web-based data base accessible to the Public Awareness Team, including the PAA, Field Operations and Regional Public Affairs.

Emergency officials whose jurisdictions include Compressor Stations, Underground Storage Fields, and/ or Liquefied Natural Gas facilities are informed about facilities purpose, location



A Sempra Energy utility

Company Operations Standard
Gas Standard
Gas Operations & System Integrity

Table with 3 columns: Public Awareness Plan, SCG:, PA-1

and product stored or transported through the facility, through a biannual direct mail campaign for the affected public near the Compressor Stations, Underground Storage Fields, or Liquefied Natural Gas facilities.

Furthermore, as we communicate to the affected public near our transmission lines, emergency officials near our ROW also receive public awareness brochures by direct mail.

Tracking:

The required records outlined above will be submitted to the PAA by the responsible party and kept on an internal company network drive and/or a centralized web-based tracking system for at least 5 years.

Program Evaluation & Improvement:

A phone survey will be conducted every four years at a minimum with 12 counties for SoCalGas and two counties for SDG&E through the Pipeline Association for Public Awareness. A supplemental internal phone survey will be conducted every four years at a minimum with 13 County Emergency Response Coordinators. Based on survey results, messages, delivery methods and materials may be revised.

See Appendix F for an Overview of Pipeline Association for Public Awareness' (PAPA) Emergency Responder Program.

7.8. LIAISON WITH EMERGENCY RESPONDERS

PAPA's annual communication to emergency responders is delivered by direct mail. The packet of information includes: Pipeline Emergency Response Guidelines booklet with the Emergency Response scenario CD, Pipeline Emergency Contact Directory, Public Officials Newsletter, and a cover letter. The cover letter lists all the resources that are available on the website and includes a solicitation to meet with local pipeline representatives. This section encourages emergency responders to contact pipeline operators in their community for training sessions, mock drills, and additional information. It also contains links to state association websites for the states that are part of PAPA's program.

Furthermore, Distribution/ Transmission/Storage Operations, Regional Public Affairs, SoCalGas Emergency Services and SDG&E Emergency Services & Business Continuity continue to maintain responsibility for communicating with local emergency officials in

17 Supplemental County Emergency Response Coordinators survey was added to this plan in 2014.



**Company Operations Standard
Gas Standard
Gas Operations & System Integrity**

Public Awareness Plan	SCG:	PA-1
------------------------------	-------------	-------------

accordance with **49 CFR 192.615**, Emergency Plan. Additionally, joint emergency response drills are held when requested by emergency response officials as a supplemental effort.

Fire Department

Face-to-face meetings and/or Liaison briefings shall be conducted on a yearly basis with Fire Departments located in the operating service territory and will utilize material provided by SoCalGas Emergency Services or SDG&E Gas Operations – Public Awareness & Safety Outreach. Holding a liaison briefing eliminates the need for a face-to-face meeting. All briefings and meetings but be documented on the appropriate forms and/or cloud-based forms that will upload to a shared SharePoint site accessible to the Public Awareness Team.

Police Department

SoCalGas Emergency Services will also conduct face-to-face meetings and/or liaison briefings on a rotating quarterly basis targeting the Northwest and Southwest Regions, or as requested by the local Police Departments, with a briefing or meeting to occur with each Police Department at least once every three (3) years. SDG&E Gas Operations-Public Awareness & Safety Outreach shall conduct face-to-face meetings and/or liaison briefings on a periodic basis, or as requested by the local Police Departments and/or Public Agency. All briefings and meetings must be documented on the appropriate forms and/or cloud-based forms that will upload to a shared SharePoint site accessible to the Public Awareness Team. The above-mentioned teams are the ultimate record keepers of these communications. The records should be provided to the PAA upon request. (delete once cloud-base form & SharePoint site created)

A key element of the communication with certain stakeholders, especially Emergency Responders, is the Transmission Pipeline Mapping information provided though the National Pipeline Mapping System (NPMS). According to API 1162, section 4.6.2 at minimum the maps must include line size, product and approximate location of the pipe. Due to security concerns, the diameter of pipelines is not provided in NPMS maps. On an as needed basis and when requested, additional information including diameter and pressure for specific sections of pipelines is provided to emergency responders. PHMSA will be evaluating what information should be provided in NPMS maps, which will provide future guidance.

7.9. PUBLIC OFFICIALS

Group Responsibility:

Regional Public Affairs (RPA) team has the lead responsibility for ensuring communications with Public Officials meet the requirements of the public awareness plan.



Attachment R
Company Operations Standard
Gas Standard
Gas Operations & System Integrity

Public Awareness Plan	SCG:	PA-1
------------------------------	-------------	-------------

Specifically, this team identifies and communicates with appropriate public officials and provides the supporting records to the PAA.

The GIS team annually determines if HCA/ Non-HCA cities have been changed. The PAA is responsible for providing the updated HCA/ Non-HCA list to RPA.

Definition of Target Audience: see **Table 2**
Methods to Identify Stakeholder Group: see **Table 2**

Rationale for the audience definition/ identification:

There are 13 counties, approximately 243 incorporated cities and 242 identifiable unincorporated communities in SoCalGas’ and SDG&E’s service territories. Natural gas distribution pipelines traverse through all of these areas. Larger transmission pipelines, underground storage facilities and compressor stations are also located in a number of these counties, cities and communities. Additionally, SoCalGas has transmission pipelines in areas outside of its service territory.

SoCalGas and SDG&E have identified city managers and county managers or chief administrative officers as the primary public officials to inform regarding pipelines, storage wells and reservoirs and related safety activities. City/county managers are responsible for communicating with elected and appointed city officials as well as the city staff. Thus, we have identified the city/county managers as our primary conduit to public officials within their jurisdictions.

By requiring communication with city/county managers, we will be able to track our communications with public officials and ensure that our communications are consistent across jurisdictions.

Although we have 242 identifiable communities in our service territories, most are recognized as distinct geographical areas but don’t have a local government structure. They are represented by city and/or county government. Thus, by communicating with city/country managers, we will be communicating with public officials in those areas.

Messages Content: see **Table 3**

Delivery Methods/ Materials, Message Frequency, Records and Responsible Party:

Delivery Methods/ Materials	Frequency	Records	Responsible Party
Baseline Communications			
Meeting	1x/ year (HCA)	Email confirming the meeting; public official’s name, title and jurisdiction,	RPA/ PAA



A Sempra Energy utility

**Company Operations Standard
Gas Standard
Gas Operations & System Integrity**

Public Awareness Plan	SCG:	PA-1
------------------------------	-------------	-------------

Delivery Methods/ Materials	Frequency	Records	Responsible Party
or Email	1x/ every 3 year (Non-HCA)	meeting agenda/ discussed topics. Copy of e-mail, proof of sending.	
Supplemental Communications			
Direct Mail (PAPA)¹⁴: printed materials		List of Public Officials contacted, copies of communications, and confirmation of mailing, CASS/ DPV report.	PAA

The PAPA mailers ensure the required messages are delivered to all public officials if meetings or emails are not completed during a year.

Public officials whose jurisdictions include Compressor Stations, Underground Storage Fields, and/ or Liquefied Natural Gas facilities are informed about facilities purpose, location and product stored or transported through the facility, through a biannual direct mail campaign for the affected public near the Compressor Stations, Underground Storage Fields, or Liquefied Natural Gas facilities.

Furthermore, as we communicate to the affected public near our transmission lines, public officials near our ROW also receive public awareness brochures by direct mail.

Tracking:

The required records outlined above will be submitted to the PAA by the responsible party and kept on an internal company network drive and/or a centralized web-based tracking system for at least 5 years.

Program Evaluation & Improvement:

A phone survey will be conducted **every four years** at a minimum through PAPA. A supplemental internal phone survey¹⁸ will be conducted every **four years** at a minimum by our Communications Research group. Based on survey results, messages, delivery methods and materials may be revised.

See **Appendix G** for an Overview of Pipeline Association for Public Awareness’ (PAPA) Public Officials Program.

¹⁸ Supplemental County Emergency Response Coordinators survey was added to this plan in 2014.



**Company Operations Standard
Gas Standard
Gas Operations & System Integrity**

Public Awareness Plan	SCG:	PA-1
------------------------------	-------------	-------------

7.10. CONTRACTORS WHO EXCAVATE, FARMERS, AND LAND DEVELOPERS

Group Responsibility:

The **SoCalGas/ SDG&E Gas Operations group** has the lead responsibility to manage safety events jointly with USA North and South. The **SoCalGas CE&I and SDG&E MR&A groups** have the lead responsibility to develop annual direct mail communications with support from the PAA.

Prior to each mailing, the PAA reviews/ updates NAICS/SIC codes. After pulling the codes, a commercially available list is bought with contacts pertaining to the NAICS/SIC codes within counties where the company operates.

The PAA provides the mailing list to the SoCalGas CE&I and SDG&E MR&A teams for mailing. The SoCalGas CE&I and SDG&E MR&A teams review and/ or revise communications, obtain legal and branding approvals, deliver the required communications and provide proof of mailing to the PAA.

In addition to managing safety events jointly with USA North and South, the SoCalGas/ SDG&E Gas Operations group provides *811 USA Call logs* and *Damages per 1,000 USA tickets* to the PAA annually. This team is also responsible for providing grid updates to USA whenever there are changes in the gas pipeline system.

The Claims team identifies and contacts contractors with multiple damages and provides the supporting records to the PAA.

Definition of Target Audience: see **Table 2**

Rationale for the audience definition/ identification:

We've noted farmers in this category as they may or may not be within LDC but perform similar functions as Contractors who excavates and Land Developers and should receive similar messaging on an annual basis.

Methods to Identify Stakeholder Group: see **Table 2**

Messages Content: see **Table 3**



A Sempra Energy utility

**Company Operations Standard
Gas Standard
Gas Operations & System Integrity**

Public Awareness Plan	SCG:	PA-1
------------------------------	-------------	-------------

Delivery Method/ Materials, Message Frequency, Records and Responsible Party:

Delivery Methods/ Materials	Frequency	Records	Responsible Party
Baseline Communications (Excavators/ Contractors)			
Direct mail: letter and/ or brochure (English/ Spanish)	Annually	Copy of mailing list, letter/ brochure, envelope, proof of mailing (including number of pieces mailed and date), NAICS/SIC codes used.	PAA
USA One-Call excavator meetings: Locations are chosen according to the cities where the most dig-ins occurred.	2 meetings per distribution region (SoCalGas: 8 meetings; SDG&E: 2 meetings)	Invitation, agenda, presentation, sign-up sheet.	SoCalGas Gas Operations Services / SDG&E Gas Distribution Field Operations
One-Call centers: the company will maintain membership in the applicable regional One Call centers (USA) where it has operations. As changes in pipeline areas occur, new Thomas Brothers grids are submitted to the One-Call Center to maintain accurate information in the One-Call Center system. Also when the Company has changes to personnel or equipment utilizing One-Call data, the One-Call Center is notified.	Annually	One-call membership.	SoCalGas Gas Operations Services / SDG&E Gas Distribution Field Operations
Supplemental Communications			
Direct Mail (PAPA)¹⁵: printed materials		List of excavators contacted, copies of communications, and confirmation of mailing.	PAA
Land Developers – direct mail: letter and/ or brochure (English/ Spanish)	Every 2 years	Copy of mailing list, letter/ brochure, envelope, proof of mailing (including number of pieces mailed and date), NAICS/SIC codes, C	PAA
Farmers – direct mail: letter and/ or brochure (English/ Spanish)	Annually	Copy of mailing list, letter/ brochure, envelope, proof of mailing (including number of pieces mailed and date), NAICS/SIC codes.	PAA
Contractors with multiple damages - direct mail and/or meeting and/ or email	On-going	Confirmation of contacts.	Claims



A Sempra Energy utility

**Company Operations Standard
Gas Standard
Gas Operations & System Integrity**

Public Awareness Plan	SCG:	PA-1
------------------------------	-------------	-------------

Delivery Methods/ Materials	Frequency	Records	Responsible Party
SoCalGas: “Contractor Safety” web page on SoCalGas website.	On-going	Contractor Safety webpage on SoCalGas website	PAA
SoCalGas: Sponsorship of the World Farm Show in Tulare where farm visitors can view farming safety demonstrations near natural pipelines, receive agricultural safety brochures as well as 811 promotional items at our booth.	As needed	Proof of participation (e.g., invoice, etc.)	PAA

The **PAPA mailers** ensure the required messages are delivered to all excavators if mailings/ meetings/ emails are not completed during a year.

Direct mailers to the affected public (e.g., customers, affected public along pipeline ROW inside and outside distribution service territory, near compressor stations and storage fields) will also reach excavators, farmers and land developers within the service territory and near the transmission pipelines.

Tracking:

The required records outlined above will be submitted to the PAA by the responsible party and kept on an internal company network drive and/or a centralized web-based tracking system –for at least 5 years.

Program Evaluation & Improvement:

Communication will be evaluated **every four years** at a minimum using a mail survey or other formal survey instruments as determined by the Company’s Communications Research group. Based on survey results, messages, delivery methods and materials may be revised.

Monitoring 3rd-party dig-in incidents will be a key in determining changes in this audience’s behavior. The number of incidents will be reviewed to assess whether there is a downward trend. If there are an increased number of incidents, increased public awareness communications will be considered. Damages per 1,000 One-Calls will be tracked. Questionnaires at USA One-Call events/meetings will be considered.

7.11. EMPLOYEES – SUPPLEMENTAL COMMUNICATIONS

Group Responsibility:



Company Operations Standard Gas Standard Gas Operations & System Integrity

Public Awareness Plan	SCG:	PA-1
------------------------------	-------------	-------------

Internal Communications in coordination with the Public Awareness Team.

Definition of Target Audience:

The SoCalGas and SDG&E combined have over 12,000 employees that provide service to more than 21 million consumers in a service territory covering 13 counties.

Rationale

While employees are not listed as a stakeholder group for which communication on pipeline safety is required under API RP 1162, we believe they represent one of our greatest resources in educating customers about pipeline safety as many have daily if not monthly contact with customers. To the extent that employees are themselves aware of pipeline safety, how to recognize a leak and how to respond to a leak, they are better able to serve as company ambassadors on this subject and are generally perceived by the public as a trustworthy source for information on natural gas safety.

For those reasons, we have included them in this public awareness plan. Employee communications will be consistent with communications to LDC Customers.

Messages to be considered:

1. Pipeline purpose and reliability
2. Gas Storage purpose and reliability
3. Awareness of hazards and prevention measures taken
4. Damage prevention awareness
5. Leak recognition and response
6. Odor fade
7. How to get additional information

Message Delivery Frequency:

Frequency and message type will be determined by the PAA and SoCalGas CE&I/ SDG&E MR&A annually.

Delivery Methods to be considered:

Communications with employees may be done using various internal communications tools including, but not limited to, training, GasLines or PowerUp (Intranet web portal for employees of SoCalGas and SDG&E).



Attachment R
**Company Operations Standard
 Gas Standard
 Gas Operations & System Integrity**

Public Awareness Plan	SCG:	PA-1
------------------------------	-------------	-------------

8. Consideration of Relevant Factors

The Company’s Public Awareness Team evaluated where additional supplemental communications should be performed to address Section 6.2 of API RP 1162. The table below describes the relevant factors that were considered in determining the supplemental activities that are currently included in the program.

Factor	Supplemental Activity Rationale
Potential Hazards	All targeted audiences are receiving all the baseline and supplemental messages for potential hazards of natural gas piping and storage systems. The Company will also consider increasing communications where the public’s confidence in pipeline safety is undermined by a high-profile pipeline or gas storage well emergency.
HCA’s	To ensure a higher level of safety in HCAs, the Company has included supplemental messages on the IMP for HCAs in its plan to the following audiences: <ul style="list-style-type: none"> • Customers • Non-Customers and Places of Congregation Along Transmission Lines Outside the Service Territory • Emergency Officials • Residents Near Compressor and Storage Stations • Public Officials in HCAs • Communication to Public Officials in HCAs will be increased to an annual frequency.
Population density	The Company maps will be updated annually. If non-HCA areas become HCAs, then communications will be made annually to Public Officials in these areas.
New Customers	All new customers, including those in newly developed areas, will receive the Home Energy and Safety Guide brochure from the Service Technician – Field Services . All new customers will also receive a notification that they are responsible for maintaining their gas lines with their first bill.
Land Farming Activity	Excavators that are involved in farming activities are included in the annual excavator mailers. Farmers that live along the Transmission Pipelines outside of our service territory will also receive the Company Pipeline Safety Brochure for residents near Company’s transmission pipelines as part of the Affected Public.
3 rd -Party Damage Incidents	Pipeline Safety and Compliance Manager provides annual CPUC 3 rd -party dig-in report to the PAA, including the causes of these incidents and whether Underground Service Alert (USA) One-Call was notified. The PAA will determine the number of dig-ins per 1000 USA tickets to determine trend over time, and analyze why dig-ins continue to occur and what we can do to reduce them. Claims will communicate excavator safety information with contractors



A Sempra Energy utility

Company Operations Standard Gas Standard Gas Operations & System Integrity

Public Awareness Plan	SCG:	PA-1
------------------------------	-------------	-------------

Factor	Supplemental Activity Rationale
	<p>that have caused multiple damages to Company’s facilities. Additionally, the following supplemental messages to excavators are provided:</p> <ul style="list-style-type: none"> • Pipeline Purpose & Reliability • Prevention Measures Taken <p>Customers are also provided the following supplemental messages to reduce the possibility of dig-ins:</p> <ol style="list-style-type: none"> 1. Pipeline Location Information 2. One-Call Requirements 3. ROW Encroachment Prevention 4. Availability of NPMS <p>Also, in addition to the annual excavator mailer, SoCalGas will work closely with USA One-Call to attempt to have two meetings per Distribution Region with excavators for a total of eight annual meetings in SoCalGas service territory. SDG&E will attempt to hold two annual USA One-Call meetings in its service territory.</p> <p>SoCalGas and SDG&E will affix Underground Service Alert (USA) bumper stickers with “Call 811” information on all company existing and new fleet vehicles.</p>
Environmental Considerations	If supplier upset conditions result in contaminated gas, then specific action will be taken and communication will be made with affected parties. Such action and communication will likely be of a short duration and handled outside the broader Public Awareness Program.
Pipeline History in the Area	If a local area is determined to be a significantly larger source of 3 rd -party damage than other areas, the Company will consider enhancing its 3 rd -party damage program in that area.
Specific Local Situations	Along with 3 rd -party damage, if the Company becomes aware of significant maintenance or construction activities in a particular area, consideration will be given to providing public and emergency officials, and residents along the area, pipeline safety communications. The Company will also consider increasing communications where the public’s confidence in pipeline safety is undermined by a high-profile pipeline emergency. Real Estate & Land Services will notify the PAA of increasing ROW encroachment that can be reduced by increased public awareness communications.
Regulatory Requirements	The PAA will be monitoring regulatory changes to the Public Awareness requirements in CFR 49 Part 192 or CPUC GO-112 and incorporate changes into the Plan as appropriate.
Results from Public Awareness Program Evaluations	The Communications Research group conducts survey every four years, or more often as needed, for each targeted audience. The results of these surveys



**Company Operations Standard
Gas Standard
Gas Operations & System Integrity**

Public Awareness Plan	SCG:	PA-1
------------------------------	-------------	-------------

Factor	Supplemental Activity Rationale
	will be reviewed to determine whether the objectives of the program are being met. If the objectives are not met, additional or enhanced communications will be considered.
Major Maintenance and Construction	Regional Public Affairs, Field Supervisors or Project Managers will notify the affected public of major Company maintenance and construction activities.

9. Record Keeping

The company will maintain records of key program elements to demonstrate the level of implementation of the Public Awareness program. Primary documentation will be maintained on an internal company network drive and/or a centralized web-based tracking system. Record keeping will include:

- Lists, records or other documentation of stakeholder communications.
- Copies of materials provided to each stakeholder audience.
- All program evaluations including current results and follow-up actions.
- Program changes

Records will be kept for a period of five years.

10. Program Evaluation and Continuous Improvement

10.1. ANNUAL PROGRAM IMPLEMENTATION AUDIT

A program implementation audit is performed annually by the PAA. The PAA verifies that all scheduled communications have been completed as planned through review/ tracking of submitted documentation. This includes validating that the required messages have been communicated with the required frequencies to all stakeholder audiences through identified delivery channels.

If any major deficiencies are found during the implementation audit, the PAA is responsible for identifying the root causes of the deficiencies and recommending possible solutions. The major audit findings will be summarized and documented in an annual review document (a.k.a. annual senior management report).



Company Operations Standard Gas Standard Gas Operations & System Integrity

Public Awareness Plan	SCG:	PA-1
-----------------------	------	------

Regulatory audits will also count for review.

Furthermore, annually, the PAA should solicit a feedback from the responsible departments/ audience owners (see Table 1) about possible program improvements.

10.2. EFFECTIVENESS EVALUATION

Effectiveness surveys will be in accordance with the Program Evaluation and Improvement Sections shown above for each targeted audience and will be completed **every four years** by the company's Communications Research group.

The company measures stakeholders' **reach** by evaluating recall of communication materials for each stakeholder audience in the mail/email/phone surveys.

The company measures **message comprehension and knowledge** by evaluating results of the mail/email/phone surveys.

The company measures stakeholders' **behavior** through self-reported behavioral data in the mail/email/phone surveys.

The company measures **bottom-line results** by analyzing third-party incidents and One-Call tickets. Data is used by the PAA and/or field representatives to determine if SoCalGas and SDG&E's PAP is contributing to a reduction in the number of pipeline incidents and to identify the need for new or expanded PAP activity to support damage prevention efforts across the two companies.

11. Program Changes

The PAA will analyze the results and findings of effectiveness evaluations and audits and outline major changes, if any, in the annual review document (Annual Senior Management Report).

Specifically, the PAA will

- Review implementation audit results
- Review CPUC and formal internal audits, if any
- Review research conducted for the year, if any
- Review dig-in data (damages)



**Company Operations Standard
Gas Standard
Gas Operations & System Integrity**

Public Awareness Plan	SCG:	PA-1
------------------------------	-------------	-------------

- Obtain feedback from responsible departments/ audience owners (see Table 1) about possible improvements/ changes
- Compile findings into written annual review document (Annual Senior Management Report)
- Communicate findings to key personnel and obtain approval for major program changes, if any
- Update Public Awareness Plan and implement program changes, if any
- Obtain additional resources as necessary

See **Appendix M. Program Implementation Process** for detailed process steps.

Any substantial changes to this Public Awareness Plan will be reflected in the reviews and/or revisions log (see **Appendix N**).



Company Operations Standard Gas Standard Gas Operations & System Integrity

Public Awareness Plan	SCG:	PA-1
-----------------------	------	------

Appendix

APPENDIX A. PUBLIC AWARENESS SUPPORT TEAM MEMBERS

Public Awareness Team’s Responsibilities:

This is an intra-company group consisting of representatives of the key departments that are responsible for communications with the targeted audiences and are involved in the development and implementation of public awareness communications. It consists of representatives from **SoCalGas Customer Engagement & Insights** and **SDG&E Marketing, Research and Analytics (aka “Communications”), Distribution Integrity Management, Gas Operations, Media and Employee Communications, Public Affairs, Legal, Emergency Services, Storage Operations, Storage Integrity and Transmission Operations**. Other departments have support roles. These combined groups make up the Public Awareness Support Team.

- **Communications** handles all paid communications to customers, non-customers, excavators/ contractors, farmers and land developers and reviews and/or writes other customer communications such as bill inserts, emails, letters, videos, call center talking points, etc. Performs annual audit of these targeted audiences to ensure these communications are being implemented and documented according to the plan.
- **Pipeline Safety and Compliance** manager provides annual dig-in reports to the PAA, including the causes of these incidents and whether Underground Service Alert (USA) One-Call was notified to determine if increased public awareness communications can reduce the number of incidents.
- **Claims Management** documents communications with contractors that have caused multiple damages to Company facilities.
- **Communications - Research** manages the effectiveness evaluations and provides recommendations for any changes needed to meet the program’s objectives.
- **Fleet Services** places “Call 811 Before You Dig” stickers on Company Transmission, Distribution, and Customer Service vehicles to increase public awareness of this important safety message.
- **The GIS team** provides the shape files and printed maps that can be used by a third-party vendor to identify the affected public along Company DOT lines (refer to [Gas Standard 223.0415](#), Pipeline and Related Definitions) inside and outside the service territory and near the storage fields and compressor stations. Also provides annual update of HCA/Non-HCA designation for each city in the service area to the PAA.



A Sempra Energy utility

Company Operations Standard Gas Standard Gas Operations & System Integrity

Public Awareness Plan	SCG:	PA-1
------------------------------	-------------	-------------

- **Gas Operations** provides grid updates to USA whenever there are changes in the gas pipeline system
- **Remittance Processing – Regional Branch Office** displays public awareness safety brochures in branch offices throughout service area.
- **Customer Contact Centers** is responsible for rotating the 811 message (English and Spanish) on the Interactive Voice Response (IVR) system as customers are on-hold while waiting to speak to a representative (SoCalGas only).
- **Major Projects – Project and Construction Management, PSEP** documents communications to the public for major maintenance and construction projects.
- **Media and Employee Communications** is responsible for internal employee communications and non-paid external media news release to all affected public within the distribution service territory in languages as determined by the PAA.
- **Legal** reviews all new and materially modified communications prior to distribution.
- **Public Affairs** is responsible for identifying and communicating with appropriate public officials within the service territories and along the Company's gas transmission lines. Also responsible for communications to affected public near construction sites for major maintenance projects in conjunction with field supervisors and/or project managers. Performs annual audit to ensure the communications are being implemented at cities and counties in service area.
- **Real Estate & Land Services** notifies the PAA of increasing ROW encroachment that can be reduced by increased public awareness communications.
- **Emergency Services** ensures that all required communications with emergency officials occur, which includes communications with the 13 Emergency County Coordinator Officials and all fire department agencies. Performs annual audit to ensure these communications are being implemented and documented. Also documents the joint pipeline emergency communications by the High Desert Pipeline Team which consists of other pipeline companies in the High Desert Area.
- **SDG&E Gas Distribution Field Operations** will participate in *two* annual USA One-call meetings for excavators and contractors in SDG&E's service territory. **SoCalGas Gas Operations** works closely with USA One-Call to attempt to have two meetings per Distribution Region with excavators and contractors for a total of *eight* annual meetings in SoCalGas service territory. These meetings are documented and records of these events are provided to the PAA. Provides SoCalGas territory USA tickets annually to **the PAA** to be used to report dig-ins per 1,000 USA tickets and to analyze trends for effectiveness of communications in reducing pipeline damages.
- **Storage Operations** – Annually reviews the public awareness plan and notifies the PAA if any additional communications requirements are needed.
- **Storage Integrity** - Annually reviews the public awareness plan and notifies the PAA if any additional communications requirements are needed.



A Sempra Energy utility

Company Operations Standard
Gas Standard
Gas Operations & System Integrity

Public Awareness Plan	SCG:	PA-1
-----------------------	------	------

- **Transmission Operations**, as part of the High Desert Pipeline Team, meets with local emergency officials in the area which includes San Bernardino and Kern Counties. Documents these meetings and any additional meetings with emergency officials. Also documents communications to the public for major maintenance and construction.
- **Pipeline Integrity—Distribution** annually provides and reviews the dig-in data (damages) along with the Public Awareness Administrator to identify trends and possible plan changes to enhance the Public Awareness Program.
- **Pipeline Integrity—Transmission** annually reviews the Public Awareness Plan and notifies **the PAA** if any additional communication requirements beyond 49 CFR 192.616 are needed to meet Pipeline Integrity requirements.
- **Customer Engagement and Insights - Web Group** provides links for paperless customers to access on-line Public Awareness Bill Inserts.



A Sempra Energy utility

Company Operations Standard Gas Standard Gas Operations & System Integrity

Public Awareness Plan	SCG:	PA-1
-----------------------	------	------

APPENDIX B. OTHER LANGUAGES PROVIDED

“Significant” Definition: API RP 1162 states that *“The programs are to be provided in both English and in other languages commonly used by a significant concentration of non-English speaking population along the pipeline.”* Since “significant” was not specifically defined, SoCalGas/SDG&E takes the initiative to define “significant” in its Public Awareness Program as any population group that constitutes greater than **one percent** of the adults who speak another language at home and speak English less than very well.

Determination of Languages: Annually or once new data is released by the U.S. Census, the PAA conducts an assessment of languages within the service territory, as well as areas where transmission lines reside outside of the service territory. Instruction to make this determination is below.



Microsoft Word 97 -
2003 Document

Currently, all customers receive gas safety messages in English and Spanish through bill stuffers at least twice annually. Additionally, the gas safety messages are provided in English and Spanish on company’s website. Excavators/ contractors, land developers and farmers receive the gas safety messages in English and Spanish. Because emergency responders and public officials are expected to communicate in English, no additional language versions were deemed necessary for these audiences.

To help educate and build awareness about natural gas pipeline safety to our Asian customers, the company runs an annual campaign in Asian languages. The campaign includes print ads in newspapers and other appropriate publications that are most likely to reach the specific Asian segment.



Attachment R
**Company Operations Standard
Gas Standard
Gas Operations & System Integrity**

Public Awareness Plan	SCG:	PA-1
------------------------------	-------------	-------------

APPENDIX C. IDENTIFICATION OF SCHOOLS

School Districts

The PAA or designated third-party vendor will identify the superintendents/chancellors of each elementary and high school and community college district and university within the company's service territory. We are communicating to district superintendents instead of principles at individual schools because the superintendents are responsible for the overall safety policy and emergency preparedness for all schools within the district. Furthermore, as we communicate to the affected public near our transmission lines and facilities, individual schools near our ROW also receive public awareness brochures by direct mail.

Procedure to obtain the contact list for public schools and districts is attached:



Microsoft Word 97 -
2003 Document



A Sempra Energy utility

Company Operations Standard Gas Standard Gas Operations & System Integrity

Public Awareness Plan	SCG:	PA-1
------------------------------	-------------	-------------

APPENDIX D. SAMPLING MARGIN OF ERROR

Margin of Error

The PAA works with **Communications Research** group and consults with a third-party research firm to determine the methodology for conducting the survey and the sample size needed to receive an acceptable margin of error. Industry standard for margin of error for survey sampling is around 5% based on a 95% confidence level. Using these criteria and the formula for margin of error, a sample size of about 350 will give pollsters this margin of error regardless of the population size (refer to Excel file below). However, there are times when the population count is much less (i.e. public officials, county emergency coordinators, or affected public near a compressor station) and it would not be feasible to obtain a sample size of 350. The PAA will make a determination to poll the entire population (census survey) and rely on the most appropriate method to conduct the survey to obtain the highest response rate.

Below is the worksheet to determine the sample size.



Microsoft Excel
97-2003 Worksheet



A Sempra Energy utility

Company Operations Standard Gas Standard Gas Operations & System Integrity

Public Awareness Plan	SCG:	PA-1
-----------------------	------	------

APPENDIX E. PROCEDURE TO DEVELOP SHAPE FILES AND MAILING LIST OF AFFECTED PUBLIC NEAR PIPELINES OR FACILITIES

Shape files along DOT Pipelines

Every other year, the GIS team develops shape files with center lines for the following audience:

1. Affected Public near DOT-T pipeline ROW inside DST
2. Affected Public near DOT-T pipeline ROW outside DST
3. Affected Public near DOT-T equipment inside storage fields
4. Affected Public near DOT-T equipment inside compressor stations

This project requires the following responsible parties and procedures.

1. For affected public near DOT-T pipelines, the **GIS** group uses company records to map DOT-T pipelines (refer to Gas [Standard 223.0415](#), Pipeline and Related Definitions) and draw shape files of 660 feet on either side or greater (depending on HCA and PIR) along the pipelines. The **PAA** stores the shape files used in most recent mailing on an internal company network drive and/or a centralized web-based tracking system – ICAM.
2. For affected public near compressor stations, the **GIS** group uses company records to draw shape files of 660 radiating from all DOT-T equipment and along DOT-T pipelines inside the facility. For affected public near storage fields, the **GIS** group uses Company records to draw shape files of the storage boundaries, including the storage buffer zone. The **PAA** also works with **Transmission** and **Storage Operations** to determine whether any updates to the facilities (i.e., movement of equipment or line abandonment or reclassification) require a redraw of the shape files and communicate this to the **GIS** group. The **PAA** stores the shape files used in the most recent mailing on the internal company network drive and/ or ICAM and if no changes are notified by **Transmission** and **Storage Operations**, the **GIS** will use these files for the next update.
3. The **PAA** selects a third-party vendor, coordinates communication between the **GIS** group and the vendor, and provides the shape files to the vendor for the extraction of a mailing/contact list. The **PAA** confirms that the vendor flags whether the affected public is a resident, business, or school.
4. The **PAA** provides the mailing list to Communications for direct mail.



**Company Operations Standard
Gas Standard
Gas Operations & System Integrity**

Public Awareness Plan	SCG:	PA-1
------------------------------	-------------	-------------

APPENDIX F. OVERVIEW OF PIPELINE ASSOCIATION FOR PUBLIC AWARENESS' (PAPA) EMERGENCY RESPONDER PROGRAM

Annually, PAPA identifies emergency officials in counties in which the company operates and provides pipeline safety communications to this audience through direct mail.

Definition of Target Audience by PAPA: The program is directed toward local, state, or regional officials, agencies, and organizations emergency response and/or public safety jurisdiction over areas involving pipelines. These agencies include: Fire departments, Police/Sheriff departments and Public Safety Answering Points (PSAP), Local Emergency Planning Commissions (LEPC), County Emergency Management Agencies (CEMA), other local emergency response and public safety organizations.

Methods to Identify Stakeholder Group: Emergency Officials are identified through commercially available data sources, member information, and the web sign up database. The primary mailing list is maintained internally by PAPA. Additional data is obtained from the National Public Safety Information Bureau. Background information about this list service can be found at: www.safetysource.com. InfoUSA is used as a second source of data for agency locations. Data used in the mailing list is CASS certified, normalized, combined, and duplicates removed.

PAPA Program Elements: The elements in the program include:

- A direct mailing of the Pipeline Emergency Response Guidelines booklet with the training CD and the Pipeline Awareness newsletter for public officials. The mailing packet will include a customized cover letter listing the names of member companies in the county along with a description of the types of facilities they operate and their emergency and non-emergency phone numbers.
- An online interactive training web site with various pipeline emergency scenarios.
- The online training resource: Responding to Utility Emergency Emergencies.
- A mobile friendly web application providing pipeline information for specific locations.
- A web based listing of emergency response capabilities for pipeline members and emergency response agencies.
- A password protected web based mapping application displaying pipeline specific information for emergency planning purposes (company name, product transported, pipeline size, recommended evacuation distance, emergency phone, non-emergency phone, and links to additional documents).



A Sempra Energy utility

Company Operations Standard Gas Standard Gas Operations & System Integrity

Public Awareness Plan	SCG:	PA-1
------------------------------	-------------	-------------

- Email communications to the emergency management organizations, fire departments, and law enforcement agencies who have provided their email addresses to the Association during past communications.

PAPA Message Content

The following information will be communicated to the Emergency Responders by PAPA:

- Availability of the National Pipeline Mapping System (NPMS) and how to learn the location of pipelines in their area of jurisdiction,
- Names of pipeline operators and their emergency contact information,
- Information about potential hazards associated with natural gas, hazardous liquids, and other materials transported by pipeline,
- Information about how to safely respond to a pipeline emergency and general Emergency Response Procedures,
- General information about the emergency response capabilities of pipeline operators and the capabilities expected of first responders,
- An overview of what operators do to prevent accidents and mitigate the consequences of accidents when they occur,
- How to contact pipeline operators to obtain additional information about specific pipelines, Integrity Management Programs to protect High Consequence Areas, emergency preparedness, or other public safety matters.

PAPA Documentation:

All program documentation will be available from the PAPA website, including: identity of participating members, Emergency Responders contacted, copies of communications, proof of mailing and any survey results or feedback received.

PAPA Program Effectiveness Evaluation:

An evaluation of the PAPA program effectiveness will be performed at least once every four years by PAPA.



A Sempra Energy utility

Company Operations Standard Gas Standard Gas Operations & System Integrity

Public Awareness Plan	SCG:	PA-1
-----------------------	------	------

APPENDIX G. OVERVIEW OF PIPELINE ASSOCIATION FOR PUBLIC AWARENESS' (PAPA) PUBLIC OFFICIALS PROGRAM

Annually, PAPA identifies public officials in counties in which the company operates and provides pipeline safety communications to this audience through direct mail.

Definition of Target Audience by PAPA: The PAPA program is directed toward local, city, county or state officials and/or their staffs having land use and street/road jurisdiction in areas where pipelines are located and include: Planning boards, Zoning board, Licensing departments, permitting departments, Building code enforcement departments, City and county managers, Public and government officials, Public utility boards, Includes local Governing Councils as defined by many communities, Public officials who manage franchise or License agreements

Methods to Identify Stakeholder Group: Public Officials will be identified through commercially available data sources (InfoUSA website and American Planning Association website).

PAPA Program Elements: The elements in the program will be a mailing of the Pipeline Awareness newsletter that includes a custom cover letter listing member companies by state or county and additional information available on the website.

PAPA Message Content:

- Pipeline purpose and reliability
- Awareness of hazards and prevention measures undertaken
- Emergency preparedness communications
- Land use practices associated with the pipeline ROW that may affect community safety
- General One-call requirements
- Pipeline location information and availability of NPMS
- How to get additional information about public safety issues, additional overview information on Integrity Management Programs to protect High Consequence Areas under their jurisdiction, land use practices, emergency preparedness, or other matters.

PAPA Documentation:

All program documentation will be available from the PAPA website, including: identity of participating members, Public Officials contacted, copies of communications, and any survey results or feedback received.

Program Evaluations



A Sempra Energy utility

Attachment R
**Company Operations Standard
Gas Standard
Gas Operations & System Integrity**

Public Awareness Plan	SCG:	PA-1
------------------------------	-------------	-------------

At a minimum, an evaluation of program effectiveness will be performed every four years by PAPA.



A Sempra Energy utility

Company Operations Standard Gas Standard Gas Operations & System Integrity

Public Awareness Plan	SCG:	PA-1
------------------------------	-------------	-------------

APPENDIX H. VENDOR’S AUDIENCE IDENTIFICATION VERIFICATION PROCESS AND MEASUREMENTS OF REACH

Audience identification process

Enertech, a mailing list vendor, provides mailing lists for the following audiences:

- Affected Public along pipeline ROW inside and outside DST
- Affected Public Near Compressor Stations and storage fields
- Excavators

Enertech’s **affected public audience identification process** is outlined in this document:



Adobe Acrobat
Document

Enertech’s **excavators’ identification process** is outlined below:

Three types of data sets are used to identify Excavators:

- Compiled
 - Data is compiled based upon companies’ incorporations, tax returns and business activities.
- Response
 - Data is compiled based upon response from companies on surveys, equipment rebate cards, equipment warranty information etc.
- California Licensing Board
 - Data is compiled by the California Licensing Board.

Various compiled and responses data providers along with the California Licensing Board data were used to identify Excavators with business addresses within the SoCalGas and SDGE Asset Counties.

Combining compiled, response and licensing board data gives a very accurate identification process of Excavators with business addresses within the SoCalGas and SDGE Asset Counties.

Verification/ validation process and measurements of reach:

To validate that required stakeholders are on the purchased mailing list and the list is accurate, the PAA will

Public Awareness Plan	SCG:	PA-1
------------------------------	-------------	-------------

1) Review the SIC/ NAICS codes to be used for the extraction of the required stakeholders. The SIC/ NAICS codes list is below:



Microsoft Excel
97-2003 Worksheet

2) Obtain CASS/ DPV reports

- **CASS Report:** CASS is a certification system from the United States Postal Service (USPS) for address validation. A CASS-certified address validation service will standardize the mailing list, *update outdated addresses, and verify that addresses are valid and complete.* CASS doesn't take into consideration whether a specific address physically exists and if mail can be delivered to it. The DPV (Delivery Point Validation) software will be used to validate that mail can be delivered to the address.
- **DPV Report:** The DPV system is one of the SnappCheck Address Management Technologies™ products that is available from the Postal Service to help mailers identify *inaccurate or incomplete addresses.* The DPV System assists mailers in obtaining accurate delivery address information and facilitates identification of erroneous addresses contained in mailer address files.

3) Review previous years USPS postage statements and compare total pieces mailed with the total contacts on the newly provided contact list. If the number of contacts fluctuates, the PAA should investigate the cause for this difference.



A Sempra Energy utility

**Company Operations Standard
Gas Standard
Gas Operations & System Integrity**

Public Awareness Plan	SCG:	PA-1
------------------------------	-------------	-------------

APPENDIX I. RETURN AND UNDELIVERABLE MAILING INSTRUCTIONS

1. The returned mail will be gathered and entered into the return mail data spreadsheets.
2. Each envelope is opened to determine the mailing type (e.g. affected public, schools, excavators, etc.) and the year of the mailing.
3. The returns to be entered into an appropriate return mail spreadsheet. The following fields should be completed: return, return date, return reason, new mailing address (if any).
4. If the return has a new address, then re-send materials to that new address.
5. All the returns to be kept for records for a period of **five years**. To store the returns:
 - i. Contact Records Support Services (email at RecMgmt@SDGE.com), request the Iron Mountain Deposit Form, complete it and return it back to the Records Support Services
 - ii. Contact Mail Cent (email at GTMail@sempra.com) to arrange for a pick up



A Sempra Energy utility

Attachment R
Company Operations Standard
Gas Standard
Gas Operations & System Integrity

Public Awareness Plan	SCG:	PA-1
------------------------------	-------------	-------------

APPENDIX J. METHOD OF COMMUNICATION AND DOCUMENTATION

Audience	Responsible Party	Method	Records of Communication
Customers	CE&I/ MR&A	Bill stuffers	Copy of bill stuffer.
		Email	Copy of email, report from Silverpop (email vendor) that includes number of emails sent, opened and bounced.
Affected Public	CE&I/ MR&A	Web/Social media	Number of hits to safety page, safety sweepstake on FB.
	Media Commun.	PR News release	Copy of news-release.
	CE&I/ MR&A	Local outreach	Invitation or our sign-up to commit to the event, photos of booth, summary of visits such as the number of brochures handed-out, and people who stopped at the booth.
Affected public near DOT-T pipeline or equipment	CE&I/ MR&A	Direct mail	Copy of mailing list, letter/ brochure, envelope, proof of mailing (PS FORM 3697) including number of pieces mailed and date, GIS shapes files.
Schools	CE&I/ MR&A	Direct Mail	Copy of contact list, letter/ brochure, envelope, proof of mailing (PS FORM 3697) including number of pieces mailed and date, GIS shapes files.
		Or Email	Or Copy of contact list, email, and report from Silverpop (email vendor) with number of emails sent, opened and bounced.
Emergency Responders	SoCalGas Emergency Services/ SDG&E ER&BR	Meeting: in person, phone.	Email confirming the meeting; date, ER name, title and jurisdiction, meeting agenda/ discussed topics.
		Briefing events	Invitation, agenda, presentation, maps, handout, sign-up sheet.
		Email	Copy of e-mail, email read-receipt. If through Silverpop/ email vendor: List of Emergency Officials contacted, copy of sent e-mail, number of emails sent, opened and bounced.
		Direct Mail: print materials	Copy of mailing/ contact list, copies of distributed print materials, confirmation of mailing.
Public Officials (city/county)	Public Affairs	Meeting: in person, phone.	Email confirming the meeting; public official name, title and jurisdiction, meeting agenda/ discussed topics.
		Briefing events	Invitation, agenda, presentation, sign-up sheet.
		Email	Copy of e-mail, email read-receipt. If through Silverpop/ email vendor: List of Public Officials contacted, copy of sent e-mail, number of emails sent, opened and bounced.
		Direct Mail: print materials	Copy of mailing/ contact list, copies of distributed print materials, confirmation of mailing.
Excavators	SoCalGas Gas Ops. Services / SDG&E Gas Distr. Field Ops.	Excavator Event	Invitation, agenda, presentation, sign-up sheet, discussed topics.
	CE&I/ MR&A	Direct Mail	Copy of mailing list, letter/ brochure, envelope, proof of mailing (PS FORM 3697) including number of pieces mailed and date, GIS shapes files.



A Sempra Energy utility

Company Operations Standard Gas Standard Gas Operations & System Integrity

Public Awareness Plan	SCG:	PA-1
------------------------------	-------------	-------------

APPENDIX K. COMMUNICATIONS REQUIRED BY TARGETED AUDIENCE

Targeted Audience	Message Types	Delivery Methods	Frequency							
			Public Relations	Internal Communications	Communications (SoCalGas CE&I/SDGE MR&A)	Public Affairs	SoCalGas Emergency Serv./SDG&E ER&BR	Claims	Gas Operations Services / Distribution Operations	Transm. Operations
Customers	1. Message A <u>Supplemental</u> 1. Pipeline location info, including pipeline markers information 2. One-call requirements 3. IMP Summary for HCA 4. ROW encroachment prevention 5. Availability of NPMS (to capture customers near Trans Lines) 6. Major maintenance/construction activity 7. Odor Fade 8. Maintain your gas lines	1. Bill stuffer <u>Supplemental</u> 1. Brochures 2. Email (paperless customers) 3. Other safety communications.			Semi-Annual <u>Supplemental</u> 1. <u>New customers:</u> FYI bill insert/ Onsert 2. Advertising campaign in Asian languages - Ethnic/community print and/ or online ads.	<u>Supplemental</u> As appropriate for major maintenance/construction activity			<u>Supplemental New Customers</u> (at time of gas service turn on): Home Energy Guide (Customer Services)	<u>Supplemental</u> USA 811 bumper stickers on Company existing and new fleetvehicles
Affected Public Within Distribution Service Territory	1. Message A <u>Supplemental</u> Major maintenance/construction activity	1. Public service announcements 2. Non-paid media relations <u>Supplemental</u> 1. Print advertising in target areas in English & Spanish 2. Paid advertising in additional Asian markets 3. Brochures	Annual		Annual <u>Supplemental</u> 1. Asian market languages: 2. As appropriate for major maintenance/construction activity			<u>Supplemental</u> As appropriate for major maintenance/construction activity	<u>Supplemental</u> As appropriate for major maintenance/construction activity	



A Sempra Energy utility

Company Operations Standard Gas Standard Gas Operations & System Integrity

Public Awareness Plan

SCG:

PA-1

Targeted Audience	Message Types	Delivery Methods	Frequency							
			Public Relations	Internal Communications	Communications (SoCalGas CE&I/SDGE MR&A)	Public Affairs	SoCalGas Emergency Serv./SDG&E ER&BR	Claims	Gas Operations Services / Distribution Operations	Transm. Operations
Affected Public Along DOT Pipelines Inside and Outside of Distribution Service Territory and Places of Congregation	1. Message A 2. Pipeline location info, including pipeline markers information 3. One-call requirements 4. Availability of NPMS <u>Supplemental</u> 1. IMP Summary for HCA 2. ROW encroachment prevention 3. Major maintenance/construction activity 4. Odor Fade	1. Direct Mail 2. Pipeline Marker <u>Supplemental</u> 1. Brochure 2. Non-paid media relations	Additional Messages <u>Supplemental</u> As appropriate for major maintenance/construction activity		Every 2 years <u>Supplemental</u> As appropriate for major maintenance/construction activity	<u>Supplemental</u> As appropriate for major maintenance/construction activity				<u>Supplemental</u> As appropriate for major maintenance/construction activity
Affected Public Near Compressor Stations/Storage Fields	<u>Supplemental</u> 1. IMP Summary for HCA 2. Incident response notification and evacuation (if appropriate) 3. Facility Purpose 4. Assurance security has been considered	<u>Supplemental</u> 1. Direct mail								



Company Operations Standard Gas Standard Gas Operations & System Integrity

A Sempra Energy utility

Public Awareness Plan	SCG:	PA-1
------------------------------	-------------	-------------

Targeted Audience	Message Types	Delivery Methods	Frequency								
			Public Relations	Internal Communications	Communications (SoCalGas CE&I/SDGE MR&A)	Public Affairs	SoCalGas Emergency Serv./SDG&E ER&BR	Claims	Gas Operations Services / Distribution Operations	Transm. Operations	
Emergency Officials	<ol style="list-style-type: none"> 1. Pipeline purpose & reliability 2. Awareness of hazards and prevention measures undertaken by the operator 3. Emergency preparedness communications and contacts 4. Potential Hazards of product transported 5. Pipeline Location Information and availability of NPMS 6. IMP Summary for HCA 7. How to get additional Information, including how to access company's Emergency Plan 8. One-Call requirements <p><u>Supplemental</u></p> <ol style="list-style-type: none"> 1. Major maintenance/construction activity 2. Odor Fade 	<ol style="list-style-type: none"> 1. Meeting 2. Email 3. Direct Mail <p><u>Supplemental</u></p> <p>Emergency tabletop exercises as requested</p>						Annual - Thirteen County Emergency Coordinators		Document any meetings with Emergency Officials	<p><u>Supplemental</u></p> <ol style="list-style-type: none"> 1. Holds joint annual meetings in High Desert Area 2. Document any meetings with Emergency Officials 3. As appropriate for major maintenance / construction activity
Public Officials (City Managers, County Managers)	<ol style="list-style-type: none"> 1. Pipeline purpose & reliability 2. Awareness of hazards and prevention measures undertaken by the operator 3. Emergency preparedness communications 4. Pipeline location information and 	<ol style="list-style-type: none"> 1. Email 2. Meeting 3. Direct Mail 					<ol style="list-style-type: none"> 1. HCA City Managers – Annual 2. County Managers – Annual 3. Non-HCA 				



A Sempra Energy utility

Company Operations Standard Gas Standard Gas Operations & System Integrity

Public Awareness Plan	SCG:	PA-1
------------------------------	-------------	-------------

Targeted Audience	Message Types	Delivery Methods	Frequency								
			Public Relations	Internal Communications	Communications (SoCalGas CE&I/SDGE MR&A)	Public Affairs	SoCalGas Emergency Serv./SDG&E ER&BR	Claims	Gas Operations Services / Distribution Operations	Transm. Operations	
	availability of NPMS 5. Integrity Management Plan (IMP) Overview 6. One-call requirements 7. How to get additional information, including how to access company's Emergency Plan <u>Supplemental</u> 8. HCA designation (if applicable) 9. ROW encroachment prevention 10. Major maintenance/construction activity 11. Odor Fade						City Managers – Every 3 Years <u>Supplemental</u> As appropriate for major maintenance/construction activity				<u>Supplemental</u> As appropriate for major maintenance/construction activity
Contractors who excavate, Land Developers, and Farmers in counties where we operate	1. Message A 2. One-call requirements 3. Pipeline Location 4. Availability of NPMS <u>Supplemental</u> 5. Odor fade	1. Direct Mail 2. One-call center outreach/meetings 3. Pipeline Marker <u>Supplemental</u> 1. Non-paid media relations 2. Direct Mail 3. Mailers to or meetings with contractors with multiple damages	Additional Messages		Annual – contractors/excavators <u>Supplemental</u> 1. Annual – famers 2. Every 2 years-land developers				<u>Supplemental</u> As needed to contractors with multiple damages	Attempt to hold two annual USA One-Call excavator meetings per Distribution Region	Participate in USA One-Call meetings as needed.



Company Operations Standard Gas Standard Gas Operations & System Integrity

Public Awareness Plan	SCG:	PA-1
------------------------------	-------------	-------------

Targeted Audience	Message Types	Delivery Methods	Frequency								
			Public Relations	Internal Communications	Communications (SoCalGas CE&I/SDGE MR&A)	Public Affairs	SoCalGas Emergency Serv./SDG&E ER&BR	Claims	Gas Operations Services / Distribution Operations	Transm. Operations	
One-Call Centers	Provide updated pipeline and other information per USA One-Call Center requirements. Participate in excavator meetings.	1. Membership 2. Maps 3. Meeting								Annually review to ensure compliance with USA One-Call requirements	
Company Employees (Management & Appropriate Personnel)	<u>Additional</u> 1. Message A 2. Odor Fade	<u>Additional</u> One or more of the following: 1. Link (bimonthly newsletter) 2. Sempra News 3. Quick Link		<u>Additional</u> Annual							

Notes for Table above:

Baseline Message A

1. Pipeline purpose and reliability
2. Awareness of hazards and prevention measure taken
3. Damage Prevention Awareness
4. Leak recognition and response
5. How to get additional information

IMP – Integrity Management Plan
HCA – High Consequence Areas defined in IMP
NPMS – National Pipeline Mapping System



Attachment R
**Company Operations Standard
 Gas Standard
 Gas Operations & System Integrity**

Public Awareness Plan	SCG:	PA-1
------------------------------	-------------	-------------

APPENDIX L. THIRD-PARTY VENDORS

Third-Party Vendor	Role
SDG&E	
Agnew Multilingual	Asian Language translation
Anderson Direct Marketing	Mailing Agency
MeadsDurket	Asian Language advertising
MeadsDurket	Traffic Radio
MeadsDurket	Padres ID
MeadsDurket	Media personality (Loren Nancarrow) to promote damage prevention
MeadsDurket	San Diego Union Tribune newspaper
JD Power	Customer Satisfaction Survey
PI Confluence	Develops ICAM - Public Awareness Event Tracking system
Travis Research	Gathers information and prepares effectiveness studies
PAPA	Conducts a targeted direct mail program for Public and Emergency Officials.
Enertech	Provides mailing list for 1) non-customers along transmission lines inside DST, 2) affected public near compressor stations and storage fields, 3) excavators/ contractors, farmers, land developers, and 4) schools.
SoCalGas	
Agile	Provides temp personnel (mostly retired SoCalGas employees at outreach events (i.e. county fairs, community outreach)
Agnew	Language translations for Pipeline Brochure (Asian) and Home Energy Guide (Other Languages)
Cyera	Provides support for audit and industry-wide intelligence.
EOS	Mailing Agency
Phelps	2014 Safety Campaign
Davis Research, LLC	Itracker. Quarterly phone survey about safety message.
Intertrend	Asian-language advertising
JD Power	Customer Satisfaction Survey
PI Confluence	Develops ICAM - Public Awareness Event Tracking system
Rogelio Camacho	Spanish language translations
Sensis	Facebook campaign
Silverpop	Sends emails and provides metrics
Travis Research	Gathers survey information and prepares effectiveness studies.
PAPA	Conducts a targeted direct mail program for Public and Emergency Officials.
Enertech	Provides mailing list for 1) non-customers along transmission lines inside/ outside DST, 2) affected public near compressor stations and storage fields, 3) excavators/ contractors, farmers, land developers, and 4) schools.



A Sempra Energy utility

Company Operations Standard Gas Standard Gas Operations & System Integrity

Public Awareness Plan	SCG:	PA-1
------------------------------	-------------	-------------

APPENDIX M. PROGRAM IMPLEMENTATION PROCESS

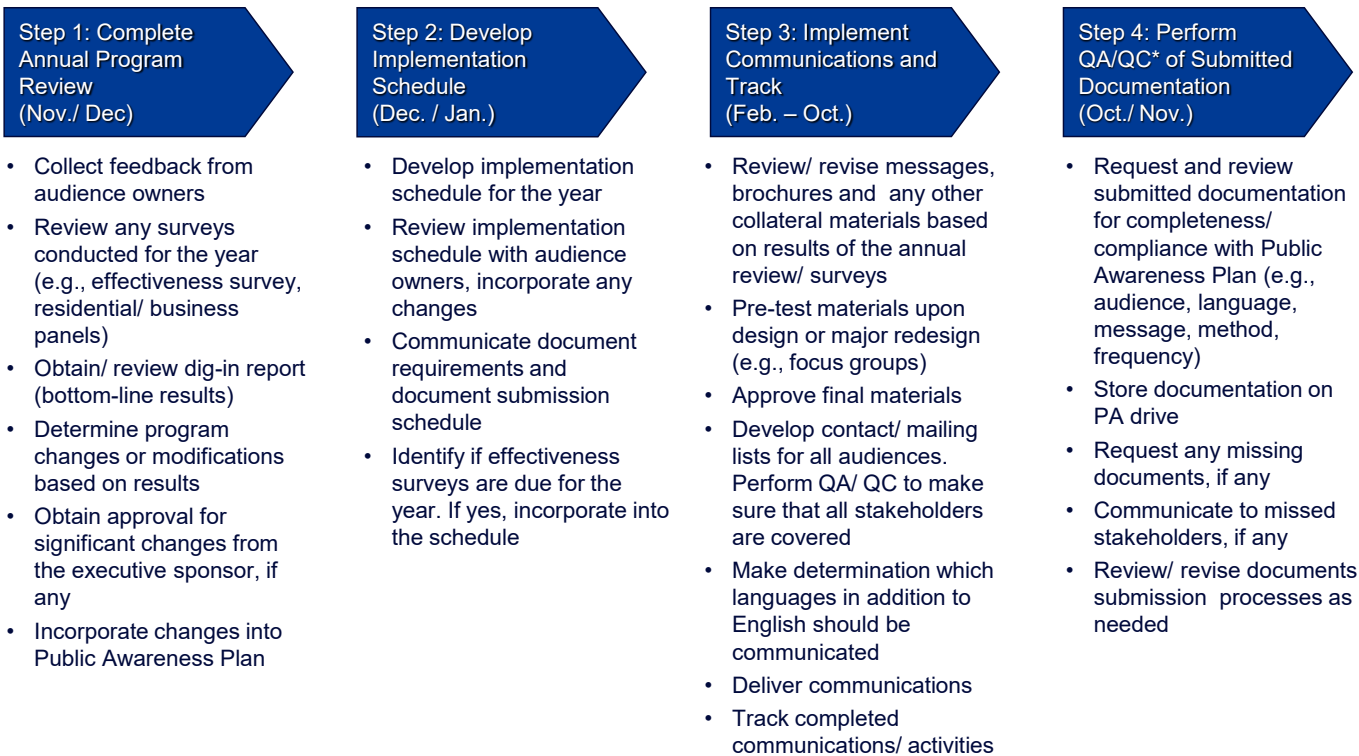

QA/QC *– Quality Assurance/ Control



A Sempra Energy utility

**Company Operations Standard
Gas Standard
Gas Operations & System Integrity**

Public Awareness Plan	SCG:	PA-1
------------------------------	-------------	-------------

APPENDIX N. REVIEW AND REVISION LOG

This Public Awareness Plan must be reviewed annually to assure that there has been a self-assessment of the implementation of this plan. Any *substantial* changes to this Plan will be reflected in the reviews and/or revisions log.

Date	Change	Revision Justification	Prepared By
4/4/2014	Date change from 12/6/11 to 4/4/2014		Dina Chanyшева
4/4/2014	Added review/ revision log to PAP.	06/17/2013 Response to Audit Recommendations letter	Dina Chanyшева
4/4/2014	Added Executive Sponsor Signatory Affirmation Page (see Appendix O)	06/17/2013 Response to Audit Recommendations letter	Dina Chanyшева
4/4/2014	Added unique assets: Borrego Springs Liquefied Natural Gas (LNG) facility.	06/17/2013 Response to Audit Recommendations letter	Dina Chanyшева
4/4/2014	Added vendor’s Audience Identification Verification Process and Measurements of Reach (see Appendix I)	06/17/2013 Response to Audit Recommendations letter	Dina Chanyшева
4/4/2014	Added a process for addressing return and undeliverable mailings (see Appendix J)	06/17/2013 Response to Audit Recommendations letter	Dina Chanyшева
4/4/2014	Added an overview of PAPA programs for Emergency and Public Officials. (see Appendix G and H)	06/17/2013 Response to Audit Recommendations letter	Dina Chanyшева
4/4/2014	Expanded Program Evaluation section: added a process for conducting/ analyzing results of recommendations arising from the audits and reviews and how it will be implemented.	06/17/2013 Response to Audit Recommendations letter	Dina Chanyшева
4/4/2014	Added school officials to the Identification of Stakeholder Audiences table as a stand-alone audience. Moved “school officials” from the “public officials” section to a stand-alone section.	Schools officials were a subset of the public official’s audience. In order to have clear communication requirements for each audience, school officials were separated from the public officials.	Dina Chanyшева
4/4/2014	Updated the Identification of Stakeholder Audiences table: added Customers to "Non-Customers, Places of Congregation along pipeline ROW" definition and split the definition into 1) Affected Public along pipeline ROW inside DST 2) Affected Public along pipeline ROW outside DST. Added new section: "Affected Public along Transmission Lines Inside and Outside Distribution Service Territory" to the "Summary and Rational of Planned Communications by Audience" section.	To have more targeted communications for the affected public along ROW inside and outside DST.	Dina Chanyшева



A Sempra Energy utility

**Company Operations Standard
Gas Standard
Gas Operations & System Integrity**

Public Awareness Plan	SCG:	PA-1
------------------------------	-------------	-------------

4/4/2014	Added PAPA to the Identification of Stakeholder Audiences table as an entity that also identifies Public Officials, Excavators and School Districts.	Company signed up for PAPA communications for the following audiences: Public Officials since 2013, Excavators and School Districts will start to receive PAPA's communications in 2015. [Emergency officials since 2007]	Dina Chansheva
4/4/2014	Added PAPA mailers as an additional way of message delivery to the Public Official, Excavator and School Officials sections	Company signed up for PAPA communications for the following audiences: Public Officials since 2013, Excavators and School Districts will start to receive PAPA's communications in 2015. [Emergency officials since 2007]	Dina Chansheva
4/4/2014	Added Message Content Table by audience	To clarify required messages and frequencies by audience.	Dina Chansheva
4/4/2014	Reformatted the "Summary and Rationale of Planned Communications" section: added references to Table 2. Definition of Target Audience and Table 3. Messages Content; added Delivery Methods/ Materials, Message Frequency, Records and Responsible Party table to each audience.	To clarify communication requirements by audience.	Dina Chansheva
4/4/2014	Added supplemental County Emergency Response Coordinators survey. The survey to be conducted every four years at a minimum.	To evaluate Company's County Emergency Response Coordinators communications.	Dina Chansheva
4/4/2014	Added "Liaison with Emergency Responders" section.	To clearly define how we maintain relationship with emergency officials.	Dina Chansheva
4/4/2014	Added explanation of why the diameter of pipelines is not provided in NPMS maps (see "Liaison with Emergency Responders" section)	n/a	Dina Chansheva
4/4/2014	Revised Appendix A - Public Awareness Support Team Members: updated names/ titles/ departments	To update names/ titles/ departments.	Dina Chansheva
4/4/2014	Added Appendix L - Third-Party Vendors	To list all third-party vendors.	Dina Chansheva
4/4/2014	Updated and moved "Communications Required by Targeted Audience" table to the appendix section.	n/a	Dina Chansheva
4/4/2014	Added that groups that oversee company's major projects are responsible for creating, delivering and keeping track of communications with the affected public and public/emergency officials.	To clarify responsibilities. 7/27/17 response to CPUC Audit: Aliso Canyon Storage - Emergency Plan and PAP recommendations	Dina Chansheva
8/3/2017	Removed "public" to include private schools in our communications		Valerie Lertyaovarit



Attachment R
Company Operations Standard
Gas Standard
Gas Operations & System Integrity

Public Awareness Plan	SCG:	PA-1
------------------------------	-------------	-------------

8/3/2017	Added Call-On requirements to Message Content for Emergency Responders	7/27/17 response to CPUC Audit: Aliso Canyon Storage - Emergency Plan and PAP recommendations Per API RP 1171, storage operator should coordinate with existing pipeline public awareness plans where possible to address storage-specific communciations	Valerie Lertyaovarit
12/5/2017	Added language to satisfy requirements for CFR 192.12 Underground Natural Gas Storage Facilities and API RP 1171	Information that is outdated or no longer applies	Valerie Lertyaovarit
12/5/2017	Deleted portion of Appendix A that includes specific names of employees, Appendix B, and Appendix N	To clarify Emergency Services responsibilities	Valerie Lertyaovarit



A Sempra Energy utility

Company Operations Standard
Gas Standard
Gas Operations & System Integrity

Table with 3 columns: Public Awareness Plan, SCG:, PA-1

APPENDIX O. EXECUTIVE SPONSOR SIGNATORY AFFIRMATION

INSERT SCANNED COPY OF MOST RECENT SIGNATURE HERE

This Public Awareness Plan (the Plan) has been reviewed. During the annual review of the Plan, I, the sponsoring Executive of the Plan, approved this version and with my affirmation reflect management commitment to Public Awareness outreach.

SOUTHERN CALIFORNIA GAS COMPANY and SAN DIEGO GAS AND ELECTRIC

By: Jimmie Cho
Senior Vice President - Gas Operations & System Integrity



Appendix Q. Executive Sponsor Signatory Affirmation

INSERT SCANNED COPY OF MOST RECENT SIGNATURE HERE

This Public Awareness Plan (the Plan) has been reviewed. During the annual review of the Plan, I, the sponsoring Executive of the Plan, approved this version and with my affirmation reflect management commitment to Public Awareness outreach.

SOUTHERN CALIFORNIA GAS COMPANY and SAN DIEGO GAS AND ELECTRIC

By: Jimmie Cho
Senior Vice President - Gas Operations & System Integrity



Attachment R
**Company Operations Standard
 Gas Standard
 Gas Operations & System Integrity**

Public Awareness Plan	SCG:	PA-1
------------------------------	-------------	-------------

GLOSSARY

API RP 1162	American Petroleum Institute Recommended Practice 1162 – Public Awareness Programs for Pipeline Operators
Affected Public	Residents/homes, business, farms, schools, or any organizations that will be affected by gas pipelines or facilities.
Baseline messages	Required Public Awareness messages (depending on audience and operators) that must be communicated. Refer to Table 2-1 in API RP 1162. First Edition, December 2003
CPUC	California Public Utilities Commission
DST	Distribution service territory
DOT	US Department of Transportation
DOT-T	US Department of Transportation - Transmission
HCA	High Consequence Area.
ICAM	A secured web-based application developed by PI Confluence for documentation, track, and reporting.
IVR	Interactive Voice Response System used by the Call Center.
PAA	Public Awareness Administrator.
PAP	Public Awareness Plan.
PAPA	Pipeline Association for Public Awareness
PAT	Public Awareness Team.
PHMSA	Pipeline and Hazardous Materials Safety Administration
PSEP	Pipeline Safety and Enhancement Plan
ROW	Right-of-way.
Supplemental Messages	Additional safety messages to the baseline messages. Refer to Table 2-1 in API RP 1162. First Edition, December 2003



A Sempra Energy utility

Attachment R
**Company Operations Standard
 Gas Standard
 Gas Operations & System Integrity**

Public Awareness Plan	SCG:	PA-1
------------------------------	-------------	-------------

NOTE: Do not alter or add any content from this page down; the following content is automatically generated.

Brief: Updated mileage for pipelines in Section 1.
 Added language to satisfy requirements for CFR 192.12 Underground Natural Gas Storage Facilities and CPUC Code Section 956.5 and API RP 1171 in Sections 1 and 4, Table 2 in Section 5, Table 3 in Section 6.
 Added language to include face-to-face meeting/briefings with fire and police department regarding liaisons with emergency responders in Sections 7.7 and 7.8.
 Removed references to ICAM (no longer used for tracking purposes) throughout document.
 Deleted portion of Appendix A that includes specific names of employees, Appendix B and Appendix N because information is outdated or no longer applies.
 Corrected department names throughout document.

Document Profile Summary	
Responsible Person:	██████████
Published On:	12/11/2017
Last Full Review Completed On:	11/13/2014
Writer:	██████████
Document Status:	Active
Document Type:	GAS
Category (Prior FCD system only):	
If Merged, Merged To Document Number:	
Utility:	SoCalGas
Department:	Gas Operations & System Integrity
Number of Common Document (if applicable):	PA-1SD
Contains OPQUAL Covered Task:	No
Part of SoCalGas O&M Plan:	Yes
Part of SDG&E O&M Plan:	No
Last O&M Review date:	2017-09-25
O&M 49 CFR Codes & Impacted Sections of Document:	192.616: Entire Doc 192.615(c)(3): 7.8 192.615(c)(2): 7.8 192.615(c)(1): 7.8
Part of Non-O&M Parts 191-193 Plan	Yes
Non-O&M 49 CFR Codes & Impacted Sections of Document	192.16: 6 192.12: Entire Doc
Part of Distribution IMP (DIMP)	Yes
Part of Transmission IMP (TIMP)	Yes
Part of Storage IMP (SIMP)	No
Impacts GO112F	No
GO112F Codes & Impacted Sections of Document	
Impacts GO58A	No
GO58A Codes & Impacted Sections of Document	
Impacts GO58B	No
GO58B Codes & Impacted Sections of Document	
Indices/Binders in Which Document is Filed:	TRAN, TIMP2, STOR, EMGM, DISTM, DIMP2, SIMP2
NOP Learning Module (LM) Training Code:	NOP01530



Company Operations Standard Gas Standard Gas Operations & System Integrity

Prevention of Excavation Damage to Company Facilities	SCG:	184.09
---	------	--------

PURPOSE To provide guidelines for protection of Company underground facilities from excavation damage.

1. POLICY AND SCOPE

- 1.1. Company shall take actions with contractors and local agencies prior to excavation and construction activities to prevent damage to Company underground facilities.
- 1.2. The primary source of information regarding excavation near Company facilities is the USA One-Call System. Refer to [STANDARD 184.0200](#), *Underground Service Alert and Temporary Marking*.
- 1.3. Information regarding encroachment of Company right of ways is through transmission pipeline patrols. Refer to [STANDARD 223.0065](#), *Pipeline Patrol*.
- 1.4. **Authorized and qualified company representative** shall perform stand-by of construction activities to prevent damage to Company Facilities; stand-by is required for construction activities around high pressure gas facilities/high priority subsurface installation and shall be performed as necessary for low and medium pressure gas facilities/non-high priority subsurface installation.

2. RESPONSIBILITIES & QUALIFICATIONS

- 2.1. **Distribution, Transmission, Storage, Technical Services or District Supervisors:**
 - 2.1.1 Establish a system for keeping informed of public improvement projects, and for obtaining plans and schedules.
 - 2.1.2 Establish lines of communication with public agencies responsible for street maintenance that include resurfacing activities.
 - 2.1.3 **Distribution Region** should notify affected **Transmission Districts** and **Storage Operations** prior to power-operated boring or trenching when transmission lines are to be crossed or exposed.
 - 2.1.4 **Transmission districts, Distribution districts, and Storage Operations** should be kept informed of planned or actual construction activity involving construction equipment crossing, or any work within 10 feet adjacent to any high pressure facility, and as necessary schedules stand-by.
 - 2.1.5 **Distribution Regions** and **Transmission Districts** should provide the contractor with the approximate location of Company facilities in the proposed construction area along with any other pertinent substructure information pertaining to those facilities.

**Company Operations Standard
Gas Standard
Gas Operations & System Integrity**

Prevention of Excavation Damage to Company Facilities	SCG:	184.09
--	-------------	---------------

- 2.2. **Authorized and qualified company representative** satisfies and meets the guidelines set forth in **Operator Qualification**. See [STANDARD 167.0100, Operator Qualification Program](#).
- 2.3. **Line locator** is responsible for documenting locations, markouts, and any stand-by activities in MDT KorTerra® System under “Visit Remarks” in the Completion Screen or under “Remarks” in the Contact screens. See [STANDARD 184.0200, Underground Service Alert and Temporary Marking](#) for qualification requirements and other details.
- 2.4. The **authorized and qualified company representative** determines actions or activities required to verify the location of high pressure gas facility/high priority subsurface installation to avoid damage to company facilities.
- 2.5. **Distribution Regions, Transmission Districts and Company Contractors** are responsible for following this **STANDARD** and **STANDARD 184.0175, Prevention of Damage to Subsurface Installations**, to prevent damage to company facilities and other subsurface installations.
- 3 DEFINITIONS
- 3.1 “Authorized and qualified company representative” – Authorized and qualified, through Operations Training, company representative. See [STANDARD 167.0100, Operator Qualification Program](#).
- 3.2 “Company Facilities” – SoCalGas underground and aboveground natural gas facilities.
- 3.3 “Excavation” – Any operation in which earth, rock, or other material in the ground is moved, removed, or otherwise displaced by means of tools, equipment, or explosives in any of the following ways: grading, trenching, digging, ditching, drilling, auguring, tunneling, scraping, cable or pipe plowing and driving, or any other way.
- 3.4 “Hand tool” – Any tool that is operated solely by human effort, such as shovels, digging bars, etc.
- 3.5 “High Pressure Gas Facility” – A pipeline operating at greater than 60 psig. Also defined in California Government Code 4216 as a “high priority subsurface installation” (See [STANDARD 184.0200, Underground Service Alert and Temporary Marking Appendix A, 4216. \(e\)](#)).
- 3.6 “High Priority Subsurface Installation” – High pressure natural gas pipelines with normal operating pressures greater than 60 psig, petroleum pipelines, pressurized sewage pipelines, high voltage electrical supply lines, conductors or cables that have a potential to ground of more than 60,000 volts, or hazardous materials pipelines that

**Company Operations Standard
Gas Standard
Gas Operations & System Integrity**

Prevention of Excavation Damage to Company Facilities	SCG:	184.09
--	-------------	---------------

are potentially hazardous to employees, or the public, if damaged (See 184.0200, *Underground Service Alert and Temporary Marking*, Appendix A, 4216. (e)).

- 3.7 “Power-operated or power-driven excavating or boring equipment” – Tools and equipment operated, or assisted by, mechanical means instead of being operated solely by human effort. Examples of such mechanical means would include assistance by electric, hydraulic, and pneumatic forces. This includes tools such as, but not limited to, pneumatic clay diggers, pavement breakers, vacuum excavation devices, rock drills, etc.
 - 3.8 "Stand-by" – An activity performed by **authorized and qualified company representative** whose responsibilities include inspecting and monitoring excavation activities of company, and non-company crews for the prevention of damage to company pipelines. See [STANDARD 167.0100](#), *Operator Qualification Program*.
 - 3.9 “Subsurface Installation” – An underground pipeline, conduit, duct, wire, or other structure.
 - 3.10 “Transmission Line” – See [STANDARD 223.0415](#), *Pipeline and Related Definitions*.
 - 3.11 "USA" – An Underground Service Alert system that provides a one-call service that notifies owners of underground facilities for subsurface installation mark out of intended areas of excavation.
 - 3.12 “Safety-Related Pipeline Condition” - Refer to [STANDARD 183.06](#), *Region Reports of Safety Related Pipeline Condition*
- 4 PLAN REVIEW
- 4.1 **Technical Services or District** should provide agency and/or developer with:
 - 4.1.1 Any necessary drawings of company facilities within the project, or verification of Company facilities shown on their plans. Note any facilities that may be affected.
 - 4.1.2 Suggestions and reasons for altering the plans to minimize interference with Company facilities.
 - 4.1.3 Description of Company work anticipated as a result of the project.
 - 4.1.4 Preliminary estimate if work is collectible. Provide detailed estimate if requested by governmental agency.



Company Operations Standard Gas Standard Gas Operations & System Integrity

Prevention of Excavation Damage to Company Facilities	SCG:	184.09
---	------	--------

4.1.5 Technical Services or District should review preliminary and final project plans that were received to determine the extent of Company involvement and determine any interference with Company facilities.

4.1.6 The location of all isolation valves, all ‘other’ valves, or any other component that may be affected on the atlas sheet, plat sheet, or strip map that are included in the annual valve inspection maintenance program.

4.2 **Technical Services** is responsible for:

4.2.1 Review preliminary and final project plans that were received to determine the extent of Company involvement and determine any interference with Company facilities.

4.2.2 Determine if any critical valves or other street-level facilities are within the limits of a resurfacing project.

5 ACTION PRIOR TO CONSTRUCTION

5.1 **Authorized and qualified company representative** is responsible for :

5.1.1 Evaluating and acting in response to notification of planned construction and excavation activities on Company right of ways in accordance with [STANDARD 106.0019](#), *Land and Right of Way Encroachments*.

5.1.2 When it appears that the pipeline will be crossed with heavy equipment, the **authorized and qualified company representative** who is made aware of the crossing notifies the appropriate Region or District supervisor. Region or District supervisor notifies Technical Services who determines whether or not and to what extent the installation of temporary crossing ramps will be required. Gas Engineering-Pipeline Design may be contacted to request that a stress analysis study be conducted to determine if the proposed crossing is safe. When it is determined that ramps are required, Technical Services or District notify the excavator/developer of their responsibility and of the required cover, spacing and any other special requirements.

5.1.3 If direct contact is made with an excavator, advise the excavator that it is the excavator’s responsibility to protect the Company facilities. This is done through personal contact and/or by participation at a pre-construction planning meeting whenever possible. Document all conversations (date, time, name, etc.) in MDT KorTerra® System under “Visit Remarks” in the Completion Screen or in the Contact screen “Remarks” section.

5.1.4 Determine the work schedule, limits of the projects, and dimensions of the excavations.



Company Operations Standard Gas Standard Gas Operations & System Integrity

Prevention of Excavation Damage to Company Facilities	SCG:	184.09
---	------	--------

- 5.1.5 Schedule necessary locating, marking and stand-by/inspection of gas facilities (refer to [STANDARD 184.0200](#), *Underground Service Alert and Temporary Marking*, for temporary facility marking instructions),
- 5.1.6 Arrange for necessary cutting and reconnecting services.
- 5.2 **Line locator** locates and marks Company facilities in accordance with [STANDARD 184.0200](#), *Underground Service Alert and Temporary Marking*.

Note: Mark the location of all Company **high priority subsurface installations** within ten (10) feet or less of the delineated excavation site, (refer to [STANDARD 184.0200](#), *Underground Service Alert and Temporary Marking*).
- 5.3 **Line locator** uses [Form 5153](#), *Pipeline Location Information* to record information furnished to excavators regarding methods of identifying gas pipelines.

INTERIM

**Company Operations Standard
Gas Standard
Gas Operations & System Integrity**

Prevention of Excavation Damage to Company Facilities	SCG:	184.09
--	-------------	---------------

- 5.4 **Line locator or the authorized or qualified company representative performing stand-by** determines and communicates any special precautions necessary to protect Company facilities. If the construction activity notification was received from other sources, inform the excavator of the Company’s participation in the USA one-call notification program and that the excavator is required to call the toll-free number at least 48 hours prior to commencing work (refer to 184.0200, *Underground Service Alert and Temporary Marking*).

6 ACTION DURING CONSTRUCTION

- 6.1 The **authorized or qualified company representative** (See Appendix A, Guidelines for Stand-by) performing stand-by shall:

6.1.1 Maintain **continuous stand-by** during periods of known construction causing exposure or possible exposure (within 10 feet) of high-pressure (greater than 60 psig) pipelines. **Note:** Notify the Measurement Supervisor if an excavation is located within 10 feet of a regulator station

6.1.2 After limits of excavation are verified or pipe is exposed, the **authorized or qualified company representative** performing surveillance observes the job at a frequency necessary to determine that Company facilities are not damaged and are adequately protected, and that shoring is adequate to retain the pipeline in place.

6.1.3 Maintain **continuous stand-by** during periods of known backfill and compaction operation. Care shall be taken to ensure that existing company facilities that are located within the area of the backfilling operations and still buried are properly located, marked, and protected from damage. The authorized and qualified company representative must ensure the pipeline is not affected by vehicular loading during or after a backfill/compaction operation and must ensure proper crossing ramps are installed if necessary. See Section 5.1.2 of this Gas Standard for additional details.

6.1.4 When a project or activity handoff occurs between multiple inspectors or pipeline crews that are involved with the excavation or backfilling operations, caution shall be taken to ensure that proper knowledge transfer has taken place before any activities over the pipeline commence. Knowledge transfer between Operators, Foreman, Inspectors, Employees, and Supervisors that are on site during construction should include but shall not be limited to the following:

- Conducting a meeting and a site walk to discuss the proposed excavating or backfilling activities taking place
- Conducting a complete review of the construction drawings
- Reviewing the construction notes

Company Operations Standard Gas Standard Gas Operations & System Integrity

Prevention of Excavation Damage to Company Facilities	SCG:	184.09
--	-------------	---------------

- Ensuring all company facilities are marked within the work site.
 - Potholing or probing any company facility that cannot be verified in the field per the drawings
- 6.1.5 Arrange additional protective measures for plastic piping:
- 6.1.5.1 Protect buried plastic piping against damage when the support for a segment of the line is, or may be disturbed by:
- Vibrations from heavy construction equipment, trains, trucks, buses, or blasting.
 - Impact forces by vehicles.
 - Earth movement.
 - Apparent future excavations near the pipeline
 - Other foreseeable outside forces which may subject that segment to bending stress.
- 6.1.5.2 Take appropriate steps as soon as feasible to provide permanent protection.
- 6.1.6 Be responsible for any potholing work to locate high pressure pipelines. All potholing shall be accomplished by the use of hand tools or other approved methods.
- 6.1.7 Give special attention to excavations around threaded couplings steel pipelines both during and after excavation, since it may have been used for polyethylene insertion conduits.
- 6.1.8 Report an indication that company facilities are or may become endangered to the excavator's supervision and the project inspector of the agency responsible for the work.
- 6.1.9 If Company facilities are endangered, or made inaccessible or a safety-related pipeline condition is suspected report the condition to the excavator's supervisor and to the project inspector. If the excavator fails to take corrective action, immediately notify local supervision to take appropriate actions.
- 6.1.9.1 Arrange, without delay, for the Company to do whatever is necessary to make gas facilities accessible and safe for workers and/or the public
- 6.1.9.2 Advise the excavator that they will be billed for all costs incurred to protect Company facilities
- 6.1.9.3 Notify Claims and request their assistance

**Company Operations Standard
Gas Standard
Gas Operations & System Integrity**

Prevention of Excavation Damage to Company Facilities	SCG:	184.09
--	-------------	---------------

6.1.9.4 Advise permit agency of problem

6.1.9.5 When a suspected safety-related pipeline condition is discovered during surveillance, notify local supervision immediately. Refer to [STANDARD 183.06](#), *Region Reports of Safety Related Pipeline Condition*.

6.2 If the pipeline is exposed, a Pipeline Condition and Maintenance Report must be completed. See Company Form Instruction 677-1.

6.3 Power-operated or power-driven excavation or grading shall not be allowed closer than two feet from any unexposed portion of pipeline or valve. The **authorized and qualified company representative** performing stand-by shall mark and maintain accessible gas valves on high pressure gas facilities.

6.4 If a potentially hazardous leakage occurs, and it is determined by the **authorized and qualified company representative** that the leak may endanger life, or cause serious bodily harm or damage to property, the **authorized and qualified company representative** shall immediately report to, or request dispatch to report to, other appropriate authorities by calling the 911 emergency telephone number for emergency personnel response and assistance. See [STANDARD 183.03](#), *Field Guidelines - Emergency Incident* – Section 2. Gas Leak Emergencies, for assessment and response criteria.

Note: This section applies to leaks from damage caused by others and leaks that are the result of the Company excavating over its own facilities.

6.5 **Authorized and qualified company representative** also immediately notifies, as appropriate, the excavator’s supervisor and the project inspector of the agency for whom the work is being performed and **District supervisor**.

6.6 When **authorized and qualified company representative** enter an excavation that requires shoring, has shoring or sloping, at least one person trained in first aid (may be either a Company or a contract person) must be at the job site while the Company employee is in the excavation. Company employees are responsible for assuring that shoring or sloping systems are in accordance with Company standards. See [STANDARD 223.0140](#), *Excavating, Shoring and Sloping*.

7 ACTION AFTER BACKFILL OR CONSTRUCTION

7.1 After the construction activity, verify the integrity of the pipeline(s) and the accessibility of the valves.

7.2 If an **authorized and qualified company representative** finds physical evidence of encroachment involving excavation that the Company did not monitor near a high pressure gas facility, the Company must either excavate the area near the

**Company Operations Standard
Gas Standard
Gas Operations & System Integrity**

Prevention of Excavation Damage to Company Facilities	SCG:	184.09
--	-------------	---------------

encroachment or conduct an above ground survey. The Company must excavate, and remediate, any indication of coating holidays or discontinuity warranting direct examination. See [STANDARD 167.0214](#), *Preventive and Mitigative Measures*.

- 7.3 When a foreign subsurface installation is installed across or closely adjacent to a high pressure gas facility using the boring or jacking method, without potholing over the facility, and coating or pipeline damage is suspected, **District supervision** take appropriate action to investigate and alleviate the suspect condition. Refer to [STANDARD 106.0019](#), *Land and Right of Way Encroachments*.
- 7.4 After third party construction, **authorized and qualified company representative** performing stand-by inspects valves identified on Company reference drawings to assure continued accessibility. Without delay, arrange any work necessary to provide access to valves made inaccessible by the construction work.

8 STREET RESURFACING

8.1 Prior to Street Resurfacing

- 8.1.1 **Technical Services** obtain, or attempt to obtain, commitment from the agency for advance notification through the USA of resurfacing projects.
- 8.1.2 **Technical Services** request the agency to include in specifications or contracts with paving contractors (or specifications for the agency's personnel if the agency directly performs the work) the requirement that USA be notified two working days in advance of any resurfacing project. If agency is unwilling or unable to commit to notification of resurfacing projects in advance of the work, establish a schedule for Company personnel to periodically contact the agency to determine the status of these projects.
- 8.1.3 If any critical valves or other street-level facilities are identified within the project, **Technical Services** makes copy of atlas sheet and highlight the identified facilities. Identify project by street name, agency project descriptor or other identifier.
- 8.1.4 Depending on local communication arrangements between the Company and the agency, **Line locator** receive or obtain information of the project starting time and dispatch work order and atlas sheet. If necessary, patrol at regular intervals to assure Company is aware of the actual re-paving activity starting date.
- 8.1.5 The work order is completed after the project work is completed and access to critical valves is verified by the **Line locator**.

**Company Operations Standard
Gas Standard
Gas Operations & System Integrity**

Prevention of Excavation Damage to Company Facilities	SCG:	184.09
--	-------------	---------------

8.1.6 If no critical valves or other street-level facilities are within the limits of the re-paving project, no further surveillance is required under this Standard.

8.2 During Street Resurfacing Work

8.2.1 **Line locator** observes the activity and takes immediate steps necessary to make accessible any paved-over critical valves or other street-level facilities.

9 SUBSURFACE BLASTING

9.1 Upon notification of surface blasting, **District supervision** take appropriate steps to ensure Company pipelines are not damaged and potential adverse effects are minimized.

9.1.1 The effect of blasting on pipelines depends primarily on the explosive energy released, the distance from the pipe, and the physical parameters of the pipe.

9.1.2 Before and immediately after the blasting, schedule a leakage survey of all pipelines within 200 ft. of the detonated charge.

9.2 When blasting will take place in proximity to Company pipelines operating at a hoop stress less than 20% SMYS, **District supervision** enlists the assistance of **Technical Services** to determine the amount (weight) of explosive charges to be used at each location and determines the distance from the nearest pipeline.

9.2.1 If the explosive charge to be used is more than 10 pounds, or is closer than 50 feet to the pipeline, **District supervision** informs **Technical Services** who will assess the conditions and determine the appropriate measures to protect the pipeline including contacting **Gas Engineering-Pipeline Design**, if necessary.

9.2.2 **District supervision** and/or **Technical Services** determine isolation valve locations or other operating methods of control to be used in event of pipeline damage.

9.3 When blasting will take place in proximity to pipelines operating at 20% SMYS or greater, or in other circumstances not included above, **District supervision** informs **Technical Services** who contacts **Gas Engineering-Pipeline Design** to assess the conditions and determine the appropriate measures to protect the pipeline, if necessary.

**Company Operations Standard
Gas Standard
Gas Operations & System Integrity**

Prevention of Excavation Damage to Company Facilities	SCG:	184.09
--	-------------	---------------

10 OPERATOR QUALIFICATION COVERED TASKS

(See [STANDARD 167.0100](#), *Operator Qualification Program*, Appendix A, *Covered Task List*)

- 10.1 **Task 1.2** – 49 CFR 192.327 – Maintaining minimum cover over pipelines.
- 10.2 **Task 5.1** – 49 CFR 192.614(c)(5) – Locating and temporarily marking buried pipelines in the area of excavation activity.
- 10.3 **Task 5.2** – 49 CFR 192.614(c)(6) – Inspection and standby for prevention of damage to pipelines.

11 RECORDS

- 11.1 **Line locator** documents all third party construction activities in MDT KorTerra® System under “Visit Remarks” in the Completion Screen or in the Contact screen “Remarks” section.
- 11.2 **Authorized and qualified company representative performing stand-by** documents all third party subsurface crossings and exposures of Transmission- and Storage-operated high pressure pipelines on [Form 677-1](#), *Pipeline Condition and Maintenance Report*. Forward completed copies of [Form 677-1](#) to **Gas Engineering-Pipeline Integrity** – (ML: GT12B6).
- 11.3 **Line locator or authorized and qualified company representative performing stand-by** documents all exposed Distribution-operated high pressure pipelines on Form677-1 *Pipeline Condition and Maintenance Report*. Forward completed copies of [Form 677-1](#) to **Gas Engineering-Pipeline Integrity** – (ML: GT12B6).

**Company Operations Standard
Gas Standard
Gas Operations & System Integrity**

Prevention of Excavation Damage to Company Facilities	SCG:	184.09
--	-------------	---------------

Appendix A. Guidelines for Stand-by

1. **Authorized and qualified company representative** are responsible for making the excavator aware of their responsibility to **CAREFULLY HAND DIG** within 2 feet of the markout, prior to crossing or operating power-operated or power-driven equipment near high pressure gas facilities.
2. **Authorized and qualified company representative** will inspect the excavation site to make sure Company facilities are not damaged and are adequately protected, and are adequately supported. This will include entering the trench to inspect the pipe and wrap for damage.
3. Plastic pipelines shall be inspected for gouges and coated steel pipelines shall be inspected for coating damage, dents, and gouges before the exposed pipelines are backfilled.
4. Any damage to the pipeline will require IMMEDIATE inspection by a Supervisor or authorized and qualified company representative
5. **Authorized and qualified company representative** are responsible for **insuring** that the excavator **uses acceptable** shading and backfill materials and that proper cover and separation from Company facilities are maintained.
6. Special attention shall be given to excavations around threaded coupling steel pipelines both during and after excavation, since both may have been used for polyethylene insertion conduits.
7. **Authorized and qualified company representative** are responsible for re-wrapping coated steel pipelines when necessary.
8. If **authorized and qualified company representative** do not receive the necessary cooperation from the excavator and problems are encountered when trying to enforce these procedures, call the **Region** or **District FOS**, or his designated representative.
9. Appropriate documentation shall be prepared per Section 11.



Company Operations Standard Gas Standard Gas Operations & System Integrity

Prevention of Excavation Damage to Company Facilities	SCG:	184.09
--	-------------	---------------

NOTE: Do not alter or add any content from this page down; the following content is automatically generated.

Brief: The document was revised in sections 6.1.3 and 6.1.4 for the purpose of encouraging further communications between all parties on the job to make them aware of the steps necessary to prevent damage to company facilities while construction activity is on-going. The communication is especially necessary when new personnel are added to the crew or when the job is handed off to another crew. Added section 2.5 to reference GS 184.0175.

Document Profile Summary	
Responsible Person:	██████████
Published On:	09/23/2013
Last Full Review Completed On:	09/23/2013
Writer:	██████████
Document Status:	Active
Document Type:	GAS
Category (Prior FCD system only):	
If Merged, Merged To Document Number:	
Utility:	SoCalGas
Department:	Gas Operations & System Integrity
Number of Common Document (if applicable):	G8122
Contains OPQUAL Covered Task:	Yes
Part of SoCalGas O&M Plan:	Yes
Part of SDG&E O&M Plan:	No
Last O&M Review date:	2017-09-25
O&M 49 CFR Codes & Impacted Sections of Document:	192.614(c)(6ii): 9, 9.1.2 192.614(c)(6): 5, 6 192.614(c)(5): 5 192.614(c)(4): 5 192.614(c)(3): 5 192.614(c)(2): 5 192.614(a): Entire Doc 192.613(a): 6
Part of Non-O&M Parts 191-193 Plan	Yes
Non-O&M 49 CFR Codes & Impacted Sections of Document	192.935(d): 5 192.935(b): 5
Part of Distribution IMP (DIMP)	No
Part of Transmission IMP (TIMP)	Yes
Part of Storage IMP (SIMP)	No
Impacts GO112F	No
GO112F Codes & Impacted Sections of Document	
Impacts GO58A	No
GO58A Codes & Impacted Sections of Document	
Impacts GO58B	No
GO58B Codes & Impacted Sections of Document	
Indices/Binders in Which Document is Filed:	TRAN, TIMP2, STOR, PSEP, MS, LSDP, DISTM
NOP Learning Module (LM) Training Code:	NOP00411